

ICOEST BOOK OF PROCEEDINGS

BELGRADE - SERBIA

28 SEPTEMBER - 2 OCTOBER 2016

ISBN: 978-605-66262-9-6

icoest.eu

ORGANIZERS



SUPPORTED BY



PARTNERS



Edited by

Prof. Dr. Özer Çınar

Published, 2016

This work is subject to copyright. All rights are reserved, whether the whole or part of the material is concerned. Nothing from this publication may be translated, reproduced, stored in a computerized system or published in any form or in any manner, including, but not limited to electronic, mechanical, reprographic or photographic, without prior written permission from the publisher.

www.icoest.eu

info@icoest.eu

The individual contributions in this publication and any liabilities arising from them remain the responsibility of the authors.

The publisher is not responsible for possible damages, which could be a result of content derived from this publication.

ISBN: 978-605-66262-9-6

SCIENTIFIC COMMITTEE

Prof.Dr. Abdulrezzak Memon

International University of Sarajevo

Prof.Dr. Adisa Parić

University of Sarajevo

Prof.Dr. Adnan Çelik

Selçuk University

Prof.Dr. Ahmet Karagündüz

Gebze Technical University

Prof.Dr. Ana Vovk-Korže

University of Maribor

Prof.Dr. Ayşe Filibeli

Dokuz Eylül University

Prof.Dr. Barış Çallı

Marmara University

Prof.Dr. Bestami Özkaya

Yıldız Technical University

Prof.Dr. Cumali Kınacı

Istanbul Technical University

Prof.Dr. Dragan Vinterhalter

University of Belgrade

Prof.Dr. Dragutin T. Mihailović

University of Novi Sad

Prof.Dr. Edina Muratović

University of Sarajevo

Prof.Dr. Erkan Şahinkaya

Istanbul Medeniyet University

Prof.Dr. Esad Prohic

University of Zagreb, Croatia

Prof.Dr. Halil Hasar

Fırat University

Prof.Dr. Hasan Merdun

Akdeniz University

Prof.Dr. Jasna Huremović

University of Sarajevo

Prof.Dr. Lada Lukić Bilela

University of Sarajevo

Prof.Dr. Lukman Thalib

Kuwait University

Prof.Dr. M. Asghar Fazel

University of Environment

Prof.Dr. Mehmet Çakmakçı

Yıldız Technical University

Prof.Dr. Mehmet Kitiş

Süleyman Demirel University

Prof.Dr. Özer Çınar

Yıldız Technical University

Prof.Dr. Rifat Skrijelj

University of Sarajevo

Prof.Dr. Samir Đug

University of Sarajevo

Prof.Dr. Sinan Uyanık

Harran University

Prof.Dr. Suad Bećirović

Int.University of Novi Pazar

Prof.Dr. Šemsudin Plojović

International University of Novi Pazar

Prof.Dr. Tanju Karanfil

Clemson University

Prof.Dr. Ubeyde İpek

Fırat University

Prof.Dr. Vedat Uyak

Pamukkale University

Prof.Dr. Yücel Taşdemir

Uludağ University

Assoc. Prof.Dr. Abdurrahman Akyol

Gebze Technical University

Assoc. Prof.Dr. Elma Elfić-Zukorlić

International University of Novi Pazar

Assoc. Prof.Dr. Mehmed Meta

International University of Novi Pazar

Assoc. Prof.Dr. Mehmet Sinan Bilgili

Yıldız Technical University

Prof.Dr. Mostafa Jafari

Res. Inst.of Forests and Rangelands

Assoc. Prof.Dr. Nuran Cıkcıkoğlu Yıldırım

Tunceli University

Assoc. Prof.Dr. Nusret Drešković

University of Sarajevo

Assoc. Prof.Dr. Serdar Kara

Gebze Technical University

Assist. Prof.Dr. Ahmad Talebi

University of Environment

Assist. Prof.Dr. Gökhan ÖnderErgüven

Tunceli University

Assist. Prof.Dr. Mostafa Panahi

Islamic Azad University

Assist. Prof.Dr. Sasan Rabieh

Shahid Beheshti University

Assist. Prof.Dr. Ševkija Okerić

University of Sarajevo

ORGANIZATION COMMITTEE**Conference Chairs****Prof. Dr. Özer Çınar***Yıldız Technical University***Members of the Committee****Prof. Dr. M. Asghar Fazel (Co-Chairman) – *University of Environment*****Prof. Dr. Samir Đug – *University of Sarajevo*****Assist. Prof. Dr. Sasan Rabieh – *Shahid Beheshti University*****Assist. Prof. Dr. Ševkija Okerić – *University of Sarajevo*****Assist. Prof. Dr. Nusret Drešković – *University of Sarajevo*****Assist. Prof. Dr. Ranko Mirić – *University of Sarajevo*****Musa Kose – *Zenith Group Sarajevo*****Ismet Uzun – *Zenith Group Sarajevo*****Alma Ligata – *Zenith Group Sarajevo*****Ajdin Perco – *Faktor.ba***

WELCOME TO ICOEST 2016

On behalf of the organizing committee, we are pleased to announce that the II International Conference on Environmental Science and Technology is held from September 28 to October 2, 2016 in Belgrade, Serbia. ICOEST 2016 provides an ideal academic platform for researchers to present the latest research findings and describe emerging technologies, and directions in Environmental Science and Technology. The conference seeks to contribute to presenting novel research results in all aspects of Environmental Science and Technology. The conference aims to bring together leading academic scientists, researchers and research scholars to exchange and share their experiences and research results about all aspects of Environmental Science and Technology. It also provides the premier interdisciplinary forum for scientists, engineers, and practitioners to present their latest research results, ideas, developments, and applications in all areas of Environmental Science and Technology. The conference will bring together leading academic scientists, researchers and scholars in the domain of interest from around the world.

ICOEST 2016 is the oncoming event of the successful conference series focusing on Environmental Science and Technology. The scientific program focuses on current advances in the research, production and use of Environmental Engineering and Sciences with particular focus on their role in maintaining academic level in Science and Technology and elevating the science level such as: Water and waste water treatment, sludge handling and management, Solid waste and management, Surface water quality monitoring, Noise pollution and control, Air pollution and control, Ecology and ecosystem management, Environmental data analysis and modeling, Environmental education, Environmental planning, management and policies for cities and regions, Green energy and sustainability, Water resources and river basin management.

The conference's goals are to provide a scientific forum for all international prestige scholars around the world and enable the interactive exchange of state-of-the-art knowledge. The conference will focus on evidence-based benefits proven in environmental science and engineering experiments.

Best regards,

Prof. Dr.Özer ÇINAR

INDEX

<u>PAPER NAME</u>	<u>PAGE</u>
HAY YIELD PERFORMANCE OF SOYBEAN GENOTYPES FROM DIVERSE ORIGINS <i>(Esvet Acikgoz, Abdurrahim Tanju Goksoy, Aysen Uzun, Mehmet Sincik)</i>	7
EVALUATION OF THE STRUCTURAL AND PLANT LANDSCAPE DESIGNS OF THE EUROPEAN TOWN SQUARES <i>(Nurhan Kocan, Nuket Ankarali, Fatma Sancakdar, Hakan Ruzgar, Tugba Akyuz)</i>	11
STUDY OF RHEOLOGICAL BEHAVIOR OF MINERAL PROCESSING TAILINGS IN SURFACE PASTE TECHNOLOGY <i>(Atac Bascetin, Deniz Adiguzel, Orhan Ozdemir, Serkan Tuylu)</i>	20
BIOGAS EFFICIENCY, LEACHATE QUALITY AND WASTE STABILIZATION IN ANAEROBIC LANDFILL BIOREACTORS <i>(Cevat Yaman, Yusuf Kucukaga, Abdurrahman Akyol, Serdar Kara)</i>	25
POTENTIAL ECOLOGICAL RISK ASSESSMENT OF HEAVY METAL AT SEDIMENT <i>(Arife Simsek, Gulfem Bakan)</i>	31
SHORT-TERM EFFECT OF NANOPARTICLES ZNO AND TIO₂ ON DAPHNIA MAGNA <i>(Didem Gokce)</i>	36
RELATIONSHIPS BETWEEN NANOPARTICLE TIO₂ AND DAPHNIA MAGNA POPULATION DYNAMICS <i>(Didem Gokce)</i>	43
CATALYTIC GASIFICATION OF GALACTURONIC ACID AS A MODEL COMPOUND FOR HEMICELULOSES <i>(Dilek Selvi Gokkaya, Mehmet Saglam, Mithat Yuksel, Levent Ballice)</i>	50
BIOHYDROGEN PRODUCTION FROM MOLASSES: EFFECT OF PHOTOOXIDATION TO MOLASSES <i>(Nevim Genc, Ismail Ozbay, Elif Durna)</i>	59
OUTDOOR AIR POLLUTION INCREASED WITH URBAN TRANSFORMATION IN ISTANBUL ANATOLIAN SIDE <i>(Esin Bozkurt, Gussun Gunes)</i>	64
EFFECTS OF USING PURE ECO-FRIENDLY LUBRICANTS IN PUMP BEARINGS INSTEAD OF TRADITIONAL MINERAL LUBRICANTS <i>(Fatih Dokme, Muzaffer Turan)</i>	70

ECOLOGICAL AND SOCIO-ECONOMIC EFFECTS OF INVASIVE SPECIES RAPANA VENOSA IN THE BLACK SEA ECOSYSTEM <i>(Hacer Saglam, Ertug Duzgunes)</i>	78
A CALCULATION METHOD FOR DETERMINATION OF HOUSEHOLD SOLID WASTE TARIFFS FOR MUNICIPAL ADMINISTRATIONS <i>(Ibrahim Demir, Yavuz Soysal, Esra Tinmaz Kose)</i>	85
MEDICAL WASTE MANAGEMENT IN TURKEY <i>(Osman Atilla Arikan, Izzet Ozturk, Ibrahim Demir, Kadriye Elif Macin)</i>	90
RELATION OF BUILT AND NATURAL ENVIRONMENT'S EFFECTS ON PUBLIC HEALTH <i>(Muhammed Fatih Cetintas)</i>	98
MEIOFAUNA AS AN ENVIRONMENTAL BIO-INDICATOR IN MARINE ECOSYSTEMS <i>(Murat Sezgin, Derya Urkmez, Vera Vukanic)</i>	104
ZOOPLANKTON STUDIES IN THE BOKA KOTORSKA BAY (SOUTHERN ADRIATIC) – LARVAE <i>(Vera Vukanic, Murat Sezgin)</i>	107
INTEGRATION OF PHOTOCATALYTIC AND MEMBRANE DISTILLATION HYBRID PROCESSES FOR TEXTILE WASTEWATER TREATMENT <i>(Nadir Dizge, H. Cengiz Yatmaz, M. Sezen Kurt)</i>	114
ECOTOXICOLOGICAL INVESTIGATION OF THREE NANO-METAL OXIDES (HFO₂, SIO₂, ZNO) ON FOUR TROPHIC LEVELS (BACTERIA, YEAST, MOLD AND ALGAE) AND THEIR BIODEGRADABILITIES <i>(Nefise Erdincmer, Delia Teresa Sponza)</i>	119
PULP AND PAPER WASTEWATER TREATMENT BY USING CHEMICAL AND BIOLOGICAL PROCESSES: CHEMICAL COAGULATION FOLLOWED BY INNOVATIVELY DESIGNED CSTR <i>(Abdullah Kizilet, Merve Yurdakul, Dilda Gumuscu, Amar Cemanovic, Ozer Cinar)</i>	128
COMPARISON OF PERFORMANCE OF CONVENTIONAL MEMBRANE BIOREACTOR WITH DYNAMIC MEMBRANE BIOREACTOR <i>(Mehmet Akif Veral, Abdullah Kizilet, Ozer Cinar)</i>	136
ISOTHERM AND KINETIC MODELLING OF AZO DYES ADSORPTION <i>(Onur Isik, Ibrahim Demir, Ahmet Yuceer, Ozer Cinar)</i>	145
INVESTIGATION ON THE CHARACTERISTICS AND MANAGEMENT OF DENTAL WASTEWATER IN TEHRAN, IRAN <i>(Majid Bahramian, Ozer Cinar, Naser Mehrdadi, Mehmet Akif Veral)</i>	152

INVESTIGATION OF DEGRADABILITY OF IBUPROFEN FROM WASTEWATER BY USING ADVANCED OXIDATION PROCESS <i>(Sevde Ustun Odabasi, Hanife Buyukgungor)</i>	159
INVESTIGATION OF DOMESTIC WASTEWATERDISCHARGE PERFORMANCE OF SUBMARINE OUTFALLS IN RIZE PROVINCE AND ALTERNATIVE PROPOSALS <i>(Ozge Koksal, Tolga Ayeri, Yuksel Ardali)</i>	166
DEEP SEA OUTFALL OF NATURAL GAS FIRED COMBINED CYCLE POWER PLANT COOLING WATER APPLICATION AND MODELING <i>(Tolga Ayeri, Yuksel Ardali)</i>	173
PRODUCTION OF BIO-PELLETS DERIVED FROM SAWDUST AND CRUDE GLYCEROL <i>(Veli Gokhan Demir, Pasa Yaman, Mete Oguzhan Efe, Hayrettin Yuksel)</i>	179
BIODIESEL PRODUCTION USING WET AND DRY PURIFICATION METHODS <i>(Veli Gokhan Demir, Baybars Ali Fil, Vedat Demirtas, H. Serhad Soyhan)</i>	187
UTILIZATION OF OLIVE CAKE IN BIOFUEL INDUSTRY AS PELLET AND BRIQUETTE FUELS <i>(Veli Gokhan Demir, Pasa Yaman, Hayrettin Yuksel)</i>	196
ZOOPLANKTON STUDIES IN THE BOKA KOTORSKA BAY (SOUTHERN ADRIATIC) – LARVAE <i>(Vera Vukanic, Murat Sezgin)</i>	204

Hay Yield Performance of Soybean Genotypes From Diverse Origins

Esvet Acikgoz¹, Abdurrahim Tanju Goksoy¹, Aysen Uzun¹ and Mehmet Sincik¹

Abstract

Soybean, may be grown as hay and pasture crop or ensiled with corn and sorghum for livestock. Field experiments in a Mediterranean-type climate were conducted in the 2013 growing season to evaluate DM yield and some yield components of soybean genotypes [*Glycine max* (L.) Merr.] in Bursa, Turkey. In the study, seventy soybean genotypes and five check cultivars were evaluated in augmented design in main (spring planting) and double cropping conditions, simultaneously. There were statistically significant differences between soybean genotypes in dry matter (DM) yield, yield components and partitioning of soybean plant parts in both main and double cropping.

Keywords: *Glycine max* (L.) Merr., forage soybean, plant components, seeding time, hay production

1. INTRODUCTION

Soybean [*Glycine max* (L.) Merr.] is a productive, high-quality warm season forage legume that can be used for hay, silage, grazing, cover crop, wildlife cover, or green manure. Recently several soybean cultivars and experimental lines have been bred for forage production (1, 2, 3).

Soybean forage yield and nutritive value varied depending on genotype, location and maturity stage at harvest (4). Munoz et al. (5) indicated when soybean pods were filled and leaves began to turn yellow, the percentages of leaves, stems, and pods were 28, 36, and 36, respectively, with a total DM yield of 12.4 t ha⁻¹. When grown for forage, Sheaffer et al. (6) found no dry matter (DM) yield differences between forage-type and grain-type soybeans cultivars, which averaged 8.8 t ha⁻¹. In the southern Great Plains Region, USA, DM yields of forage soybeans ranged from slightly less than 1 to 5.4 t ha⁻¹, depending on climatic conditions (7). In USA, forage soybean cultivars Derry, Donegal, and Tyrone produced DM yields varying from 5216 to 13900 kg ha⁻¹, depending on location and year (8). Dry matter yields of Derry and Donegal reached 7.95 t ha⁻¹ in UK conditions (9). Soybeans grown for forage averaged 9.3 and 11.3 t ha⁻¹ DM yield at R4 and R6 stages, respectively, containing 13.3% crude protein, 8.2% degradable protein, and 60.6% in vitro dry matter digestibility at three different locations with Mediterranean climates in Turkey (10).

In Mediterranean regions of Turkey, soybean can be grown as a main cropping system (spring seeding) or double cropped after cereal harvest where soybean growers generally prefer to plant soybean for grain immediately following winter cereal harvest (mostly barley or wheat).

Little is known about variation of morphological traits, DM yields, and plant components of different soybean genotypes under spring seeded, or double cropping conditions. The objectives of these studies were to evaluate soybean genotypes from diverse origins for some morphological traits, DM yield, and plant components in the Mediterranean-type climate of Bursa, Turkey.

2. MATERIALS AND METHODS

Field studies were conducted on irrigated experimental plots at Uludag University, Bursa, Turkey during the 2013 growing season. At a level 70 m altitude located in the coastal zone of northwest Turkey (40° 11' North, 29° 04' East), it is characterized as a Mediterranean type climate.

The specific site soil type is clay loam and classified as vertisol typic habloxert with 7.2 pH value. Soil is medium in P (73 kg ha⁻¹), and rich in K (1130 kg ha⁻¹) with 1.4 % organic matter. Long-term annual rainfall averages 579 mm with only 20% falling in the soybean growing period (April-September). Mean temperature during the growing period is 21.0 °C with relative humidity of 75%.

Experimental fields were fall moldboard plowed and cultivated level in early spring. Soybeans were not inoculated. 50 kg ha⁻¹ N-P-K fertilizer was applied uniformly after hand seeding in all growing seasons. Weed control was achieved manually. Irrigation was applied three times (V5, R2 and R5 stages) with a rotary sprinkler to maintain the soil near field capacity. Irrigation timing was estimated visually as the soil surface dried. Sunflower was the previous crop in the experimental year.

Soybean genotypes used in this study were mainly provided by IPK (Leibniz-Institute of Plant Genetics and Crop Plant Research, Germany) and collected from different countries, mostly China, Japan, USA and Russia. Some experimental lines and local genotypes from Turkey were also included. Five standard checks (Derry, Greencastle, and Laredo from USA and Yemsoy and Yesilsoy from Turkey) were added for this study. Derry, Greencastle, and

¹*Corresponding author: Department of Field Crops, Faculty of Agriculture, Uludag University, 16059 Bursa, Turkey
Turkeyesvet@uludag.edu.tr

Laredo are typical forage type soybean cultivars (Group VI) registered in USA, and Yemsoy and Yesilsoy (Group IV) are soybean cultivars registered for forage production in Turkey.

A total of 70 soybean genotypes were grown in the 2013 augmented design with five standard checks replicated in five blocks, 3 m long rows spaced 70 cm. Seeding rate was 60 seeds per row. Seeding was made on 30 April 2013 for main cropping and 16 July 2013 for double cropping.

All plots were monitored regularly and days to 50% flowering of genotypes were recorded. Forage yield data was collected at R4 stage in all experiments. Plants were hand-cut at soil surface. In the 2013 augmented trials, 0.7 m² area was cut for forage yield. Before cutting, 5 randomly selected plants from each plot were measured for plant height and branch number per plant; then each of those plants were dissected into leaflet, petiole, stem, and flower plus pods components before weighing. Components were dried and weighted again. All samples were dried at 70 °C for 48 h for DM yield determination.

Augmented design was subjected to analysis of variance for each character using MINITAB (University of Texas, Austin), MSTAT-C (Version 2.1 Michigan State University, 1991) and JUMP (version 7.0, SAS Institute Inc.) software.

3. RESULTS AND DISCUSSION

Variance analysis of the 2013 augmented study showed significant effect ($P < 0.01$ and $P < 0.05$) of check cultivars and genotypes on DM yield, plant constituents, and all characteristics measured in both main and double cropping conditions; wherein both plantings, blocks affects were not statistically significant.

Days to flower, plant height, branches per plant, and plant constituent data are presented in Table 1. To simplify interpretation of results, only average and variation limits of measured characteristics of soybean genotypes and check cultivars are summarized in that Table. There was considerable variation in flowering time among soybean genotypes. Some early soybean genotypes flowered 55 and 35 days after seeding in main and double cropping conditions, respectively, compared to later flowering genotypes (119 and 76 days).

Plant height differences between the soybean genotypes varied from 14.1 to 243.1 cm in main cropping and from 13.6 to 92.0 cm in double cropping conditions. In general, average plant height of soybean genotypes was much lower than typical forage type soybeans cultivars. However, some soybean genotypes reached heights of 243.1 cm. As may be expected, all soybean genotypes tested in double crop conditions were clearly shorter on average than main crop conditions (76.1 vs. 43.9 cm). Maximum plant heights of soybean genotypes and check cultivars were 92.0 and 111.4 cm, respectively, in double crop conditions. Very little branching was seen in some genotypes, whereas some soybean genotypes branched profusely in both main and double cropping conditions. Check cultivars had more consistent branching and were generally comparable between main and double crop plantings.

Table 1. Average and variation limits of measured traits of 70 soybean genotypes and check cultivars in main and double cropping conditions tested at maturity stage R4 (2013)

	Soybean genotypes			Check cultivars*		
	Average	Min.	Max.	Average	Min.	Max.
Main Cropping						
Days to flower (days)	72.5	55.0	119.0	94.0	77.0	110.0
Plant height (cm)	76.1	14.1	243.1	127.9	105.4	162.6
Branches/plant	3.4	0.1	7.6	3.7	2.4	4.9
Dry Matter Yield (g/row)	756.0	8.4	3227.0	1481.9	961.1	2811.4
Stem (%)	34.4	20.6	64.7	38.2	33.1	41.8
Leaflet (%)	38.1	16.3	50.6	36.5	32.3	43.8
Petioles (%)	16.7	9.1	29.8	12.2	11.4	16.3
Flower + pods (%)	10.8	3.3	30.6	13.1	11.3	25.3
Double Cropping						
Days to flower (days)	49.6	35.0	76.0	55.0	49.0	68.0
Plant height (cm)	43.9	13.6	92.0	89.6	67.6	111.4
Branches/plant	2.5	0.0	5.8	2.9	2.1	5.2
Dry Matter Yield (g/row)	279.9	14.2	751.1	615.1	443.4	806.0
Stem (%)	25.4	15.4	39.6	30.3	27.1	32.2
Leaflet (%)	42.4	27.4	57.2	45.1	38.8	52.5
Petioles (%)	13.7	6.2	20.0	14.0	11.9	17.7
Flower + pods (%)	18.5	2.7	51.0	10.6	4.7	15.1

*Average of 5 blocks

Unexpectedly wide variation occurred among soybean genotypes in DM yield per 1 m row ranging from 8.4 to 3227 g in main cropping and 14.2 to 751.1 g in the double crop system. Average DM yield of soybean genotypes was much lower than the check cultivars in main cropping (756.0 vs. 1481.9 g) and in double cropping conditions (279.9

vs. 615.1 g). However, some soybean genotypes produced higher DM yield than check cultivars in main cropping conditions supported by increased days to flower, plant height, and branches per plant. Dry matter yield of soybean genotypes sown in main cropping produced a maximum of 3227.0 g while the double cropping maximum was DM yield of 751.1 g. Some soybean genotypes exceeded check cultivars in DM yield in main cropping conditions. The DM yield of soybean genotypes and check cultivars at R4 maturity averaged approximately equal proportions of leaflet and stem material with far less yield from petioles and flower + pods especially for the check cultivars. Since the purpose of our study was to evaluate forage performance and quality characteristics, it is important to note leaflet percentage of double cropping was consistently higher than the main crop for both soybean genotypes and check cultivars, very likely due to shorter plant height and smaller stem percentage in the double cropping system. Furthermore for forage quality characteristics, double cropped soybean genotypes had nearly three fourths (74.6%) of their aerial dry matter from leaflet, petioles, and flower+pods and it was 69.7% for check cultivars. Comparatively, the main crop system had approximately two thirds (65.6%) and 61.8% of those components respectively for main soybean genotypes and check cultivars.

4. CONCLUSION

In many countries, there is renewed interest in developing new soybean grazing and feed cultivars with improved DM yield and forage value for farmers seeking high-yielding annual legumes, annual plantings to allow more intense crop rotations, and planting date flexibility to maximize labor and equipment availability. The number of soybean genotypes tested in this study is limited when compared with soybean germplasm in different gene banks. However, our study clearly showed that a considerable range of variation is available in maturity, morphological traits, and DM yields for breeders to develop new forage soybean genotypes for main and double cropping conditions.

ACKNOWLEDGMENTS

The authors gratefully acknowledge funding provided by The Scientific and Technical Research Council of Turkey (Tubitak- 1120149), and Uludag University for financial support for the Congress.

REFERENCES

- [1] R.W. Hintz, K.A. Albrecht, and E.S. Oplinger, Yield and quality of soybean forage as affected by cultivar and management practices. *Agron. J.* 84, 795-798. 1992.
- [2] T.E. Devine, and E.O. Hatley, Registration of 'Donegal' forage soybean. *Crop Sci.* 38, 1719-1720. 1998
- [3] S. Asekova, J.G. Shannon, and L. L. Jeong-Dong. The current status of forage soybean. *Plant Breed. Biotech.* 2, 334-341. 2014.
- [4] E. Acikgoz, M. Sincik, G. Wietgreffe, M. Surmen, S. Cecen, T. Yavuz, C. Erdurmus, and A. T. Goksoy. Dry matter accumulation and forage quality characteristics of different soybean genotypes. *Turk. J. Agric. For.*, 37, 22-32. , 2013
- [5] A. E. Munoz, E. C. Holt, and R. W. Weaver, Yield and quality of soybean hay as influenced by stage of growth and plant density. *Agron. J.* 75, 147-148. 1983.
- [6] C. C. Sheaffer, J. H. Orf, T. E. Devine, and J. G. Jewett. Yield and quality of forage soybean. *Agron. J.* 93, 99-106. 2001.
- [7] S. C. Rao, H. S. Mayeux, and B. K. Northup. Performance of forage soybean in the southern Great Plains. *Crop Sci.* 45, 1973-1977. 2005.
- [8] V. Nayigihugu, W. Kellogg, D. Longer, Z. Johnson, and K. Anschutz. Performance and ensiling characteristics of tall growing soybean lines used for forage. *Anim. Sci. Dep. Rep. 470.* Arkansas Agric. Exp. Stn., University of Arkansas, Fayetteville, USA, pp 142-147. 2000.
- [9] J. M. Koivisto, T.E. Devine, G. P. F. Lane, C. A. Sawyer, and H. J. Brown. Forage soybeans [*Glycine max* (L.) Merr.] in the United Kingdom: Test of new cultivars. *Agronomie*, 23, 287-291. 2003.
- [10] E. Acikgoz, M. Sincik, M. Oz, S. Albayrak, G. Wietgreffe, Z. M. Turan, A.T. Goksoy, U. Bilgili, A. Karasu, O. Tongel, and O. Canbolat. Forage soybean performance in Mediterranean environments. *Field Crops Res.* 103, 239-245 2007.

BIOGRAPHY:

I am a professor of Field Crops at the Uludag University, Bursa, and mainly studying on plant breeding. I have authored or co-authored more than 150 textbooks, scientific and technical papers and farmes bulletin, several articles 50 of which have been published in the current journals, or presented in the international meeting. I received the "Distinguished Young Scientist Award" from Scientific and Technical Research Council of Turkey in 1983, "Science Award" from Chamber of Agricultural Engineer of Turkey in 2000, "Distinguished Research Award" from Scientific and Technical Research Council of Turkey in 2001.

Evaluation of the Structural and Plant Landscape Designs of the European Town Squares

*Nurhan Kocan¹, Nuket Ankarali¹, Fatma Sancakdar¹,
Hakan Ruzgar¹, Tugba Akyuz¹*

Abstract

Urban squares are urban public places which have become an important component of the city life with different functions and forms from the formation of the city until to today. The people of the city gathered in these places and social culture had the opportunity to express themselves in here. From this point of squares are a landmark that reflects the city's culture and identity. Squares carry different identity and form according to the area they are located in and socio-cultural structure of the community. Also physical value of the square and qualifications of the elements have played an important role in the constitution of the square in terms of the place design and as active character in the environment. In this study, visual and functional effects of the squares on the formation of the urban texture; priority use of the structure, plant and water elements forming the structural design of the square and effects of these items on the form and use were examined. Obtaining common data and information related to the design preferences of the squares selected from various European cities is the aim of the work. Selected samples squares have been examined via of the layout plans of the area, photographs and photos obtained from the Google Earth website. Freehand drawing technique was used to draw of the design and to visualize three dimensional in the work as method. The spatial analyses of the squares have been made via of these data. It is concluded that facades of the buildings that make up the square, structural and plant design, urban reinforcement, monumental elements and other landscape elements are important criterion in determining of the formal qualifications of the square and so they affect the use of the area.

Keywords: *Square, urban public place, landscape design, Europe.*

1. INTRODUCTION

Squares become the multi-purpose spaces from history to present for people's meeting, gathering, relaxation and recreation facilities and to share the events about the people and the city and to follow each other (Inceoğlu, 2007). Squares play an important role in the life of the city structure and functions of different structural forms as an urban public space. Socially significant all events have taken place in these places and they have been witness of the urban memories and events. Squares have gained different identities according to the geographical and sociological structure of the society that they are located in time.

Squares are living areas as integral part of urban structure and the city life where people come together for various purposes such as gathering, meeting and entertainment and cultural, recreational and social activities. Squares are places where various social and cultural classes have different features recognize each other and they allow you to communicate other peoples and to share people's self-expression and experiences. They include the polyphony. Squares involving all sections of the community are also a landmark in the urban fabric, they reflecting the city's culture and identity (Sertkaya, 2011).

Throughout history squares have been the most common used places for physical contribution to the city and the cultural and social functions. In this context squares have had their own unique qualities from the past to present. These qualities have taken shape according to the physical and cultural characteristics of the city, the scale of city, and their purpose. They have impact on the environment (Sertkaya, 2011). The missing of spatial features of the squares can cause decrease of the relationship established with the city and in users. The qualifications of squares must be determined to perform the occurrence of pedestrian use and to contribute to the urban life and these need to be introduced in the new design.

The visual and functional effects, the design of squares, plant and water use items and priorities and the effects of these items on the form and the squares selected in European cities were examined in this study. To gain common

¹ *Bartın University Faculty of Forestry Department of Landscape Architecture
e-mail:nurhankocan@mynet.com*

data and design preferences related to squares selected from various European cities in light of the information is the aim of the study. The physical, cultural and social factors play a role in shape and formation of the squares. Urban design elements such as natural effects, artificial effects, concrete effects and abstract effects determine the squares (Yazar, 2006).

Squares define the focus of the urban structure. Therefore squares allow a user living permanently in the city and the people who visit the city for a temporary period to interact with each other and with the city. These areas offer equal opportunity to people to use of the city and they create a common platform for various activities. Therefore squares have effective ground for human interaction and communication. Therefore they are important for determining the social and cultural character and identity of the city (Aşıkoğlu, 2000).

Human factor is the one of the best cause to draw the attention of the people to the squares. The number of people using the area will increase the attractiveness of the area for other users. In addition the high visual quality, walking, resting areas and appropriate arrangements for the events and also other features make the place attractive for city dwellers. In this context the aim of the regulation of the squares are to increase their ability to come together in larger groups in the open area (Giritlioğlu, 1991).

According to a city Mougtn; residential areas of public buildings, places of great ceremony, the main collection and dissemination venues, leisure and entertainment venues located around the building theater, cinema, restaurants, cafes and so on shopping and market places, shopping centers, traffic junctions around the venues and related sites reveal the diversity of area. One of the study's objectives is to help for arrangements that can be taken towards shaping a better life in urban areas.

2. MATERIAL-METHOD

In this study, visual and functional effects of the square in urban structure, plants and water priorities formation of these, structural design challenge and effects of these items on the form and use were examined. Historical process, the determination factors of the function, concept and examples, the literature has been used in study. Square examples chosen from the main city in Europe were examined. The selection of the example; different dimensions have been carried past to present; commercial, religious, cultural and architectural qualities; different activities have been had (functional diversity) and the perception of space definition have been effective.

The structural, plant design criteria and water use have been discussed with Google Earth image and plan obtained from the photo. Freehand drawing techniques used for drawing of the designs and 3D visualize. The spatial analysis of the selected sample was made in the light of these data. Schematic representation and public preferences of the selected squares revealed as a result of the study. Assessing of the square formation analysis tables is created. The relationship of the squares with the urban structure, social life and physical environment has been determined. Water, plant and statue preference has been identified.

3. FINDINGS

Squares have been used effectively. Social, cultural, political and commercial purposes go here. This is briefly urban life. Fountains or water and statues have been used frequently to organize areas and to attract the people to the square. The activity is being important vitality of the square as well as visual appeal. To watch demonstrators in the square, listen to musicians, relax, eat and drink something, chat with people, to participate various activities in the surrounding buildings are some activities happen in the squares.

The challenge of the squares that is free to take activities. So the public interest in there. Apart from this the ground floor of the buildings surrounding the square is used as a cafe or restaurant. In this way, the square is formed by introducing a new showcase; it allows users to stay informed.

In this context, squares are platform for social interaction in urban life. Class, ethnicity, age and available to everyone living in the city without distinction of sex to different people in the community come together in these areas is important in terms of communication. Squares are important for landscape architecture in terms of establishing the ecological relationship between the natural and structural elements.

The physical value of the square, the nature of its constituent elements play important role for the design also gaining an active character in the space environment. These places are gaining importance in the cultural saturation as well as providing psychological relief. In these context facades of buildings forming squares, plants, monuments and various landscape elements in square is an important criterion determining the nature of the square.

The features of equipment in square affect the formation of the square and use. The landscape elements such as floor coverings, water element, lighting elements and monuments are important to establish the existence of square and to perform functions. Water element is one of the most important elements in the square design.

Water element located in squares in various forms and shapes by participating functions in the area passively or actively sometimes they serve as a member entertaining and exciting, sometimes relaxing. Water fountains or related regulations used to meet both functional and aesthetic requirements in pedestrian circulation, node as remaining or arrangement elements.

Jet water element placed on a pedestrian axis or node in urban square can provide focus and landmark character of the space. Also they provide noise control and encourage use of the place and increase value of landscape element. Water adds softness to the place, it reflects the other elements of the design thanks to the reflective surfaces, it ensures aquatic environment.

Water is also suitable for creating an atmosphere that shows mysterious caves in the capture of light and shadow reflections. The purpose in use of water is to gain freshness and vitality to the environment. Water in different civilizations has always supported the landscape. Water improves the spatial quality by creating attractive and spacious area. Water has become a visual and spatial component by structuring and organizing the cultural landscape. So it will further strengthen the physical landscape structures.





Urban sculpture took place in urban areas throughout history by visualizing the culture of the city and by adding new meanings to existing culture. The sculptures in the city experienced periods for different purposes and to response requirements. They have been as an integral element of the architecture and they overshadow everything around (Başer, 2006).

Artworks located in urban spaces reflecting the problems of society. They have mission transmission of the cultural heritage to the future. They are important for the city's environment and integration and make sense of the city and its environs unity. Outdoor sculptures plays major role in the formation of the contemporary environment as plastic elements (Güç, 2005). The statue placed in the center of the square has organized around the venue. This sculpture makes a strong environmental impact on the people to attract them to the place.

The examples are from Belgrade, Budapest, Florence, Ljubljana, Prague, Rome, Salzburg, San Marino, Skopje, Thessaloniki, Vatican, Venice, Zagreb.

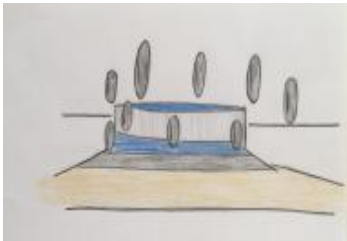
The water, statue and plant designs are shown in the Table 1 is below.

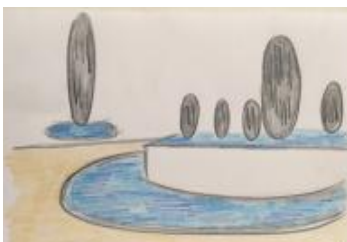
Table 1. The squares samples from different country

Samples	Samples
	
	
	

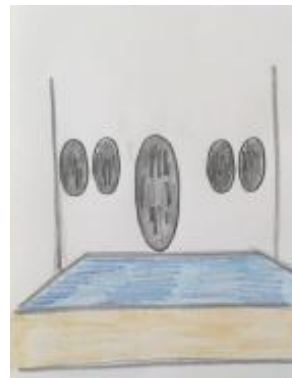
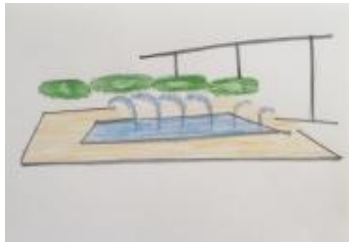

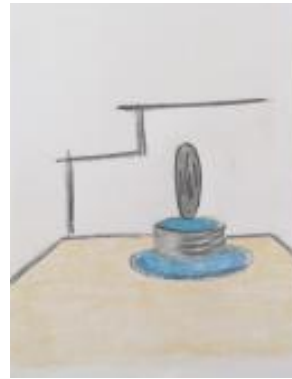
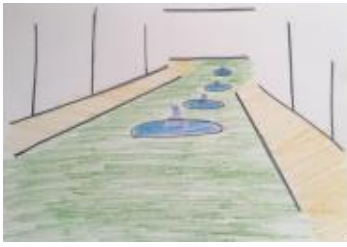

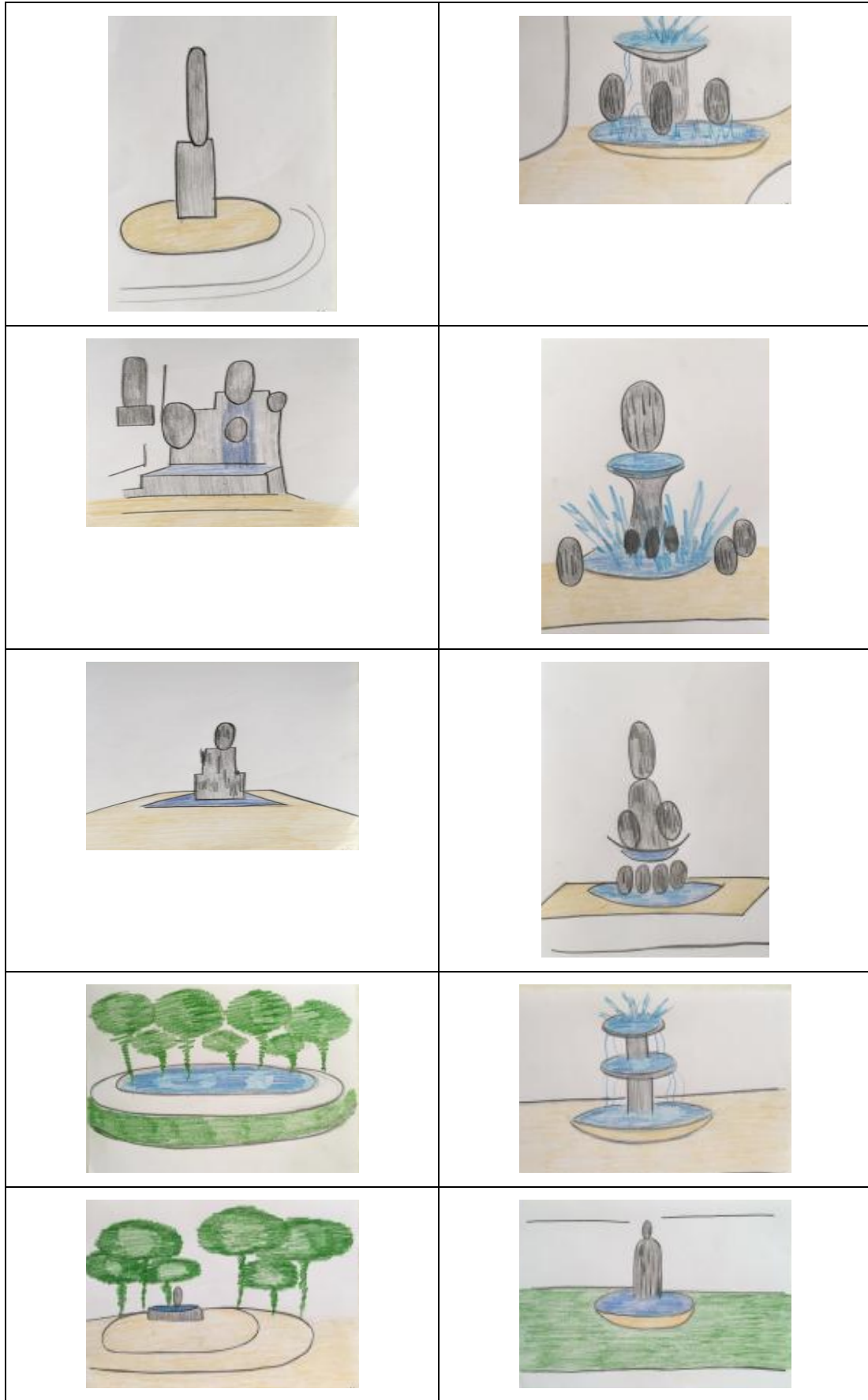

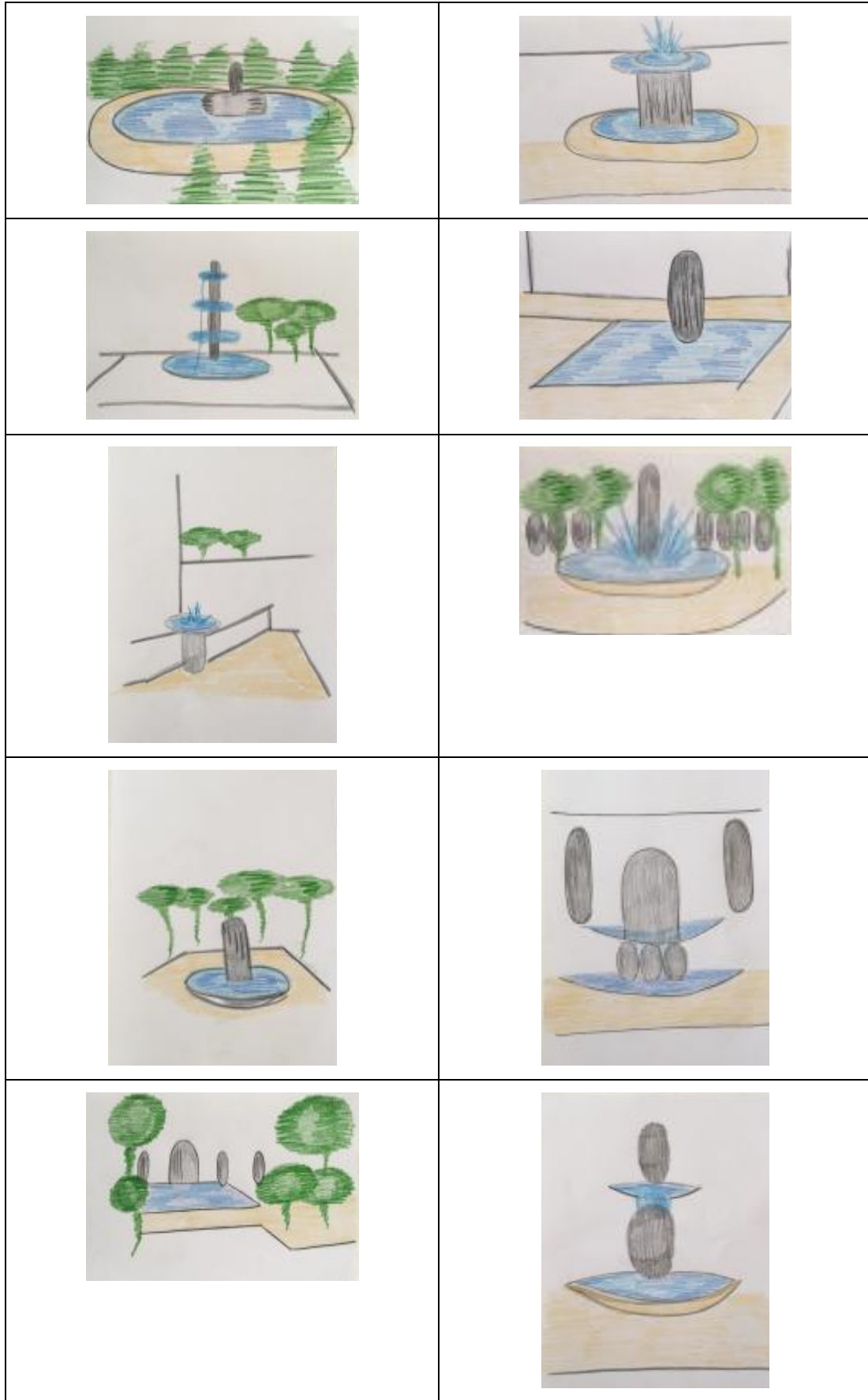

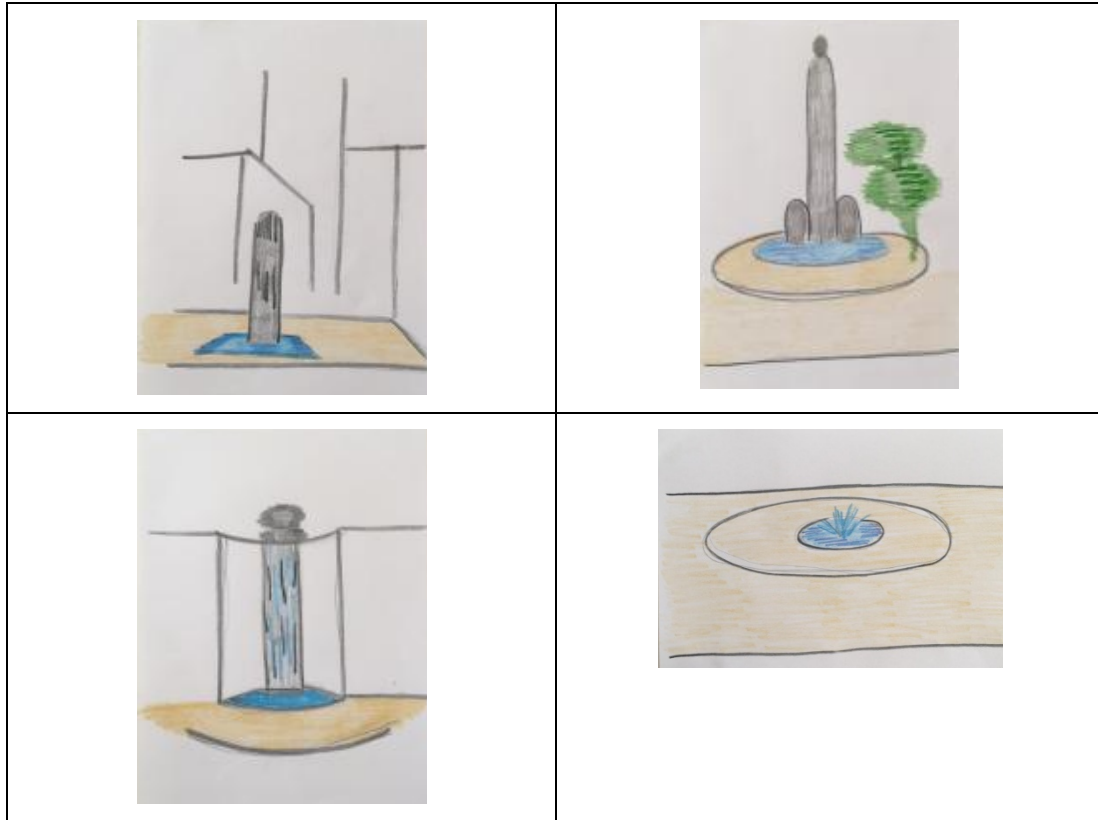

4. CONCLUSIONS AND RECOMMENDATIONS

The presence of water in square has been combined with aesthetic creatures. Squares have identities according to the socio-cultural structures of the area located in and they have become a landmark that reflects the city's culture and identity. Also in terms of interior design, with the value of the physical challenge, the nature of the constituent elements has played an important role in ensuring the active character in the space environment.

In the conclusion of the study it has seen that the facades of the buildings that make up square, structural and plant design, monumental elements and other landscape elements have been an important criterion in determining the formal qualifications. The most valuable contribution of the designer is creative ideas for the organization and use of the place. These are the technical perspective and design in the first stage of a project. Squares allow the development of urban culture with the functional and physical characteristics that occur in public space. When examined square in the context of the user a wide variety of people with different cultures and life style it is a quality venue and it gathers together.

A total of 46 case studies from 11 countries 14 cities were examined in the study. 22 samples of these have plant design. 45 samples are included in the pool. 13 fountain water features were used in the samples. 38 sculptural designs were located on the samples. 14 examples shaped of cascading pools design. The designs that combine water and sculptures have seen more interest by users. The conclusion has been reached thanks to the observations made in the field.

All samples have been positioned in relation to pedestrian spaces and visual richness have been created with water, sculpture and plant for people to watch the environment and to experience the space. 3 elements when used in this study (water, plants and sculptures) were found to be important elements in the square. These three elements have been remarkable for users from all walks.

REFERENCES

- [1] Aşıkođlu, G., 2000, *Hızla Deđişen Toplum Yapısı İinde Halk Meydanlarının Mekansal Analizi*, İzmir Yüksek Teknoloji Enstitüsü, Yüksek Lisans Tezi, İzmir
- [2] Başer, D., 2006, *Heykelin Kentsel Kamusal Mekana Etkisi: Heykel- Mekan İlişkisinin Kamusalılığı Üzerine Bir Araştırma*, Gazi Üniversitesi, Fen Bilimleri Enstitüsü, Yüksek Lisans Tezi, Ankara
- [3] Gençtürk, Z.İ., 2006. *Meydanlarda Su Öđesi Tasarımı: Sultan Ahmet Ve Beyazıt Meydanları İncelemesi*, İstanbul Teknik Üniversitesi, Fen Bilimleri Enstitüsü, Yüksek Lisans Tezi, İstanbul
- [4] Giritliođlu, C., 1991. *Şehirselsel Mekan Öđeleri ve Tasarımı*, İstanbul Teknik Üniversitesi Mimarlık Fakültesi Baskı Atölyesi, İstanbul 176 S.
- [5] Gü, M., 2005, *Aık Alan Heykellerinin Kent Estetiđine Katkısı*, ukurova Üniversitesi, Sosyal Bilimler Enstitüsü, Yüksek Lisans Tezi, Adana
- [6] İnceođlu, M., 2007. *Kentsel Aık Mekanların Kalite Aısından Deđerlendirilmesine Yönelik Bir Yaklaşım: İstanbul Meydanlarının İncelenmesi*, Yıldız Teknik Üniversitesi, Fen Bilimleri Enstitüsü, Doktora Tezi, İstanbul
- [7] Sertkaya, İ. 2011, *Kent Meydanları: Adana 5 Ocak Meydanı Örneđi Üzerine Bir İrdeleme*, ukurova Üniversitesi Fen Bilimleri Enstitüsü Yüksek Lisans Tezi
- [8] Adana, Sayfa: 129.Yazar, B.Ş., 2006. *İzmir Turan'da Bölgesiy*

Study of Rheological Behavior of Mineral Processing Tailings in Surface Paste Technology

Atac Bascetin,¹, Deniz Adiguzel¹, Orhan Ozdemir¹, Serkan Tuylu¹

Abstract

Paste Technology has some advantages comparing to other surface disposal methods. With this method, it is possible to pump high concentrated solid materials to very long distances without segregation problem. However, it is known from Literature that pumpability of materials is completely related to rheological properties of the materials. For this reason, in this study, the rheological parameters (e.g. yield stress and viscosity values) of the paste material prepared from Pb-Zn tailings at various solid ratios (60-85%) were obtained in order to determine the pumpability of the paste material. Additionally, slump tests, which are usually used in mining industry, was carried out. Finally, regression analysis was made between the slump values and rheological parameters of the paste material to find a correlation between two independent parameters. The results showed that there is a great correlation between the slump values and the yield stress of the material. On the other hand, there was no correlation with viscosity: $\tau_y = 430.28 - 16.877S_v$ ($R^2 = 0.94$; τ_y : Yield Stress (Pa), S_v : Slump Value (cm)). Based on the results obtained from this study, it can be clearly concluded that the slump values obtained from a simple test can be used to predict yield stress values of paste materials.

Keywords: Mine Tailing, Paste Technology, Environment, Rheology

1. INTRODUCTION

Recently, surface disposal of mining tailings has become one of the biggest problems in mining industry in terms of environmental issues. Therefore, several researches have been focused on this subject in order to find a best solution or method for this problem. These studies showed that paste technology has some advantages compared to other conventional methods. Tailings thickened to the extent show no segregation of particles during transportation, and relatively small amount of settling occur post-deposition which are often called "paste" [1]. Paste tailing technology has two applications in the industrial area as underground paste fill and surface paste disposal. Paste tailing technology was first started to be used in Grund mine, Germany in the late 1970s [2].

Process tailing material, water and - if needed - cement materials, which are the components of the paste, must be blended to obtain a homogenous mixture suitable for pumpability. Consistency behavior of the paste material is determined using a conventional sedimentation cone concrete test (slump). Meanwhile, the slump value of the paste must be between 200 and 250 mm for surface applications [3]. Additionally, in the case of underground paste system, the optimum slump value must be between 150 and 200 mm. On the other hand, the water content and density of paste at certain slump value change depending on the amount of fine particles in the tailing sample. While moisture of the material will be high, its density will be low because of surface area of particles which increases with decrease in particle size [4]. For pumpability of the paste to long distances, slump value of the paste must be good enough to be accepted for use of surface paste disposal. Paste material has a yield stress because they show non-Newtonian behavior and generally is classified as a Bingham plastic fluid. [5,6] In addition, the appropriate viscosity value of the paste along with the yield stress must be between 100 and 250 Pa [7,8,9].

In this study, the viscosity, yield stress, and slump values of the paste material at different pulp solid ratios (PSR) was determined in order to obtain the flow behavior of the sample. Rheology and slump tests, which are usually used in mining industry, were carried out. Additionally, regression analysis of the results was made between the slump values and rheological parameters of the paste material to find a correlation between two independent parameters.

2. MATERIALS

The tailing sample used in this study was obtained from a Pb-Zn underground mine located in the west of Turkey. The tailings produced in the end of flotation process are directly discharged into the tailings impoundment without going through any other process. The pulp solid ratio (PSR) of the tailings fed into the tailing impoundment was 20%. The characterization results for the sample are presented in Table 1-3.

¹ Corresponding author: Istanbul University, Department of Mining Engineering, 34310, Avcılar/Istanbul, Turkey.
atac@istanbul.edu.tr trdeniza@istanbul.edu.tr orhanozdemir@istanbul.edu.tr stuylu@istanbul.edu.tr

Table 1.. Mineralogical analysis of the tailings

Minerals
Calcite (CaCO ₃)
Quartz (SiO ₂)
Feldspar group of minerals (Albite= Na(AlSi ₃ O ₈))
Pyrite (FeS ₂)
Clay group of minerals
Mika group of minerals

Table 2.. Physical properties of tailings

Properties	Value
Density (g/cm ³)	3.084
Uniformity coefficient	15.02
Coefficient of gradation	1.2

Table 3.. Chemical analysis of the tailings

Element	Solid comp. (%)	Element	Solid comp. (%)
SiO ₂	36.19	K ₂ O	2.45
Al ₂ O ₃	8.08	TiO ₂	0.29
Fe ₂ O ₃	13.58	P ₂ O ₅	0.08
MgO	2.54	MnO	0.38
CaO	23.26	Cr ₂ O ₃	0.01
Na ₂ O	0.2		

As clearly seen from the results, the tailings mostly contain quartz, calcite, clay minerals, and pyrite. The particle size range of tailings was determined between 0.316 μm and 549.541 μm (Figure 1).

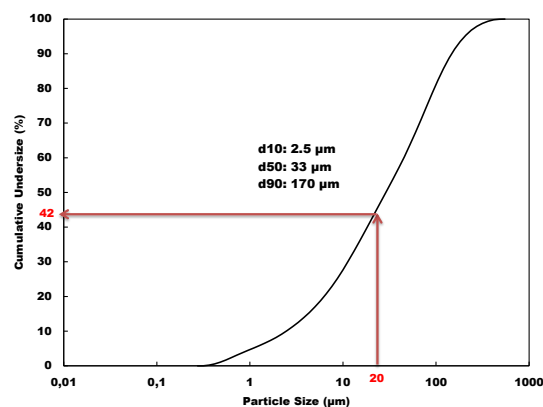

Figure 1. Particle size distribution of the sample

As known from literature, it is necessary to have at least 15% particles finer than 20 μm in order to form a flowable paste [10]. The sample meet this requirement with 42% of particles finer than 20 μm. Based on this result, the particle size distribution of the tailings can be classified as “multi-graded” [11].

3. METHODS

In paste technology, the pump is selected dependently on variables rheological characteristics of the paste material. Therefore the rheology of paste materials is very significant in both surface and underground implementation in respect of pumpability and fluidity of the material. In this context, paste materials were subjected to rheological tests using a rheometer device (Brookfield, USA) and slump tests in order to obtain the rheological parameters of the sample as a function of PSR. The rheology experiments for the mixtures were carried out at 60-80% PSR. The two types of vane spindles 20 and 40 mm in radius and 40 and 80 mm in length were used for the rheology tests. The measurements were carried out with this fixtures required a wide gap between the vane and cup at least twice the diameter of the vane [12]. The vane suddenly starts rotating at a various speed, and the resulting torque is measured as a function of shear rate. The torque was converted to shear stress using the formula (Equation 1) from Nguyen and Boger (1983). Additionally, the slump tests were performed according to ASTM C143.

$$\tau = T \times 2 / (\pi D^3) \times (H/D + 1/3)^{-1} \tag{1}$$

where T is the torque, D is the vane diameter, and H is the vane length.

4. RESULTS

The slump and yield stress values obtained from the result of rheology and slump tests as a function of PSR (60-85%) are shown in Figure 2.

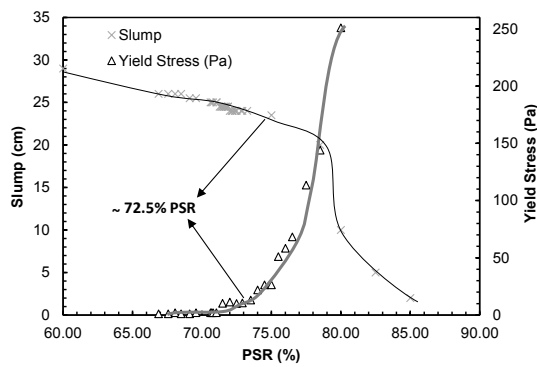

Figure 2. Slump and yield stress values at different PSR values

As seen from Figure 2, the slump value decreased and the yield stress value increased with the increase in PSR values. These results also showed that the slump and yield stress values increased abruptly after 72.5% of PSR value. This indicated that the critical PSR value for the paste material is 72.5%. It is also observable that the yield stress values changed depending on the slump values.

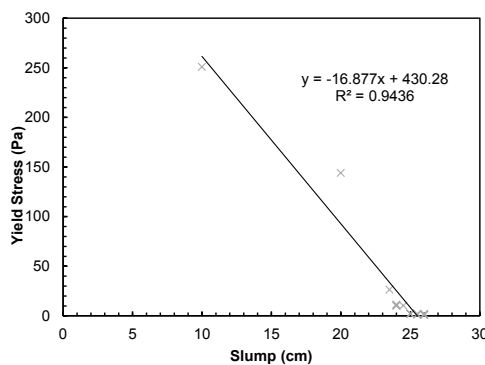

Figure 3. Relationship between yield stress and slump value

Regression analysis was performed between these values in order to determine the presence of a relationship between yield stress values and slump values, and an empirical approach that can be used in the estimation of yield stress (Figure 3). As shown in Figure 3, there is a strong relationship between yield stress and slump value ($R^2 = 0.94$). By the regression analysis performed within this study, the effect of the slump value of the material on the yield stress value was determined, and an empirical approach which gives the yield stress value of the material was developed using the slump value. This empirical approach is given in Equation 2, and variance analysis results are given in Table 4.

$$\tau_y = 430.28 - 16.877Sv \quad (2)$$

τ_y : Yield Stress (Pa), Sv : Slump Value (cm)

Table 4.. Analysis of variance

Source	DF	SS	MS	P
Regression	1	67355	67355	0
Residual Error	15	4023		
Total	16	71326		

The ANOVA for the response led to the results shown in Table 4. The ANOVA tested the adequacy of fit for the regression model. The model selected for the response variable was the linear model as a p-value (0) < 0.05 was obtained (Table 4).

During the rheology experiments conducted within this study, two types of vanes with different sizes were used, and the effect of the size of the vane on yield stress value was determined. Accordingly, the yield stress value was found to be slightly smaller in the experiments performed with vane in 40 mm in radius and 80 mm in length. The regression analysis performed between two different vanes and the yield stress values determined in this context are seen in Figure 4.

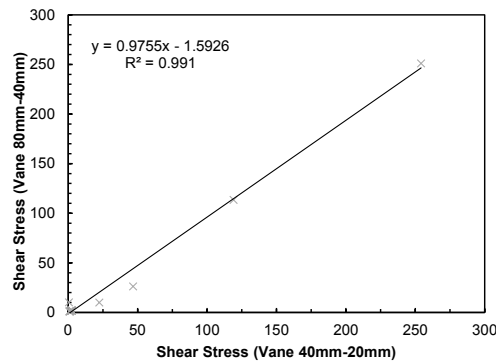

Figure 4. Relationship between two different types of vanes and the yield stress values determined

As can be seen in Figure 4, there is a strong relationship between two different vanes and the yield stress values determined ($R^2= 0.99$). The empirical approach showing the relationship between two different vanes and the yield stress values determined is given in Equation 3, and variance analysis results are given in Table 5.

$$\tau_y(80-40)=0.9755 \tau_y(40-20) -1.5926 \quad (3)$$

τ_y (80-40): Yield Stress (Pa) using vane in 40 mm in radius and 80 mm in length, τ_y (40-20): Yield Stress (Pa) using vane in 20 mm in radius and 40 mm in length

Table 5.. Analysis of variance

Source	DF	SS	MS	P
Regression	1	64068	64068	0
Residual Error	13	583		
Total	14	64631		

The ANOVA for the response led to the results shown in Table 5. The ANOVA tested the adequacy of fit for the regression model. The model selected for the response variable was the linear model as a p-value (0) < 0.05 was obtained (Table 5).

5. CONCLUSION

Appropriate pumping of the paste material in aboveground paste storage method is important in mining industry in terms of cost and material parameters. Pumping of the paste material mainly depends on the rheological and consistency properties of tailings. In this study, the rheological properties of the paste material were determined by the rheometer test, and the consistency properties were determined by the slump test. In addition, an empirical approach was developed for determining the yield stress values of the rheological properties of the paste material by using the slump test data which is a practical test method. Based on the results obtained from this study, it can be concluded that the yield stress value of the material can be estimated and used quickly in the design and control of the paste material by using the slump method which is quite easy to implement.

REFERENCES

- [1] S Cincilla, W.A., Landriault, D.A., Verburg, R., (1997), "Application of Paste Technology to Surface Disposal of Mineral Wastes". Proceedings of the Fourth International Conference on Tailings and Mine Waste 97. pp. 343-356.
- [2] Grice A., (1998), "Underground Mining With Backfill", The 2nd Annual Summit – Mine Tailings Disposal Systems, Brisbane.
- [3] Newman, P., Cadden, A., White, R., (2001), "Paste - The Future of Tailings Disposal? Securing the Future", International Conference on Mining and the Environment. June 25 - July 1, Skelleftea, Sweden, pp.594 – 603.
- [4] Meggyes, T. and Debreczeni, A., (2006), "Paste Technology for Tailings Management", Land Contamination & Reclamation, 14 (4), 2006 EPP Publications Ltd.
- [5] Cooke, R., (2008), "Pipeline Design for Paste and Thickened Tailings Systems", Tailings and Mine Waste 2008, ISBN 978-0-415-48634-7, pp. 95-100.
- [6] Theriault, J., Frostiak, J., Welch, D., (2003), "Surface Disposal of Paste Tailings at The Bulyanhulu Gold Mine", Proceedings of the 2nd Mining Environment Conference, Sudbury, Ontario, pp. 1-8.
- [7] "Bascetin A., Tuylu S., Adiguzel D., Akkaya U., Binen I.S., (2013), "Investigation of Suitability of Pb-Zn Mine Tailings For Surface Paste Disposal", 23rd World Mining Congress, Canada, 11-15 August 2013, pp. Paper 301.
- [8] Bascetin A., Tuylu S., Adiguzel D. and Akkaya, U.G., (2014), "The Study of Surface Paste Disposal Technology for Pb-Zn Mine Tailings", SME Annual Meeting, Preprint 14-020, Feb. 23 - 26, 2014, Salt Lake City, USA.
- [9] Bascetin A., Tuylu S., Adiguzel D. and Akkaya, U.G. (2015), "The Study of Optimum Tailing Storing Conditions for Surface Paste Disposal Method", SME Annual Meeting & Exhibit, Feb. 15-18, Denver, USA, 1-13.
- [10] Brackebusch, F.W., (1994), "Basics of Paste Backfill Systems", Mining Engineering, 46(10), pp. 1175-1178.
- [11] ISO 14688-2, (2004), Geotechnical Investigation and Testing -Identification and Classification of Soil - Part 2: Principles for a Classification.
- [12] Nguyen, Q.D., Boger, D.V., (1983), "Yield Stress Measurement for Concentrated Suspensions". J. Rheol., 27, pp.321–349.

Biogas Efficiency, Leachate Quality and Waste Stabilization in Anaerobic Landfill Bioreactors

Cevat Yaman¹, Yusuf Kucukaga¹, Abdurrahman Akyol¹, Serdar Karal

Abstract

Landfills cause various problems for local authorities, such as the contamination of soil and water with toxins, the formation of leachate and the release of landfill gases. More economical and applicable innovative methods will be an opportunity for local authorities. The two biggest problems that the local authorities face during operating of landfills are; cost of leachate treatment due to high energy consumption and the problems faced during biogas management. In this study, it is intended to improve the biogas efficiency, leachate quality and waste stabilization in landfilling. One reactor was constructed at 1 m height and 30 cm diameter to simulate anaerobic landfill bioreactor and leachate was recirculated to the waste body three times per week. Chemical oxygen demand (COD) and biological oxygen demand (BOD) in leachate samples, composition and amount of biogas, and waste settlements in the reactor were regularly monitored. After 180 days of anaerobic incubation, total produced biogas was 811 liters, waste settlement in the reactor was 7%, COD and BOD removal rates were 90% and 93%, respectively.

Keywords: Anaerobic Biodegradation, Landfill Bioreactor, Landfilling, Leachate Recirculation, Municipal Solid Waste.

1. INTRODUCTION

In a landfill site when the appropriate conditions for the growth of microorganisms occur, organic fraction of solid waste (OFSW) is broken down by time. Organic materials are converted to simpler compounds during this stabilization process by microorganisms, which leads to formation of leachate and biogas. However, it takes many years (5-20 years) to reach remarkable biogas productions and residual production may continue more than 40 years, because of uncontrolled physical, chemical, and biological processes [1]. In addition to this, the long term environmental impacts of municipal solid waste (MSW) in landfills may last for several centuries [2]. Landfills are common, economical and environmentally acceptable solid waste management method. However, conventional perspective to landfills has to be changed in a direction to more sustainable, environmental friendly, and economically profitable. Conventional landfill which is designed for storing solid wastes, can be considered as a 'bioreactor' by optimizing the stabilization process and creating the desired environment for microorganisms. It has been known that anaerobic bioreactor is the most common and economically preferable one. Anaerobic landfill bioreactor technology mainly aims; to increase biogas production, to treat leachate and decrease its amount, to gain new air spaces, and to provide sustainability [3].

In this study, one lab-scale landfill bioreactor were operated under anaerobic conditions to investigate the effect of leachate recirculation on; leachate quality, waste stabilization, and biogas production.

2. MATERIALS AND METHODS

In this study, a lab-scale PVC reactor at 1 m height and 30 cm diameter were used to simulate anaerobic landfill bioreactors. Reactor was equipped with several ports for collection and distribution of leachate and biogas. Reactor was filled with 30.8 kg of MSW which were taken from a compost recycling plant in Istanbul, Turkey where MSW are used for producing compost. Characterization and physical properties of the feed solid wastes are listed in Table 1.

¹ Corresponding author: Gebze Technical University, Department of Environmental Engineering, 41400, Gebze/Kocaeli, Turkey.
cevatyaman@yahoo.com

Table 2. Solid waste characterization and physical properties

Components	Value
Water Content	62%
Total Solids (TS)	38%
Volatile Solids (VS)	71%
Fixed Solids (FS)	29%
Food	62%
Paper	16%
Textile	3%
Glass	2%
Metal	1%
Plastic	8%
Stone	8%
Other	4%

After the reactors were filled with MSW, 1 L of anaerobic seed sludge was injected to the waste body. Reactor was located in a temperature controlled room and it was operated in mesophilic conditions (33-37 °C). At the first month of operation, 1.1 L distilled water was added every week by using a peristaltic pump to stimulate rainfall. In total 5.5 L of distilled water was injected to the reactor. After one month, when waste body was reached the field capacity, no more supplemental water was added. Leachate was recirculated three times per week during the study. The reactor used in this study is shown in Figure 1.



Figure 2. Anaerobic landfill bioreactor used in this study

Periodic leachate samples were taken and analyzed periodically for COD and BOD₅. COD and BOD₅ analysis were conducted according to standard methods (5520 C.) and OxiTop® method, respectively [4]. Collected biogas amounts were measured by liquid displacement method and composition of biogas were analyzed with OPTIMA 7 Biogas analyzer (MRU Instruments, Inc.). Waste settlement was observed via transparent window.

3. RESULTS AND DISCUSSION

3.1. Organic Constituents in Leachate

Organic constituents of leachate were monitored by measuring of COD and BOD₅, which are the main parameters that have been used to determine organic content of water samples in environmental sciences [4]. COD is one of the most important parameters for operation of landfill bioreactors, which is an indicator of chemically oxidizable organic load in leachate. Figure 1, illustrates the change of COD content throughout the study. COD values were between around 55000 – 63000 mg/L until 122nd day. Then, COD values were started to decrease. After methanogenic conditions were achieved in the reactor, COD values were sharply decreased as can be seen from the figure. Maximum and final COD contents were detected as 63040 mg/L and 6644 mg/L, respectively. That means, 90% of COD content in leachate was removed by leachate recirculated landfill bioreactor.

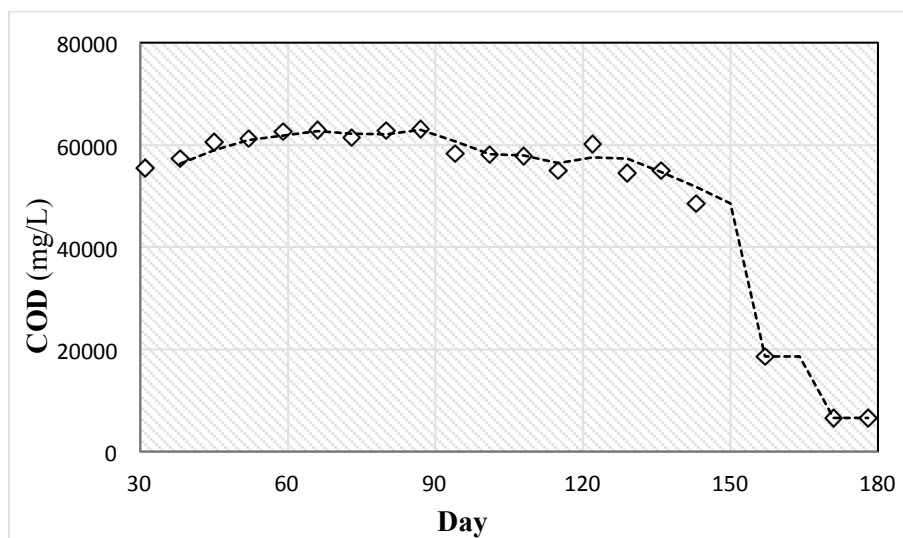

Figure 3. Leachate COD changes throughout the study.

BOD values represent the biodegradable fraction of organic matter in leachate. Figure 2, shows the change of BOD₅ content in the reactor. Maximum BOD₅ value was detected as 23500 mg/L at 94th day. BOD₅ were sharply decreased after 136th day and reached its minimum value; 1600 mg/L. In addition to this achieved very low BOD₅ content, it can also be highlighted that 93% of BOD₅ were anaerobically biodegraded in the reactor.

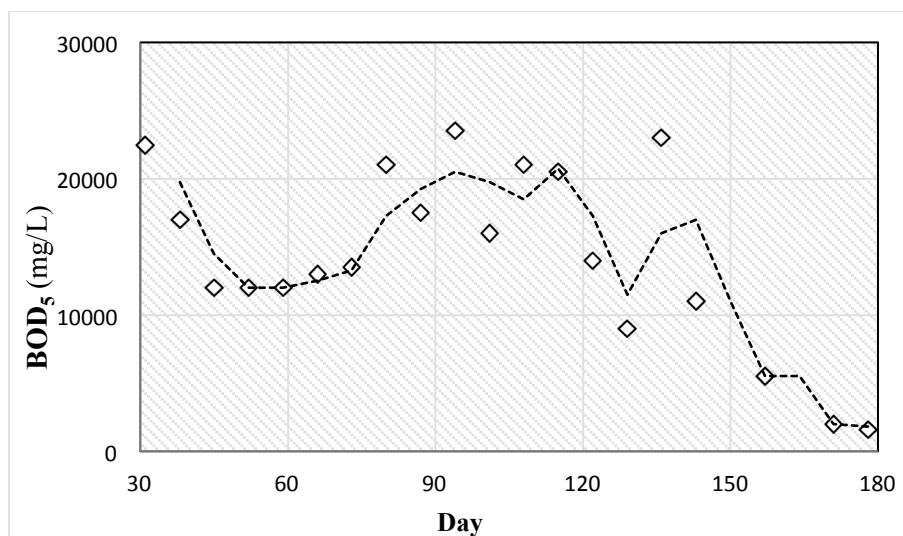

Figure 2. Leachate BOD₅ changes throughout the study.

Biodegradable organics in leachate are consumed by microorganisms more easily. BOD₅/COD ratio gives the proportion of biodegradable organic matters in leachate. Figure 3, shows the change of this ratio over time. Range of BOD₅/COD ratio was determined between 0.17 - 0.42.

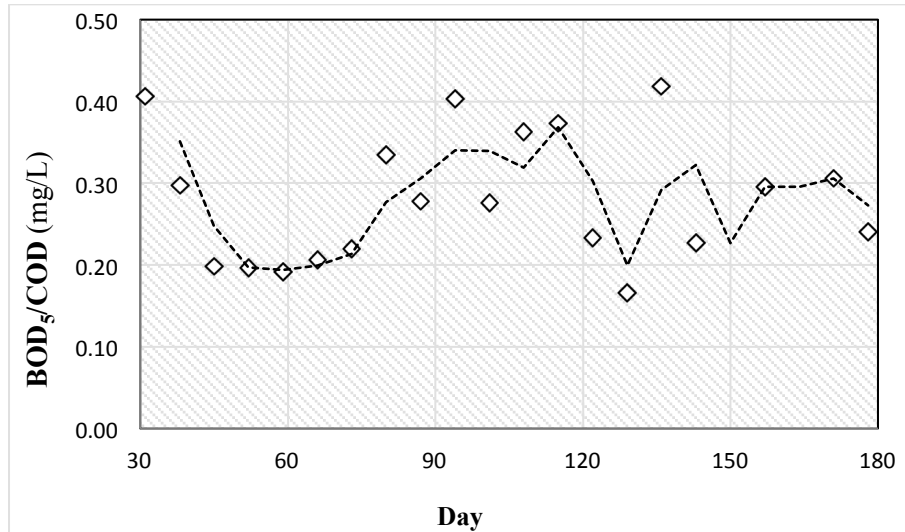

Figure 3. Change of BOD₅/COD ratio throughout the study.

3.2. Biogas Amount and Composition

Anaerobic landfill bioreactors produce biogas in considerable amounts as a result of anaerobic biodegradation of OFSW. In Figure 4, cumulative biogas amounts were given. During the first five months biogas production rate was relatively low. After that biogas production was sharply increased and reached 811 liters at the end of 180 days. Thus, it can be said that 112 liters biogas can be produced from one kilogram dry organic waste in leachate recirculated anaerobic reactor.

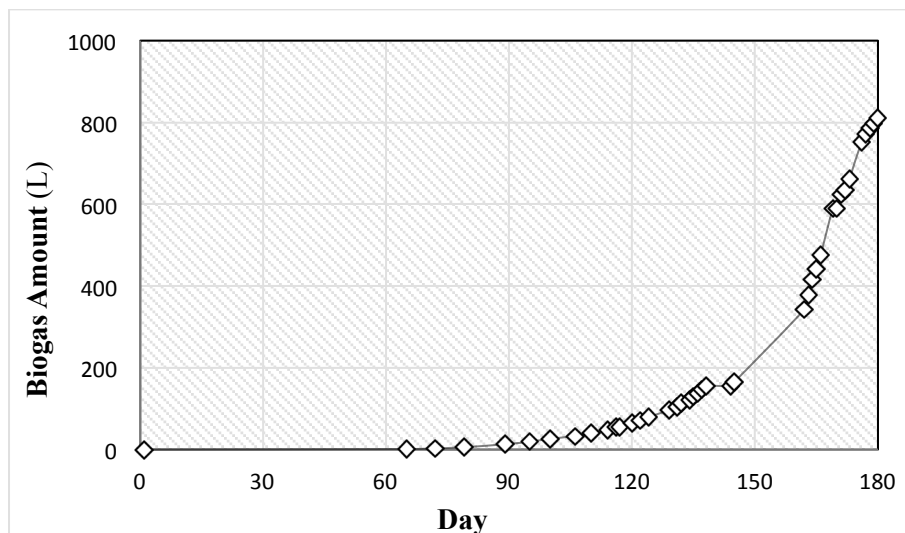

Figure 4. Cumulative biogas production of the reactor.

Landfill biogas content is an important parameter for determining the efficiency of the landfill bioreactor. Stabilized biogas have 45-65% methane and 35-55% carbon dioxide. Thus, it is known to be a good energy source by reason of its high methane content. Figure 5, illustrates methane (CH₄) and carbon dioxide (CO₂) contents of biogas. During the

adaptation phase, methane percentage was slowly increased. Whenever the system reached the methanogenic phase, methane contents were detected around 50%.

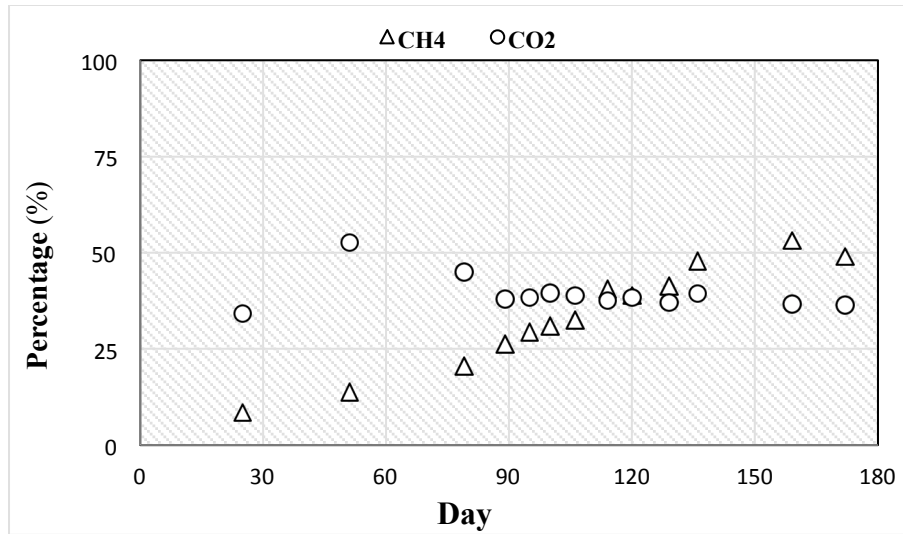

Figure 5. Biogas composition of the reactor.

3.3. Waste Settlement

Initial height of the waste body was 625 mm in the reactor. After 180 days of operation, waste was settled approximately 45 mm as a result of waste decomposition. Final waste height was measured as 580 mm which means that 7% new space was gained in the simulated landfill bioreactor.

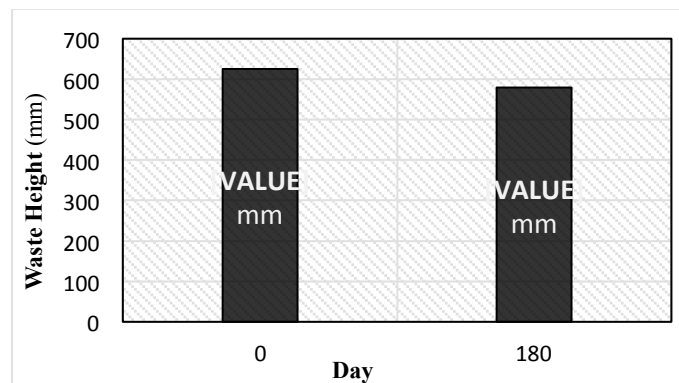

Figure 6. Waste height at the start-up and end.

4. CONCLUSIONS

This study showed that, operation of landfill bioreactor with leachate recirculation was enhanced the organic removal in leachate by 90% of COD removal. High organic removal provides much better leachate quality and this may be a high potential of energy saving in landfill sites because of reduced leachate treatment cost. Operation of landfill as a bioreactor with leachate recirculation not only provides in-situ leachate remediation, but also encourages waste decomposition. Due to better stabilization process, new spaces are provided for landfill operators. Produced biogas in landfill bioreactor with high methane content, can be considered as a beneficial outcome as well. Anaerobic landfill bioreactor with leachate recirculation, is found to be a very beneficial strategy in terms of both in-situ leachate remediation, waste stabilization and biogas production.

ACKNOWLEDGMENT

This study was financially supported by Gebze Technical University with Scientific Research Project (BAP#2015A24). Authors would like to appreciate Istanbul Environmental Management Industry Trade Co. (İSTAÇ) for providing the municipal solid wastes and also Istanbul Water and Sewerage Administration (İSKİ) for the seed sludge samples.

REFERENCES

- [1] J.M. Sufliya, C.P. Gerba, R.K. Ham, A.C. Palmisano, W.L. Rathje, J.A. Robinson, The world's largest landfill, *Environmental science & technology*, 26 (1992) 1486-1495.
- [2] Kruempelbeck, H. Ehrig, Long-term behaviour of municipal solid waste landfills in Germany, in: *Proceedings Sardinia, 1999*, pp. 27-36.
- [3] D.R. Reinhart, P.T. McCreanor, T. Townsend, The bioreactor landfill: its status and future, *Waste Management & Research*, 20 (2002) 172-186.
- [4] A.P.H. Association, A.W.W. Association, W.P.C. Federation, W.E. Federation, *Standard methods for the examination of water and wastewater*, 20 ed., American Public Health Association., 1915.

Potential Ecological Risk Assessment of Heavy Metal At Sediment

Arife Simsek¹, Gulfem Bakan¹

Abstract

Sediments have an important role as a habitat for aquatic organisms to grow, evolve and establish in the ecological system. Sediment contamination is one of indicators for the prediction of potential ecological risks in aquatic systems. Heavy metals are among the most persistent of pollutants in the ecosystem such as water, sediments and biota because of their resistance to decomposition in natural condition. Toxicity appears after exceeding level of indispensability. Heavy metals become toxic when they are not metabolized by the body and accumulate in the soft tissues. Metals have low solubility in water, get adsorbed and accumulated on bottom sediments. Spreading heavy metals in the water column may subsequently be accumulated in sediment because of low solubility then become sensitivity indicator for aquatic organism. Ecological risk is assessed through the heavy metals concentration in the sediment. This research was undertaken in order to determine and analyze various heavy metals present in sediments taken from mid-Black Sea coast. Five heavy metals: cadmium (Cd), chromium (Cr), copper (Cu), lead (Pb), and zinc (Zn) were determined by Perkin Elmer Optima 4300DV Inductively Coupled Plasma Optical Emission Spectrometer (ICP-OES). Potential ecological risk indexes (Er) were used to study the pollution status of heavy metals in sediments and assess their potential ecological risk to the environment. Considering the potential ecological risk coefficient (Er) results calculated in accordance with the highest result metals Cr 0.068, Cu 0.122, Zn 0.0146, Cd 138.45, Pb 0.037. According to this four heavy metals (Cr, Cu, Zn, Pb) under investigation in sediments reflected a low ecological risk to mid-Black Sea coast, but for Cd considerable ecological risk for the water body. The cause of pollution in mid-Black Sea could be associated with industrial and human activities. Strategies will be proposed that can be applied in order to prevent accumulation of heavy metals.

Key words: Ecological risk assessment, heavy metals, sediment.

1. INTRODUCTION

The Black Sea, a semi-enclosed sea, is situated between 40°55' to 46°32' N and 27°27' to 41°32' E. The Black Sea is surrounded by six countries located in Europe and Asia: Bulgaria, Georgia, and Romania; Russia, Turkey and Ukraine. In fact, the Black Sea is influenced by seventeen countries, thirteen capital cities and some 160 million people [2]. The Black Sea is located between the European and Asian continents, and is connected to the Mediterranean Sea through the Sea of Marmara (Figure 1).

The Black Sea environment has suffered a catastrophic degradation from the waterborne waste from 17 countries. The objectives of this study were determined average concentrations of five heavy metals (Cu, Pb, Cd, Cr, Zn), in sediments of the mid-Black Sea coast of Turkey [1].



Figure 1. The Black Sea and its drainage basin

¹Corresponding author: Ondokuz Mayıs University, Engineering Faculty, Environmental Engineering Department, 55139 Samsun, Turkey. arife.simsek@omu.edu.tr

Sediments have a great importance for aquatic organisms growing and developing in ecological system. Studies on heavy metals in sediments are vital in order to understand their impact on water ecosystems. The heavy metals pose a risk to the sustainability of natural ecosystems and human communities. Heavy metals are usually present at low concentrations in aquatic environments, but deposits of anthropogenic origin have raised their concentrations, causing environmental problems in water body.

Water bodies like lakes, streams, rivers and marine provide so much in the way of recreation, including fishing, boating, and swimming. They form a natural habitat for aquatic animals, hence the significance for the decontamination of the information on concentration of heavy metals and their potential ecological risk. For the assessment of heavy-metals risk developed a variety of methods, including:

1. Sediments enrichment factor
2. Index of geological accumulation
3. Pollution load index
4. Potential ecological risk index
5. Nemerow synthetical pollution index
6. Integrated pollution index
7. Secondary phase enrichment factor [8] .

In this study the potential ecological risk index method were used to determine the pollution status of heavy metals in sediments at the mid-Black Sea coast of Turkey.

2. MATERIALS AND METHODS

Sea water samples were collected from 4 stations at 3 miles and 20 miles openness from the coast during the spring season at 2014 . The area is bound by the latitude 40° 59'30 N and 42° 22' 12 N and longitude 35° 11' 23 E and 37° 54' 15 E. Sampling points are shown in figure 2. The coordinates of the samples collected at four points shown in Table 1.

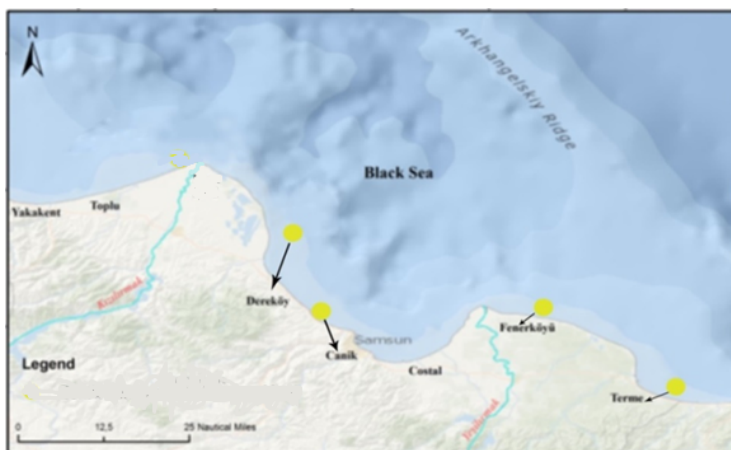

Figure 2. Mid-Black Sea Coast sampling points.

Table 1 . The coordinates of the sediment samples taken from the Mid-Black Sea coast of Turkey

Station	Sampling Points	Coordinates (N-E)
M1	Terme	41.13.397 37.07.776

M2	Fenerköy	41.23.768 36.48.130
M3	Canik	41.23.104 36.17.294
M4	Dereköy	41.34.467 36.12.547

Samples were transferred to the laboratory in refrigerants bearing ice to reducing the degradation of samples before analysis. Wet sediments were dried at 103 °C. After drying to below 63 µm remaining marine sediment samples were digested by adding 1 ml HClO₄ % 65, 6 ml HNO₃ % 65, 1 ml H₂O₂ % 30 at the Milestone Stard D Digestion System. Digested samples were analyzed at Perkin Elmer Optima 4300DV Inductively Coupled Plasma Optical Emission Spectrometer (ICP-OES) for concentrations of the metals Cr, Cd, Cu, Zn and Pb

2.1. Ecological Risk Assessment

2.1.1. Accumulating status of heavy metals

In this study Accumulating coefficients of heavy metals in sediments collected from the four different locations in mid-Black Sea Coast of Turkey were calculated and applied to show the accumulating status of heavy metal in the sediments from each sampling location. The calculating equation for accumulating coefficient (C_f^i) is as follows:

$$C_f^i = C_m^i / C_n^i \quad (1)$$

In this equation used to calculate; C_m^i is the value of heavy-metal concentration in the sediment samples, and C_n^i is the reference values (pre-industrial background) mg/kg. Pre-industrial background values (Pb 70.00 mg/kg, Cd 1.00 mg/kg, Cu 50.00 mg/kg, Zn 175.00 mg/kg, and Cr 90 mg/kg) were applied for the calculations of C_f^i , since they have been most commonly used in this field of study [3,4,5,7,9,10,11].

2.1.2. Heavy-Metal Potential Ecological Risk

The potential ecological risk index method developed by Hakanson was applied in this study. According to this method, the potential ecological risk coefficient (E_r^i) of a single factor and the potential ecological risk index (R_i) of multi-factor can be calculated over the following equations:

$$E_r^i = T_f^i \times C_f^i \quad (2)$$

$$R_i = \sum_{i=1}^n E_r^i \quad (3)$$

In these equations: C_f^i is the accumulating coefficient for the element of 'i' and T_f^i is the toxic-response factor for the element of 'i', reflects its toxicity levels and the sensitivity of bio-organism to it. The toxic-response factors for common heavy metals Pb, Cd, Cu, Cr and Zn were 5, 30, 5, 2 and 1, respectively [6].

3. RESULTS AND DISCUSSION

In this study investigated the potential ecological risk at the sediment, in the mid-Black Sea coastline. Heavy metal concentrations measured at four different stations are given in Table 2.

According to the calculated accumulating coefficients (Table 3), Cadmium was the main heavy metal polluting and its C_f^i mean value was 3.293 .

Table 2. Heavy metal concentrations in sediments collected from the mid-Black Sea coast of Turkey

Station	Cr(mg/kg)	Cu (mg/kg)	Zn(mg/kg)	Cd(mg/kg)	Pb (mg/kg)
M1	2.052	0.560	1.148	2.72	0.092
M2	1.764	0.648	1.176	2.56	0.100
M3	2.292	0.516	1.288	3.28	0.076
M4	3.060	1.220	2.560	4.62	0.528

The results is given figure 3, all trace metal concentrations are high at M4 station.

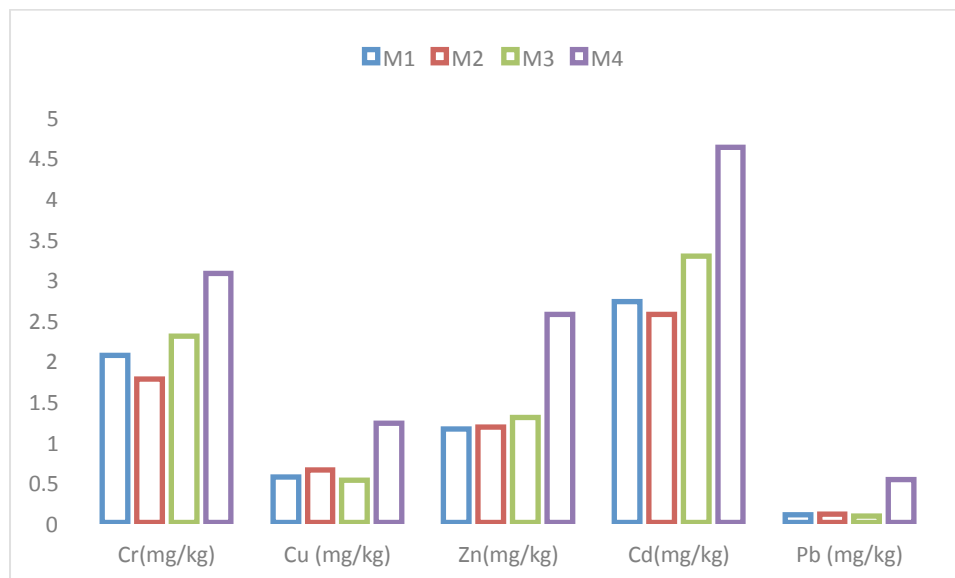

Figure 3. Schematic representation of the heavy metal concentrations in sediments collected from the mid-Black Sea coast of Turkey.

According to the calculated accumulating coefficients (Table 4), Cadmium was the main heavy metal polluting and its E_r^i mean value was 98.812.

Table 3. C_f^i of heavy-metal in sediments from the mid-Black Sea coast of Turkey.

C_f^i					
Station	Cr	Cu	Zn	Cd	Pb
M1	0.0228	0.0112	0.0065	2.720	0.0013
M2	0.0196	0.0129	0.0067	2.560	0.0001
M3	0.0254	0.0103	0.0073	3.280	0.0010
M4	0.0340	0.0244	0.0146	4.615	0.0075
Mean	0.0254	0.0147	0.0087	3.293	0.0024

Table 4. E_r^i and R_i of heavy-metal in sediments from from the mid-Black Sea coast of Turkey.

E_r^i						R_i
Station	Cr	Cu	Zn	Cd	Pb	
M1	0.0456	0.0560	0.0065	81.60	0.0065	81.715
M2	0.0392	0.0645	0.0067	76.80	0.0005	76.911
M3	0.0508	0.0515	0.0073	98.40	0.0050	98.515
M4	0.0680	0.1220	0.0146	138.45	0.0375	138.69

Mean	0.0509	0.0735	0.0087	98.812	0.0123	98.957
------	--------	--------	--------	--------	--------	--------

Table 5 is the criteria for degrees of the ecological risk caused by heavy metals in sediments [4].

E_r^i or R_i	Ecological pollution degree
$E_r^i < 40$ or $R_i < 80$	Low ecological risk for the water body
$40 < E_r^i < 80$ or $150 \leq R_i < 300$	Moderate ecological risk for the water body
$80 \leq E_r^i < 160$ or $300 \leq R_i < 600$	Considerable ecological risk for the water body
$160 \leq E_r^i < 320$ or $R_i > 600$	Very high ecological risk for the water body

When viewed in table 5, except for cadmium other four heavy metals have low ecological risk for the water body. But cadmium has considerable ecological risk for the water body. According to table 4 the potential ecological risk coefficient were found in the following order $Cd > Cu > Cr > Pb > Zn$ and sediment sampling points ; $M4 > M3 > M2 > M1$ when assessing the ecological risk index results.

4. CONCLUSION

Heavy metal pollution in the Black Sea has attracted considerable research attention since last 20 years. Sources of heavy metals in the Black Sea environment can be mainly attributed to terrestrially derived wastewater discharges, agricultural and industrial run-off, river run-off atmospheric deposition of combustion residues, and shipping activities. It is clear from many studies conducted that the heavy metal pollution should be taken into account in the Black Sea. The results of sediment samples taken from four locations showed that the sea has been slightly contaminated by heavy metals and its pollution can be attributed to human activities near and in the sea, as well as industrial pollution inputs. These observations suggest that sewage disposal facility by residential complexes are efficient, adequate, and being satisfactorily operated. Potential reduction of industrial pollution input can be accomplished by meeting the wastewater discharge criteria. Elimination of potential future sources of pollution will help maintain good water quality in mid-Black Sea.

REFERENCES

- [1] Bakan, G., Ariman, S., Cüce, H., Ozbayrak, E., Buyukgungor, H., 2007. Heavy Metal Assessment in Sediments and Water from the Turkey Black Sea Coast". 4th Black Sea Basin Conference on Analytical Chemistry, Sunny Beach, BULGARIA, paper 19-23, Sep.2007.
- [2] Bakan, G. and Buyukgungor, H. The Black Sea. Marine Pollution Bulletin 41, 24-43, 2000.
- [3] Caeiro S, Costa MH, Ramos TB, Fernandes F, Silveira N, Coimbra A, Medeiros G, Painho M., "Assessing heavy metal contamination in Sado Estuary sediment: An index analysis approach". *Ecolog Indicators*. 5:151-169, 2005.
- [4] Chen JS, Zhou JY. "Research of heavy metals in Chinese water environmental". Beijing: Press of Chinese Environmental Science. p. 168-170, 1992.
- [5] Hakanson L., "An ecological risk index for aquatic pollution control – a sedimentological approach". *Water Res.* 14(2):975-986, 1980.
- [6] Huang, X., Hu, J., Li, C., Deng, J., Long, J., Qin, F., "Heavy-metal pollution and potential ecological risk assessment of sediments from Baihua Lake, Guizhou, P.R. China", *International Journal of Environmental Health Research* Vol. 19, No. 6, 405-419, December 2009.
- [7] Li LF, Zeng XB, Li GX, Mei XR. "Heavy metal pollution of Wenyu River sediment and its risk assessment". *Acta Sci Circumst.* 27(2):289-297, 2007.
- [8] Ntakirutimana, T., Du G., Guo, J.S., Huang, L. "Pollution and Potential Ecological Risk Assessment of Heavy Metals in a Lake", *Pol. J. Environ. Stud.* Vol. 22, No. 4, 1129-1134, Feb. 2013.
- [9] Qiu YW, Zhu LS. "Heavy metals pollution and their potential ecological risk in the sediment of Hailing Bay". *Marine Environ Sci.* 23(1):22-24, 2004.

- [10] Yan W, Chi JS, Gu SC, Tang XZ, Chen Z. "Characteristics and prevention countermeasures of heavy metal pollution of soils (sediments) in industrial areas of the Pearl River Delta – two case studies of Shilong and Ronggui industrial areas". *Soil Environ Sci.* 9(3):177–182 ,2000.
- [11] Zhang LX, Jiang XS, Zhao M, Li ZE. "Pollution of surface sediments and its assessment of potential ecological risk in the Yangtze Estuary". *Ecol Environ.* 16(2):389–393 ,2007.

BIOGRAPHY

Arife Simsek was born in Tokat, Turkey in 1985. She completed his secondary education in Samsun Anatolian high schools. She is a graduate of the Ondokuz Mayıs University of Environmental Engineering department in 2008. She has completed a master's degree at the same university and continues PhD, as research assistant.

Short-term Effect of Nanoparticles ZnO and TiO₂ on *Daphnia magna*

Didem Gokce¹

Abstract

It is estimated that among inorganic nanomaterials the highest production is characteristic of npZnO and npTiO₂. The growing scale of production of NPs involves the risk of their release into the environment. As primary consumers, zooplankton plays a key role in aquatic ecosystems. *D. magna*, being sensitive to pollutants, are excellent aquatic models and being commonly widespread in lakes is easy to culture.

Acute assays were performed 50 mL of test solutions. Randomly six individuals were divided per groups of npTiO₂ (0.1, 1, 5, 10 and 50 mgL⁻¹), npZnO (0.1, 1, 5, 10 and 50 mgL⁻¹), cocktail concentration (25 mL of 0.1, 1, 5, 10 and 50 mgL⁻¹ npTiO₂ and same volume and same concentration of npZnO in glass beakers) and control. Three replicates experiments were performed for each concentration and control groups. *D. magna* neonates (< 24 h-old) were not fed for the duration of the acute experiments. Survivorship (lx) data were evaluated between different groups of npTiO₂, npZnO and cocktail.

The aim of this study is to present the current state of knowledge regarding the effects of nanoparticle on life parameters of the freshwater crustaceans, *D. magna*. The differences between npTiO₂ and npZnO concentrations and survivorship rate of *D. magna* were evaluating using Tukey's test.

Consequently, as npTiO₂, npZnO and mixture concentration increased, mortality rates were increased. Only, individuals in control and 0.1 groups lived end of the 96^h. These effects on its own were produced a reduction in population growth rate during short-term.

Keywords: acute, *Daphnia magna*, nanoparticle, titanium dioxide, tolerance, zinc oxide

1. INTRODUCTION

It is estimated that among inorganic nanomaterials the highest production is characteristic of nanoparticle-ZnO (npZnO) and nanoparticle TiO₂ (npTiO₂). These nanoparticles are widely used in the consumer products (sunscreen products, textiles, paints, coatings and antibacterial agents) which need the detailed assessment of their potential toxicity to different organisms. The growing scale of production of NPs involves the risk of their release into the environment [1], [2]. It is estimated that worldwide production of npTiO₂ will reach 2.5 million tons by 2025 [3].

npTiO₂ and npZnO, on entering the aquatic environment, release free metal ions in solution state. The dissolution speed of the particles mainly depends on the particle size, surface area, and rough degree. npTiO₂ and npZnO are slightly soluble; npZnO and can release zinc ions into the solution [4].

As primary consumers, zooplankton plays a key role in aquatic ecosystems. Cladocerans, being sensitive to pollutants, are excellent aquatic models and being widely prevalent in lakes and seas is easy to culture and continuous reproduction. *D. magna* is at the base of the food chain in aquatic ecosystems, studying the relationship between the accumulation and the transportation of NPs within this model organism and its acute toxicity will offer important insights into the broad impact of NPs in aquatic environments.

The evaluation of nanoparticle effects upon freshwater daphnids is a necessary step to predict their potential impact on freshwater food webs and on the whole ecosystems they support.

The aim of this study was therefore to quantify the uptake and toxicity of npTiO₂ and npZnO in an ecologically important freshwater zooplankton, *D. magna*. With widespread applications and usages of npTiO₂ and npZnO will inevitably find its way to the aquatic systems. Thus it is essential to examine the harm they could potentially inflict on aquatic organisms.

¹ Corresponding author: Inonu University, Department of Biology, Limnology Research Laboratory, 44280, Campus/Malatya, Turkey. didem.gokce@inonu.edu.tr

2. MATERIALS AND METHODS

2.1. Laboratory Condition and *D. magna*

Daphnia magna colonies for acute experiments of nanoparticles (TiO₂ and ZnO) were obtained *D. magna* culture for 6 years in the Plankton Culture- Limnology Research Laboratory (Inonu University, Hydrobiology Section). The temperature is more important in regulating factor for growth. Laboratory condition is 24 ± 1 °C and 16: 8 h photoperiod. pH of test solutions has range 8.0-8.2. The culture of *D. magna* is fed on a few drops of a suspension of fresh yeast and soy bean flour.

2.2. Short-term, Acute Assay

Acute assays were performed 50 mL of test solutions. Randomly six individuals were divided per groups of npTiO₂ (0.1, 1, 5, 10 and 50 mgL⁻¹), npZnO (0.1, 1, 5, 10 and 50 mgL⁻¹), cocktail concentration (25 ml of 0.1, 1, 5, 10 and 50 mgL⁻¹ npTiO₂ and same volume and same concentration of npZnO in borosilicate glass beakers) and control (Figure 1).

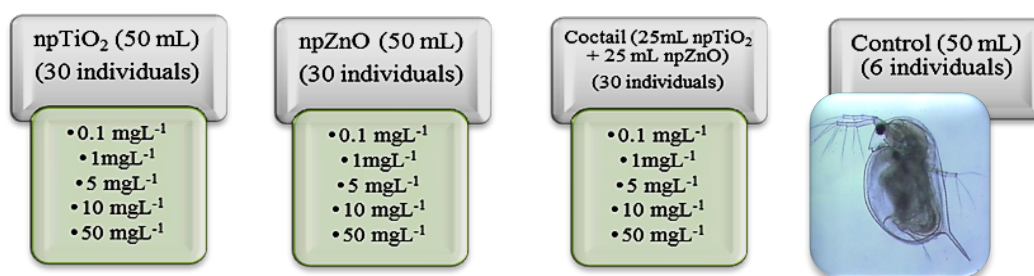

Figure 1. Totally 96 *D. magna* individuals were used test organism in npTiO₂, npZnO and cocktail concentration (magnification, 40x; photo: D. Gökçe).

Three replicates experiments were performed for each concentration and control groups. Totally 96 individuals of *D. magna* were used test organisms for acute assays. *D. magna* neonates (< 24 h-old) were not fed for the duration of the acute experiments.

The developmental status of neonates was observed at specified time points (24, 48, 72 and 96 h). Survival rates (percentages) were determined from the total numbers of living individuals. Morphological changes were observed using a stereomicroscope (Leica MZ 7.5 with DFC 280 camera attachment- Leica Applications Suite software, Version 2.4.0R1) every 24 h.

Survivorship (lx) data were evaluated between different groups of cocktail, npTiO₂ and npZnO. During acute assay, different npTiO₂ and npZnO solutions were homogenised by 30 min of ultra-sonication due to agglomeration. Experimental media solutions were changed as aerated with an air pump and new fresh medium was prepared every day.

2.3. Data

All experiments were repeated three times independently, and data were recorded as the mean with standard deviation (SD). Survivorship rate (lx) was estimated for each concentration groups.

The differences between nanoparticle concentrations and survivorship rate were evaluating using Tukey's test followed by Pos Hoc comparison (ANOVA) [5]. The LC₅₀ values and their 95% confidence intervals were determined with Probit analysis [6]. SPSS 15.0 software program was used to conduct all statistical analyses.

3. RESULTS and DISCUSSION

3.1. Survivorship Rates

Among metal oxide nanomaterials, npTiO₂ and npZnO have high chemical stability and strong adsorption ability and extensively use in commercial products like sunscreens, coatings, and paints. Furthermore ZnO has a high risk of water contamination, and can reach high concentrations in surface waters and significant threat to aquatic ecosystems [4].

As demonstrated at Figure 2, mortality appeared in increasing npTiO₂ concentrations. The survival rate reduced for 0.1 mgL⁻¹, 1.0 mgL⁻¹, 5 mgL⁻¹, 10 mgL⁻¹ and 50 mgL⁻¹ npTiO₂ concentrations (r²=0.93, 80%; r²=0.98, 70%; 60%; 50%; 50% and 40% respectively, Figure 2). According to LC₅₀ value, *D. magna* sensitivity was determined the 96 h-LC₅₀ (1.8 mgL⁻¹ npTiO₂; 95% confidence intervals).

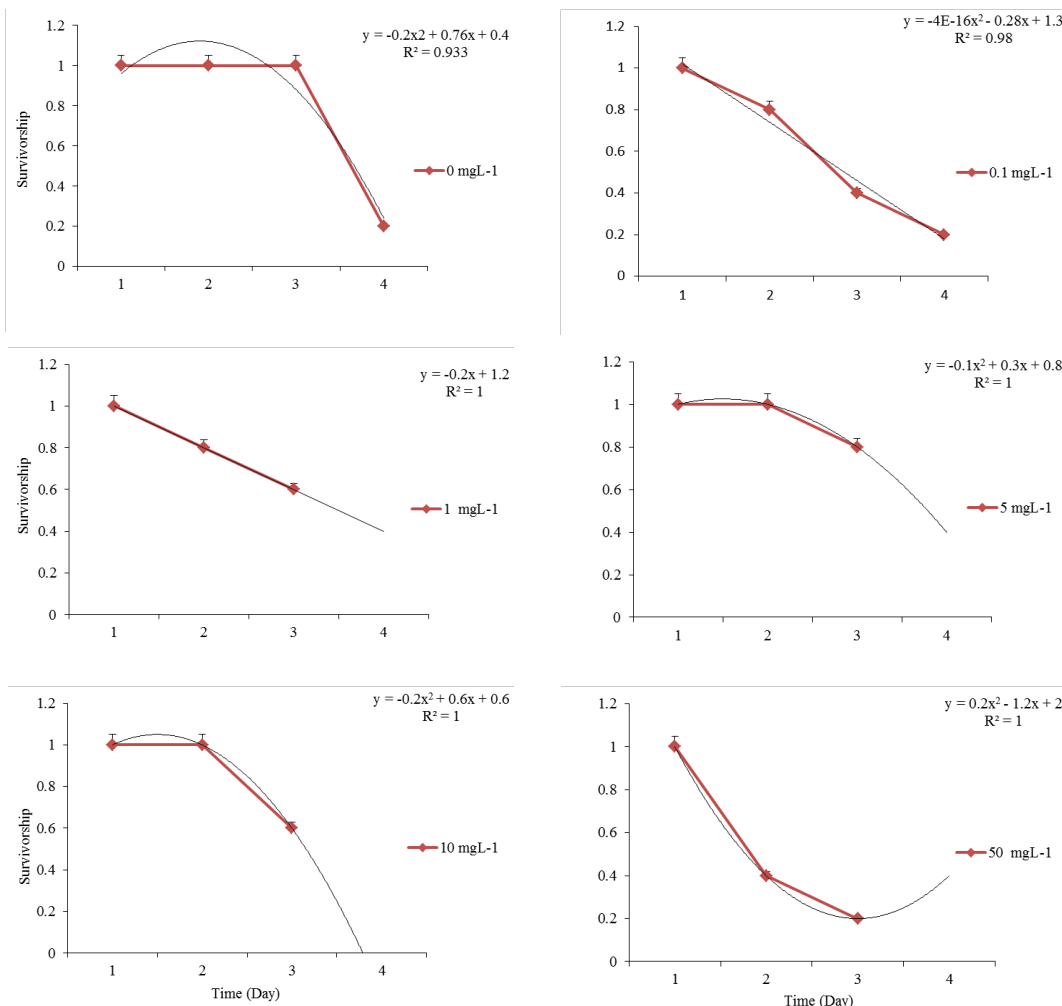

Figure 2. Survivorship curves of *D. magna* under different npTiO₂ concentrations (with regression equations) in acute 96h experiments (n = 6; ± Standard error; P < 0.05)

The solubility of nanoparticles is crucial to the toxicity of npTiO₂ and npZnO and to their impacts on ecosystems. It has been suggested that their high stability may allow npTiO₂ and npZnO to permeate, accumulate and persist within organisms [7]. It is observed that the accumulation of npTiO₂ and npZnO applied in different concentration in especially digestive system and carapace during infiltration and feeding at different exposure time (Figure 3).

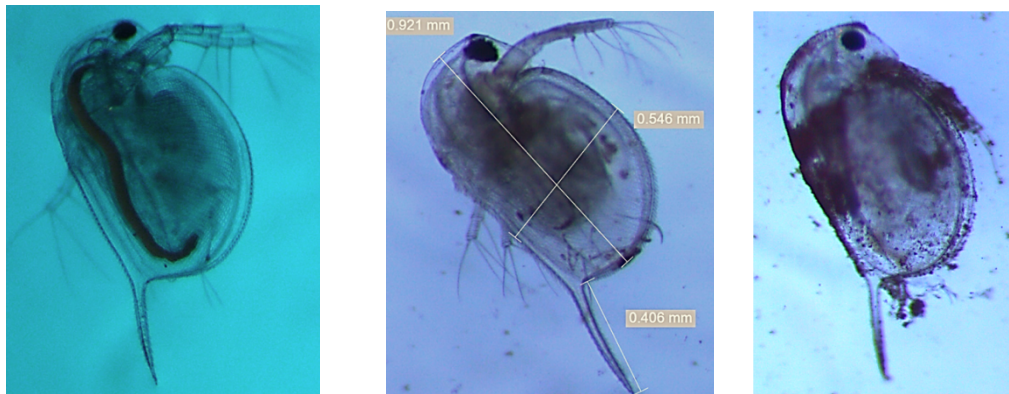

Figure 3. *D. magna*, a) exposed to 10 mgL^{-1} npTiO_2 , 48h, the digestive system- gut was clearly see; b) exposed to 50 mgL^{-1} npZnO , 48h; c) exposed to 50 mgL^{-1} np cocktail concentration, 48h; (magnification 50x; photo: D. Gökçe).

It reported that the toxicity of npZnO to zebra fish [8] was also much higher than that of npTiO_2 [4]. According to [7] npZnO are easily bioaccumulated by aquatic organisms, wherein they elicit toxic effects (Figure 3b, c). In this study, it seems that npZnO toxicity was more effected *D. magna* than npTiO_2 toxicity due to LC_{50} . Toxicity of npZnO to *D. magna* revealed 96h- LC_{50} value of 0.7 mgL^{-1} (95% confidence intervals).

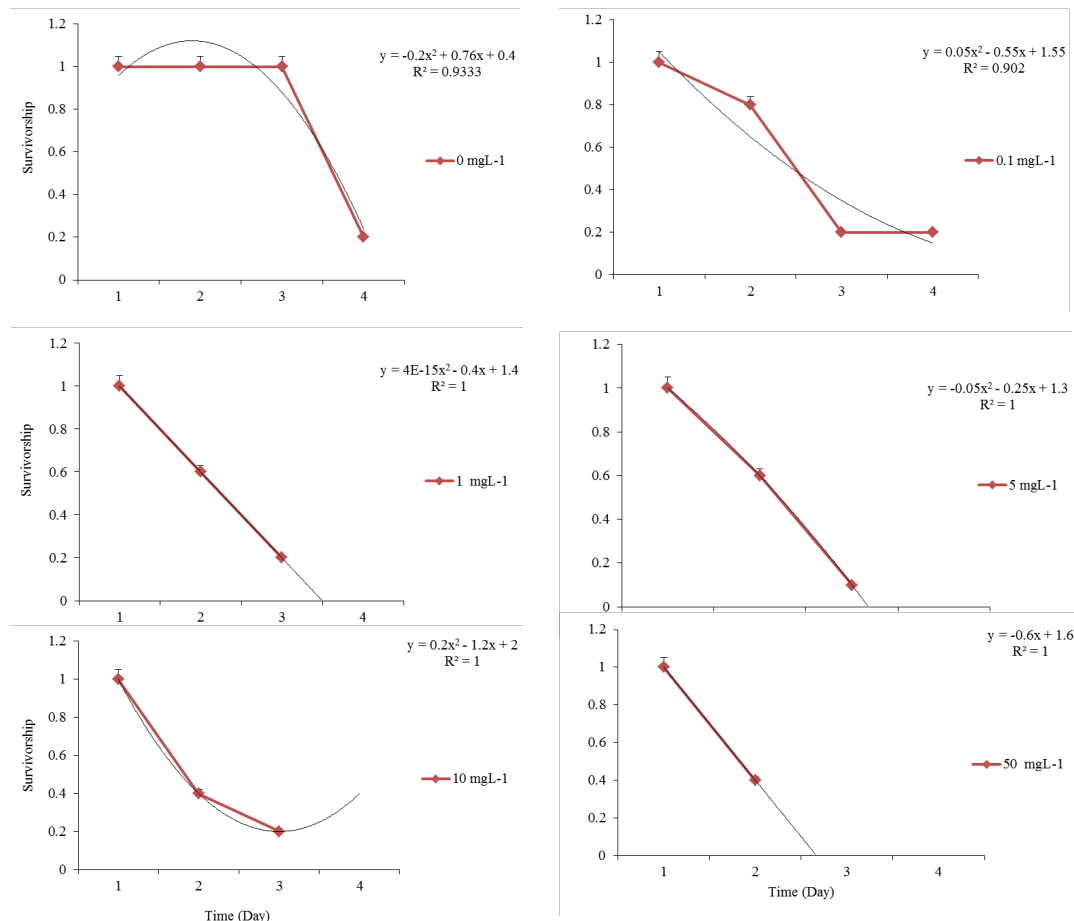

Figure 4. Survivorship curves of *D. magna* under different npZnO concentrations (with regression equations) in acute 96h experiments ($n = 6$; \pm Standard error; $P < 0.05$)

Survival rates were found for 0.1 mgL^{-1} , 1.0 mgL^{-1} , 5 mgL^{-1} , 10 mgL^{-1} and 50 mgL^{-1} npZnO concentrations ($r^2=0.93$, 80%; $r^2=0.90$, 55%; 45%; 45%; 35% and 30% respectively, corresponding 95% confidence intervals, Figure 4). Although, in general, higher immobilization to *D. magna* was observed with 24 h aged npZnO test suspensions, the

responses didnot follow monotonous concentration [9]. However, in the presentstudy immobilization was observed with 0.1 mgL⁻¹ at 48 h.

The toxic effects of these two nanoparticles that are commonly used in industry have complex synergistically effects in the ecosystem. Cocktail concentrations of npTiO₂ and npZnO have more toxicity (Figure 5).Survival rates were determined for 0.1 mgL⁻¹, 1.0 mgL⁻¹, 5 mgL⁻¹, 10 mgL⁻¹ and 50 mgL⁻¹cocktail concentrations (80%; 55%; 45%; 40%; 30% and 30% respectively, Figure 5). Toxicity of cocktail treatment to *D. magna* revealed 96h-LC₅₀value of 0.1 mgL⁻¹(95%confidence intervals).

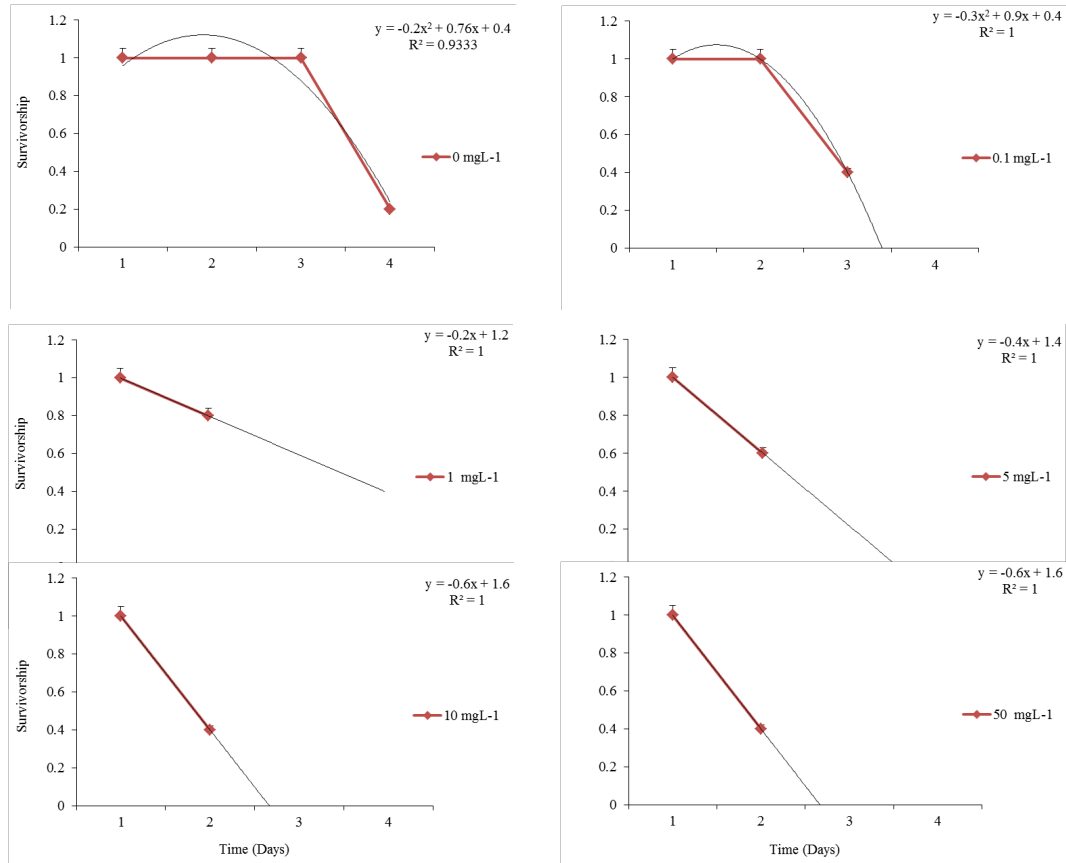

Figure 5. Survivorship curves of *D. magna* under different cocktail concentration of npTiO₂ and npZnO (with regression equations) in acute 96h experiments (n = 6; ± Standard error; P < 0.05)

The toxic effect of npZnO is due to their solubility. ZnO nanoparticles dissolve in the extracellular region, which in turn increases the intracellular Zn²⁺ level [9]. npZnO toxicity is believed to be linked to Zn²⁺ ion release [10]. ZnO nanoparticles dissolve in the extracellular region and increase in the intracellular Zn²⁺ level. Increased intracellular Zn²⁺ level reduces the activity [9].

Reference [10] reported that under the different testing conditions, npTiO₂ tested in concentrations up to 100 mgL⁻¹ did not cause immobilization of *D. magna*. This was also supported by earlier studies that revealed npTiO₂ to be generally nontoxic to *D. magna* in dark conditions. In the present study, the toxicity of nanoparticles to *D. magna* is tested in 16: 8h (light: dark) photoperiod. However npTiO₂ was found toxic at low concentrations (96 h LC₅₀ was 1.8 mgL⁻¹).

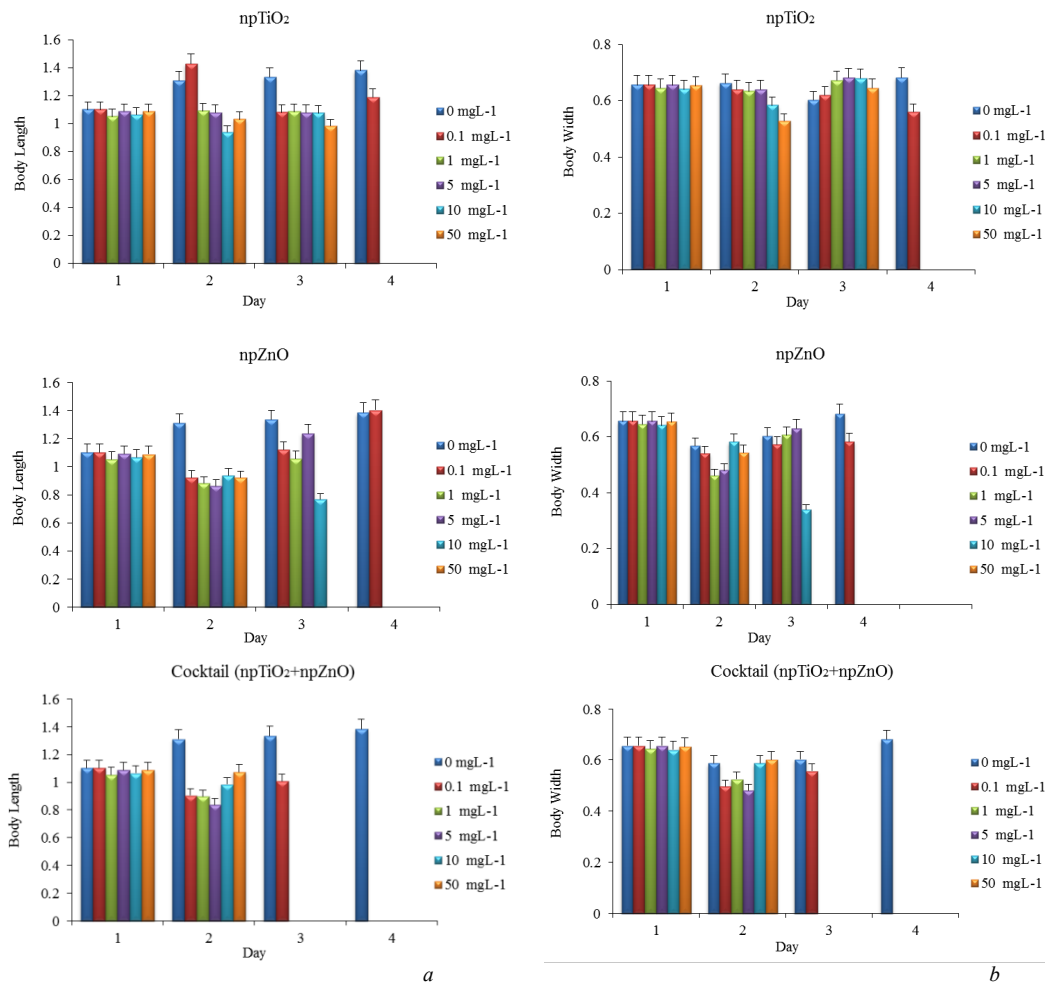

Figure 6. Morphometric data of *D. magna* under different nanoparticles and concentrations a) body length (mm); b) body width (mm) during the acute test 96h.

As shown Figure 6, the length measurement of the *D. magna* at the end of the exposure to npTiO₂ showed that there is a significant difference between the control group and the 0.1 mgL⁻¹ treatment., with *D. magna* from the 0.1 mgL⁻¹ treatment being larger (p= 0.016). There was no significant difference between the control and the other treatment.

The surviving *D. magna* of the exposure were measured to assess differences in growth over the exposure duration (96 h). A significant reduction was observed in the body length and width of *D. magna* after 24 h for npZnO and cocktail treatment when compared to the control group (Figure 6). The 5 mgL⁻¹ and 10 mgL⁻¹ exposures also induced a significant decrease in body size compared to all other treatments (p < 0.001). The accumulation of nanoparticles in the gut could lead to transfer of considerable amounts to higher trophic levels in the food chain of the aquatic environment with effects yet not investigated for *D. magna* [12].

Consequently, it is possible for nanoparticles to be ingested and accumulated readily in the digestive system and carapace in significant concentrations and that a potential exists for these ingested nanoparticles for translocation with possible toxic effects.

TiO₂ and ZnO nanomaterials have found commonly potential industrial and cosmetics applications, but life cycle of these nanoparticles on the environmental impact is not fully understood mainly because of lack of characterization factors for the life cycle impact assessment on the aquatic ecosystem.

ACKNOWLEDGMENT

The author wish to thank Assoc.Prof.Süleyman Köytepe (Inonu University, Dept. of Chemistry) which provides npTiO₂ and np ZnO.

REFERENCES

- [1] EPA, "Nanomaterial case studies: nanoscale titanium dioxide in water treatment and in topical sunscreen", Report no: EPA/600/R-09/057F, 2010.
- [2] P. Oleszczuk, I. Jos'ko and E. Skwarek, "Surfactants decrease the toxicity of ZnO, TiO₂ and Ni nanoparticles to *Daphnia magna*", *Ecotoxicology*, DOI 10.1007/s10646-015-1529-2, 2016.
- [3] C. Tan and W.X. Wang, "Modification of metal bioaccumulation and toxicity in *Daphnia magna* by titanium dioxide nanoparticles", *Environ. Pollut.*, vol. 186, pp. 36-42, 2014.
- [4] T.Y. Suman, S.R.R. Rajasree and R.Kirubakaran, "Evaluation of zinc oxide nanoparticles toxicity on marine algae chlorella vulgaris through flow cytometric, cytotoxicity and oxidative stress analysis", *Ecotoxicol. Env. Safety*, vol. 113, pp. 23-30, 2015.
- [5] J.H. Zar, *Biostatistical Analysis*. 3rd ed. Prentice Hall. NY, USA, 1996.
- [6] D.J. Finney, *Probit Analysis*, Cambridge University Press, London, 1971.
- [7] R. Bacchetta, B. Maran, M. Marelli, N. Santo and P. Tremolada, "Role of soluble zinc in ZnO nanoparticle cytotoxicity in *Daphnia magna*: a morphological approach", *Environ. Res.*, vol. 148, pp. 376-385, 2016.
- [8] D.W. Xiong, T. Fang, L.P. Yu, X.F. Sima, and W.T. Zhu, "Effects of nano-scale TiO₂, ZnO and their bulk counter parts on zebrafish: acute toxicity, oxidative stress and oxidative damage", *Sci.Total Environ.*, vol. 409, pp. 1444-1452, 2011.
- [9] M. Pandurangan and D.H. Kim, "In vitro toxicity of zinc oxide nanoparticles: a review", *J. Nanopart. Res.*, vol.17, pp. 158, 2015. DOI 10.1007/s11051-015-2958-9.
- [10] D. Cupi, N.B. Hartmann and A. Baun, "The influence of natural organic matter and aging on suspension stability in guideline toxicity testing of silver, zinc oxide, and titanium dioxide nanoparticles with *Daphnia magna*", *Environ. Toxicol. Chem.*, vol. 34, pp. 497-506, 2015.
- [11] P. S. Bedi and A. Kaur, "An overview on uses of zinc oxide nanoparticles", *World J. Pharmacy Pharmaceutic. Sci.*, vol. 4, pp. 1177-1196, 2015.
- [12] P.W. Rosenkranz, "*The ecotoxicology of nanoparticles in Daphnia magna*", Doctoral Thesis, the Edinburgh Napier University, Edinburgh, 2010.

Relationships between Nanoparticle TiO₂ and *Daphnia magna* Population Dynamics

Didem Gokce¹

Abstract

There have not been sufficient studies on behaviour and toxicity of nanoparticles through a food chain. npTiO₂ is widely used in water treatments, yet their influences on other contaminants in the water are not well studied. There were a lot of toxicological test on *D. magna* on literatures. On the other hand a few studies have relationship between nanoparticles accumulation within *D. magna* and its population structure due to lifetable parameters. It is an important indicator that its tolerance level to nanoparticles on laboratory condition is reflected its replace and behaviour in the ecosystem. Furthermore daphnids are largely disturbed in freshwater ecosystem and present through a wide range of habitats in Turkey.

D. magna, experiments were initiated with neonates obtained from the same bulk culture (laboratory condition is 24 ± 1 °C; 16: 8 h photoperiod). Experiments were carried out in glass beakers (five groups per treatment) containing 50 mL of test solutions. *D. magna* individuals were exposed to different npTiO₂ concentrations for 21 days; 30 animals (randomly divided six animals) were used per control and per npTiO₂ concentration (0.5, 1.0, 1.5, and 2.0 mgL⁻¹). The differences between nanoparticle concentrations and population life table parameters (survivorship rate, growth rate, net reproductive rate, and total progeny of each npTiO₂ concentration) were evaluating using Tukey's test. Consequently, as npTiO₂ concentration increased, mortality rate and development period were increased; total progeny and net reproductive rate were decreased. These effects on its own were produced a reduction in population growth rate and body morphometry during 21 days.

Keywords: *Daphnia magna*, life table, nanoparticle, population, survive, titanium dioxide, tolerance

1. INTRODUCTION

Engineered nanoparticle's use is increasing quickly in the world and it is used widely in many products. Environmental impacts- exposure of the organisms and the environment are not clear. The main nanoparticles used commonly in the cosmetic industry, TiO₂, is thought not to be able to penetrate healthy skin deep enough to pose a danger to human health [1], [2]; on the other hand, according to [3] it was observed in the cytological studies that intensive npTiO₂ use can penetrate into dermal layer. Nanoparticle titanium dioxide (npTiO₂) is widely used in water treatments, cosmetics, drug and paint industries, yet their influences on other contaminants in the water are not well studied [3]. There have not been sufficient studies on behaviour and toxicity of nanoparticles through a food chain.

Daphnia is a main aquatic organism in the limnetic of lake and offers a vital relationship between primary producer and higher trophic levels due to its feeding habits. Among freshwater organisms, daphnids have relatively high sensitivity to environmental contaminants [4]. Upon exposure to environmental stressors, daphnids exhibit significant reproductive decline, unusual vertical mobility and behavioural pattern, and ultimately phenoplasticity [5], [6].

Previously, there were a lot of toxicological test on *D. magna* on literatures [3], [7]. On the other hand a few studies have relationship between nanoparticles accumulation within *D. magna* and its population structure due to lifetable parameters. It is an important indicator that its tolerance level to nanoparticles on laboratory condition is reflected its replace and behaviour in the ecosystem. Furthermore daphnids are largely disturbed in freshwater ecosystem and present through a wide range of habitats in Turkey [8]. As an explained reason above, daphnids were selected for use in this study.

The physical/ chemical pollution that encountered in any time interval of the population affects patterns of survival and reproduction on population dynamics and ecosystem balance.

A species sensitivity distribution of the examined cladoceran species is descriptive for ecological risk assessment even though the information is limited to only a particular functional group [7], [9]. Considering that *D. magna* is at the base of the food chain in aquatic ecosystems, studying the relationship between the accumulation and the transportation of nanoparticles within this organism and their acute and chronic toxicity will offer important insights into the broad impact of nanoparticles in aquatic environments.

¹ Corresponding author: Inonu University, Department of Biology, Limnology Research Laboratory, 44280, Campus/Malatya, Turkey. didem.gokce@inonu.edu.tr

In this study, tolerance capacity to change npTiO₂ levels of *D. magna* species is very important to reflect possible changes occurring in the ecosystem. The aim of this study is to present the current state of knowledge regarding the effects of nanoparticle on life parameters and body size structure of the freshwater crustaceans, *Daphnia magna* (Starus 1820).

2. MATERIAL AND METHODS

2.1. Laboratory condition and *Daphnia magna*

D. magna colonies for chronic experiments of npTiO₂ were obtained *Daphnia magna* culture for 6 years in the Plankton Culture- Limnology Research Laboratory (Inonu University, Hydrobiology Section). The experiments were started when the water had approximately the ambient air temperature of the laboratory since the temperature is more important in regulating production than feeding. No other acclimation was conducted (laboratory condition is 24 ± 1 °C and 16: 8 h photoperiod). The water was used in experiments was aerated with an air pump and new fresh medium was prepared every day. pH of test solutions has range 8.0-8.2. The culture of *D. magna* is fed on a few drops of a suspension of fresh yeast and soy bean flour.

2.2. Chronic Assay

A chronic toxicity test spans often over a wider range of the organisms' life cycle, and includes more than one single exposure due to water changes that normally are conducted at regular intervals. Endpoints used to assess the effect of chronic exposures depend mostly on characteristics specific to the organisms' life cycle [3]. These include number of offspring for organisms with a short life cycle.

For chronic assay of *D. magna*, experiments were initiated with neonates (< 24-h-old) obtained from the same bulk culture. Experiments were carried out in borosilicate glass beakers (five groups per treatment) containing 50 mL of test solutions. *D. magna* individuals were exposed to different npTiO₂ concentrations for 21 days; 30 animals (randomly divided six animals) were used per control and per npTiO₂ concentration (0.5, 1.0, 1.5, and 2.0 mgL⁻¹). Chronic assays were performed triplicate for all test groups. Transfer pipettes were cleaned between transfers in to the beakers. During long term chronic exposures (21 days), media solution of each concentration group were refilled fresh homogenised their solution by 30 min of ultra-sonication everyday due to npTiO₂ sedimentation. For this reason every day, nutrition was added in each group. Vessels were checked for immobilised individuals, at 24 h, to conduct posterior determination of LC₅₀ values.

D. magna was recorded with number of surviving parthenogenetic females, number of clutches produced and age at first reproduction in each treatment group. Morphometric data as body length and width of *D. magna* photography in each treatment group was taken by using a stereomicroscope (Leica MZ 7.5 with DFC 280 camera attachment- Leica Applications Suite software, Version 2.4.0R1) throughout the study.

2.3. Data Analysis

All experiments were repeated three times independently, and data were recorded as the mean with standard deviation (SD). Survivorship rate (*lx*), growth rate, total progeny, and net reproductive rate (*R₀*) were estimated for each salinity group and species. Euler's equation was used for the calculation of the population growth [10], [11].

The differences between nanoparticle concentrations and population life table parameters (survivorship rate, growth rate, net reproductive rate, and total progeny of each npTiO₂ concentration) and morphometry (body length and width) were evaluating using Tukey's test followed by PosHoc comparison (ANOVA) [12]. The LC₅₀ values and their 95% confidence intervals were determined with Probit analysis [13]. SPSS 15.0 software program was used to conduct all statistical analyses.

3. RESULTS AND DISCUSSION

3.1. Survivorship

Survivorship curves illustrated patterns of survivorship and mortality in population. Therefore it uses to predict the future growth or decline of population. In the 21-day laboratory experiments, survival rates 90.5 % were found in control group for *D. magna*. The *in-situ* survival rates of npTiO₂ concentrations decreased for 0.5 mgL⁻¹, 1.0 mgL⁻¹, 1.5 mgL⁻¹ and 2.5 mgL⁻¹ (72.2%, 59.2%, 38.9% and 32.1% respectively, Figure 1). Individuals have low survivorship toward end of the exposure time. Mortality drastically increased except control (0 mgL⁻¹) and 0.5 mgL⁻¹ in after 3th day. As results of ANOVA, significant differences were determined control and the other treatment groups) (p < 0.02, F = 14.528, one-way ANOVA).

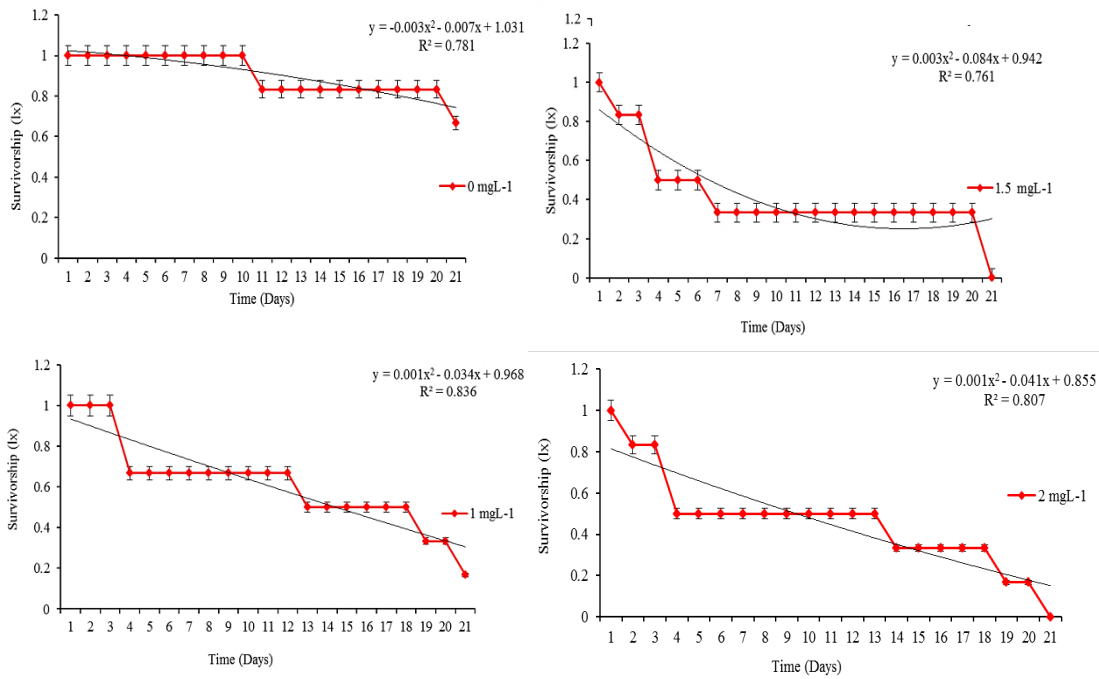

Figure 1. Survivorship curves of *D. magna* under different npTiO₂ concentrations (with regression equations) in 21 days experiments ($n = 6$; \pm Standard error; $P < 0.05$)

D. magna sensitivity examined to determine the 21 d- LC₅₀. All calculations of mean and standard deviation made on the basis of log (LC₅₀) and 95% confidence interval. The LC₅₀ value was determined 1.0 mgL⁻¹. According to LC₅₀ value, mortalities in survivorship curves increased at these concentrations.

3.2. Population Parameters

Neonate and young individuals were more sensitive to the death due to their tolerance. As seen Figure 1, towards the end of the application period, the increase in deaths is noteworthy. This result was effected population progeny ($r^2=0.99$) and growth rates ($r^2= 0.87$) (Figures 2 and 3).

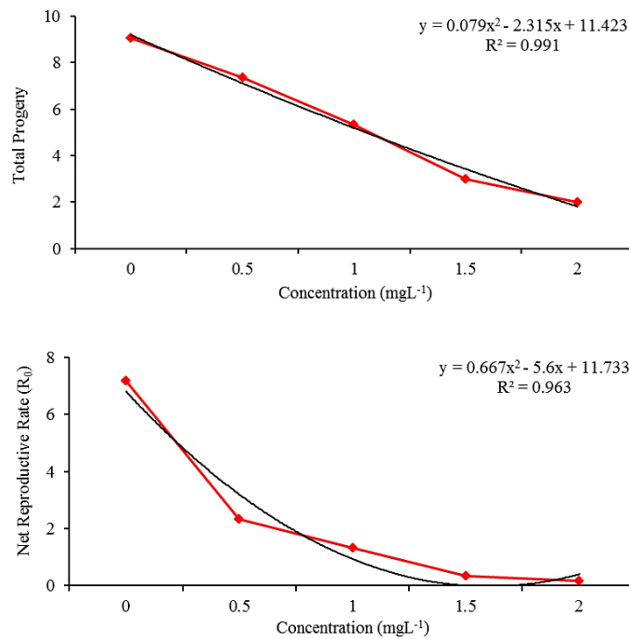

Figure 2. Total progeny and net reproductive rate curve of *D. magna* under different npTiO₂ concentrations (with regression equations; n=6; ± Standard error; P < 0.05)

The net reproductive rate is the lifetime reproductive potential of the adults individuals for daphnids. Assuming survival and fertility schemes remain constant over time, if $R_0 > 1$, the population will grow exponentially. If $R_0 < 1$, the population will shrink exponentially, and if $R_0 = 1$, the population size will not change over time. The control and 0.5 mgL⁻¹ npTiO₂ groups were determined as growing population due to R_0 values (R_0 values are 7.2 and 2.4 respectively). Especially 1.5 and 2 mgL⁻¹ npTiO₂ groups have decreased population size (R_0 values are 0.3 and 0 respectively). Total progeny and net reproductive rates of *D. magna* are seen in Figure 2.

Population growth rate is the most significant properties of the population structure. Population growth rate depends on individuals' birth and death rates and on the timing of their breeding attempts. Together, these characterize the individuals' life histories. In general, however, mortality, birth and growth rates may change with age.

The net result is that population growth rate is a negative linear function of population density (Figure 3). This population density is called the carrying capacity of the ecosystem in which the *D. magna* population lives. Thus LC₅₀ (1 mgL⁻¹ npTiO₂) was effected patches of energy transfer in the aquatic ecosystem.

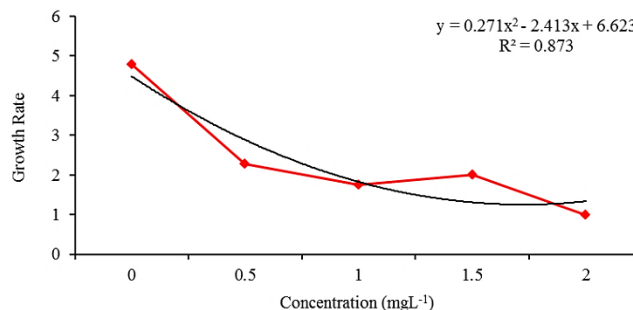

Figure 3. Population growth rate curve of *D. magna* under different npTiO₂ concentrations (with regression equations; n=6; ± Standard error; P < 0.05)

Water insoluble nanoparticles such as npTiO_2 , are accumulated in the legs and carapace of *D. magna* during the filtration of the water. Furthermore during the nutrient uptake, nanoparticles easily accumulate in the digestive system (Figure 4).

Reference [14] claimed that previous ecotoxicity studies with npTiO_2 on *D. magna* often focused on exposure concentration, the physicochemical properties of nanoparticles. Reference [15] reported that npTiO_2 (25 nm or 100 nm) concentrations of less than 3 mgL^{-1} exhibited little effect on the immobilization of daphnids. In this study the mortality was observed in the 0.5 mgL^{-1} npTiO_2 group of 4th day. The LC_{50} was calculated as 1 mgL^{-1} npTiO_2 . Consequently, in the more low concentration of 2 mg immobilized and death it was observed. This ultimately affected population structure (Figure 1, 2 and 3).

3.3. Morphometric Data

Nanoparticles input into environment through the contamination of sewage effluents into surface waters. Therefore, the toxicity of surfactants is very important in the prediction of environmental hazard related with their presence in the environment. Chronic and sub-lethal toxicity of metallic nanoparticles with relation to aquatic organisms, that appeared at concentrations higher than LC_{50} 1 mgL^{-1} npTiO_2 in this study. Increasing concentration of 0.5 mgL^{-1} npTiO_2 caused an increase in the rate of immobility and death of *D. magna* due to tolerance (Figure 1).

The main potential mechanism of npTiO_2 toxicity causes oxidative stress with reactive oxygen species (ROS), which damages lipids, carbohydrates, proteins, and DNA. According to [16], the exposure of living cells to zinc salt resulted in substantial respiration block, mitochondrial structural alterations with changes in mitochondrial permeability and formation of ROS with H_2O_2 generation. It is estimated that npTiO_2 can alter mitochondria membrane permeability in the gut especially.

As seen Figure 4, body growth was slowed due to concentration during the exposure time. While neonates in control group have normal development, the maturation period of neonates in increasing concentrations slowed. Body length and width of control group were normal morphometric ration. It seen that allometry was became progressively worse in concentrations of more than 1 mgL^{-1} npTiO_2 .

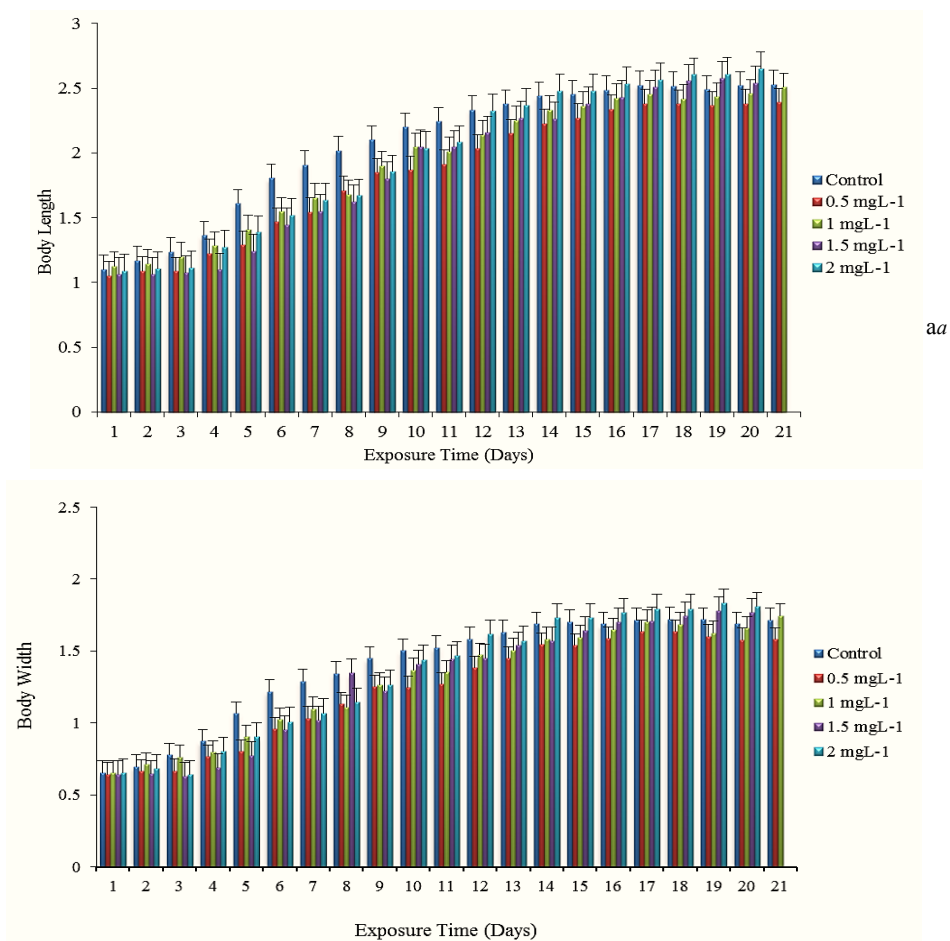

Figure 4. Morphometric data of *D. magna* as a) body length; b) body width during the chronic assay 21-days.

The size and shape of nanomaterials have a direct and significant impact on the physiological activity especially respiration and digestion (Figure 5).

The size of nanomaterials has a direct and significant impact on the physiological activity. The np size plays a critical role in cellular uptake, efficiency of particle processing in the endocytic pathway, and physiological response of cells to NPs [17].

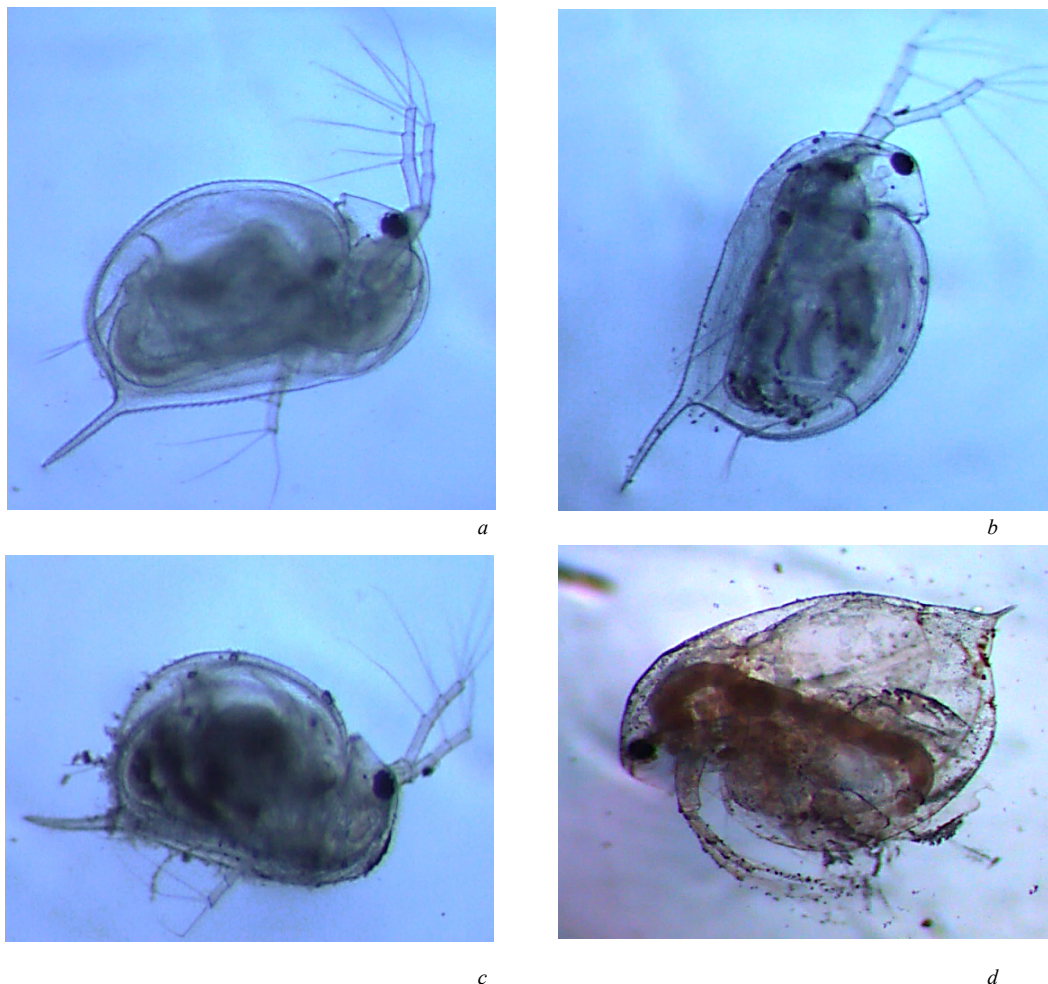

Figure 5. *D. magna* individual a) in the control group, 3th day; b) exposed to 0.5 mgL^{-1} npTiO_2 , 3th day; c) exposed to 1.5 mgL^{-1} npTiO_2 , 4th day; d) exposed to 0.5 mgL^{-1} npTiO_2 , 21st day; npTiO_2 was seen in digestion system and the carapace (magnification 40x; photo: D. Gokce).

According to this result, firstly 1.0 mgL^{-1} npTiO_2 or higher concentrations in the aquatic ecosystem will cause *D. magna* population decline. Secondly, both of exposure concentration and duration was important factors in npTiO_2 toxicity.

As npTiO_2 concentration increased, mortality rate and development period were increased; total progeny and net reproductive rate were decreased. These effects on its own were produced a reduction in population growth rate during 21 days. Thus the reduction of population growth rate with increasing nanoparticle concentration was due to equally to delay of progeny, mortality rate and first reproduction period.

Taken together, these findings indicate that npTiO_2 exposure, especially for long periods of time, may exert negative impact on population of aquatic organisms and on food web dynamics in aquatic systems.

ACKNOWLEDGMENT

The author wish to thank Assoc.Prof.Süleyman Köytepe (Inonu University, Dept. of Chemistry) which provides npTiO_2 .

REFERENCES

- [1] S. E. Cross., B. Innes, M. S. Roberts., T. Tsuzuki, T. A. Robertson and P., "McCormick, "Human skin penetration of sunscreen nanoparticles: in-vitro assessment of a novel micronized zinc oxide formulation". *Skin Pharmacol Physiol*, vol.20, pp.148-54, 2007.
- [2] K.J. Kulacki and B.J. Cardinale, "Effects of nano-titanium dioxide on freshwater algal population dynamics". *PLoS ONE* vol. 7(10), e47130, doi: 10.1371/, 2012.
- [3] EPA, "Nanomaterial case studies: nanoscale titanium dioxide in water treatment and in topical sunscreen", Report no: EPA/600/R-09/057F, 2010.
- [4] D.W. Schindler, "Detecting ecosystem responses to anthropogenic stress" *Can. J. Fish. Aquat. Sci.*, vol. 44, pp. 6–25, 1987.
- [5] A.Gerhardt, B.L. de Bisthoven and A.M.V. Soares, "Evidence for the stepwise stress model: *Gambusiaholbrooki* and *Daphnia magna* under acid mine drainage and acidified reference water stress", *Environ. Sci. Technol.*, vol. 39, pp. 4150–4158,2005.
- [6] D. Gökçe and D.O. Turhan, "Effects of salinity tolerances on survival and life history of 2 cladocerans", *Tr J Zool*, 38: 347-353, 2014.
- [7] H.J. Kim, P. Koedrith and Y.R. Young Rok Seo, "Ecotoxicogenomic approaches for understanding molecular mechanisms of environmental chemical toxicity using aquatic invertebrate, *Daphnia* model organism". *Internat Jour Molecular Sci*, vol. 16, pp. 12261-12287, 2015.
- [8] M.R. Ustaoglu, "An updated zooplankton biodiversity of Turkish inland waters" *LimnoFish* vol. 1(3), pp. 151-159, 2015.
- [9] H.J. Dumont, S.V. Negrea, Introduction to the class Branchiopoda. In: Dumont HJF, editor. *Guides to the Identification of the Microcrustaceans of the Continental Waters of the World*. Leiden, the Netherlands: Backhuys Publishers. (2002).
- [10] W.M.I. de Coen and C.R. Janssen, "The missing biomarker link: relationships between effects on the cellular energy allocation biomarker of toxicant-stressed *Daphnia magna* and corresponding population characteristics", *Environ Toxicol Chem.*, vol. 22: pp. 1632–1641, 2003.
- [11] S.C. Antunes, B.B. Castro and F. Goncalves, "Effects of food level on the chronic and acute responses of daphnids to lindane", *Environ Pollut.*, vol. 127 pp. 367–375, 2004.
- [12] J.H. Zar, *Biostatistical Analysis*. 3rd ed. Prentice Hall. NY, USA, 1996.
- [13] D.J. Finney, *Probit Analysis*, Cambridge University Press, London, 1971.
- [14] X. Zhu, Y. Chang, Y. Chen, "Toxicity and bioaccumulation of TiO₂ nanoparticle aggregates in *Daphnia magna*", *Chemosphere*, vol. 78, pp. 209–215, 2010.
- [15] K. Hund-Rinke and M. Simon., "Ecotoxic effect of photocatalytic active nanoparticles (TiO₂) on algae and daphnids", *Environ. Sci. Pollut. Res.* 13, 225– 232, 2006.
- [16] R. Bacchetta, B. Maran, M. Marelli, N. Santo and P. Tremolada, "Role of soluble zinc in ZnO nanoparticle cytotoxicity in *Daphnia magna*: a morphological approach", *Environ. Res.*, vol.148, pp. 376–385, 2016.
- [17] M. González-Muñoz, P. Díez, M. González-González, R.M Dégano, N. Ibarrola, A. Orfao and M. Fuentes *Evaluation Strategies of Nanomaterials Toxicity, Nanomaterials - Toxicity and Risk Assessment*, ed., M. Larramendy, Germany, InTech, 2015.

Catalytic Gasification of Galacturonic Acid as a Model Compound for Hemicelluloses

Dilek Selvi Gokkaya, Mehmet Saglam, Mithat Yuksel, Levent Ballice

Abstract

Production of Hydrogen and Methane which are used as clean energy sources by hydrothermal gasification from the lignocellulosic biomasses is a novel and developing technology. Biomass is mainly composed of cellulose, hemicellulose, lignin, and extractives and the compositions vary depending on the source of the biomass. Hemicellulose is chained and amorphous biopolymer composed of the primary monomer constituents, hexoses (glucose, galactose, mannose, glucuronic acid and galacturonic acid), pentoses (xylose, arabinose). Cellulose, lignin, hemicelluloses, and extractive substances show different attitudes in hydrothermal gasification. For this reason, significant varieties are observed in the gasification yields and product distributions. From this point, in this study galacturonic acid as model compounds for the hemicellulose was studied. The catalyst decomposition of galacturonic acid was examined in supercritical water for temperature from 300 to 600°C. Experiments were performed in the absence and presence of metal impregnated activated carbons (Ni/AC) and (Ru/AC) with a reaction time of 1h. The yields of gas, liquid, and solid products were identified with the analyses using gas chromatography (GC), high performance liquid chromatography (HPLC), total organic carbon analyzer (TOC), and solid sample module (SSM). The effect of the reaction temperature, and catalyst were investigated to reach the maximum yields of H₂ and CH₄. The highest H₂ yield and the highest CH₄ yield were obtained at the highest reaction temperature by using Ru/AC and Ni/AC, respectively.

Keywords: Biomass, galacturonic acid, supercritical water, gasification, hydrogen

1. INTRODUCTION

New alternative energy sources need to be explored, because of fossil energy sources have limited reservations and important environmental issues are occurring. In these alternative energy sources, biomass being CO₂ neutral and a readily available source of energy is considered to be renewable. Several processes have been explored to produce valuable gases from the lignocellulosic biomasses. In the last two decades, a novel gasification technology called supercritical water gasification has been developed, in which water having a pressure of over 22.1 MPa and a temperature of over 374°C (i.e. supercritical conditions) is used as the gasifying agent [1-10]. The major properties of supercritical water, such as density, viscosity, dielectric constant, and dipole moment, are quite different from standard conditions, so it utilizes water as a solvent and as a reactant at the same time. These advantages increase the thermal efficiency of the supercritical water gasification process as compared to dry gasification processes [11, 12].

Plant biomass generally has a complex structure and is mainly composed of cellulose, hemicelluloses, lignin, extractives, and ash forming inorganic materials. Cellulose is a polysaccharide consisting of a linear chain of β-D glucose units. Hemicelluloses, which are a stable carbohydrate polysaccharide, are part of that fall outside of cellulose of the polysaccharides which form the cell wall. They are the second abundant biopolymer next to cellulose. A 4-5% soluble portion in cold alkaline solution of the plant is referred to as hemicelluloses according to the opinion adopted in the literature. While the degree of polymerization (DP) for the cellulose is in the range of 5000-10000, this range decreases to 150 for the hemicelluloses. Long chained and amorphous biopolymer hemicelluloses are composed of the primary monomer constituents, hexoses (glucose, galactose, mannose, glucuronic acid and galacturonic acid), pentoses (xylose, arabinose) [13]. Within the plant, these monomers which are forming homopolymer (glucan, mannan, galactan, xylan, arabinan etc.) or copolymer (glucomannan, arabinogalactan, etc.) structures are linked to lignin or cellulose by chemical bonds and thus fixed in the fiber structure [14]. The lower chemical and thermal stability of hemicellulose compared to cellulose can also be attributed to the lower degree of polymerization. Hemicellulose exists in biomass in different compositions and structures containing irregular side chains.

Cellulose, lignin, hemicelluloses, and extractive substances show different attitudes in hydrothermal gasification. For this reason, significant varieties are observed in the gasification yields and product distributions. From this point, in this study galacturonic acid as model compounds for the hemicellulose was studied.

In this study supercritical water gasification of galacturonic acid as model compounds for the hemicellulose was studied. The catalyst decomposition of galacturonic acid was examined in supercritical water for temperature from 300 to 600°C. Experiments were performed in the absence and presence of metal impregnated activated carbons (Ni/AC) and (Ru/AC) with a reaction time of 1h. The yields of gas, liquid, and solid products were identified with the analyses using gas chromatography (GC), high performance liquid chromatography (HPLC), total organic carbon analyzer (TOC), and solid sample module (SSM). The effect of the reaction temperature, and catalyst were

investigated to reach the maximum yields of H₂ and CH₄. The highest H₂ yield and the highest CH₄ yield were obtained at the highest reaction temperature by using Ru/AC and Ni/AC, respectively.

2. MATERIALS AND METHODS

Galacturonic acid of 99% purity used in the experiments was obtained from Alfa Aesar. The AC (Charcoal activated, Merck) was used as a support for nickel and ruthenium catalysts. Ni/AC and Ru/AC catalysts formulations have been studied using wet impregnation method. Nickel nitrate hexahydrate [Ni(NO₃)₂·6H₂O] was used as a precursor for the preparation of the Ni/AC, purchased from Merck. Ruthenium (III) chloride hydrate [RuCl₃·xH₂O] was used as a precursor for the preparation of Ru/AC, purchased from Sigma Aldrich. Ni and Ru loading were 5 wt% in the ACs. Catalysts (AC, Ni/AC, and Ru/C) were characterized to obtain information on the surface area, total pore volume, and the surface morphologies. Detailed procedures and characterizations can be found in our previous publication [15].

Catalytic gasification experiments were conducted in a stainless steel batch reactor setup. To examine the effect of temperature on the product yield and composition, a total of 1.2 g of galacturonic acid and 10 wt.% of catalyst were mixed and loaded into the reactor with 15 ml of water. In order to see the catalyst effect, the experiments were performed without and with adding catalysts. The temperature and pressure are controlled by the analogue manometer and thermocouple. Mixing was achieved by a motor-driven tumbling movement. Description of the experimental setup was given in the Figure 1.

After loading feed mixture into the autoclave, it is flushed by inert nitrogen gas to remove all air in the reactor. Prior to each experiment the reactor was heated to the desired reaction temperature at 8-10 K min⁻¹ and was held at the reaction temperature using a PID temperature controller for 60 min, which was found to be optimum from our previous studies. At the end of the reaction time, the reactor was rapidly cooled by quenching in cold water and allowed to reach the ambient temperature. The amount of gases formed was measured with a gasometer after expansion to ambient pressure and gas samples were taken using gas tight syringes for gas chromatography analysis. The gas volume was measured in ±10 % accuracy. Liquid and solid products that remained in the reactor after gas sampling were washed out with water and filtrated to separate solid residue (coke). pH of aqueous products was lowered to 2 by addition of 1-2 drops of concentrated sulphuric acid which was required to inhibit ionization of organic acids.

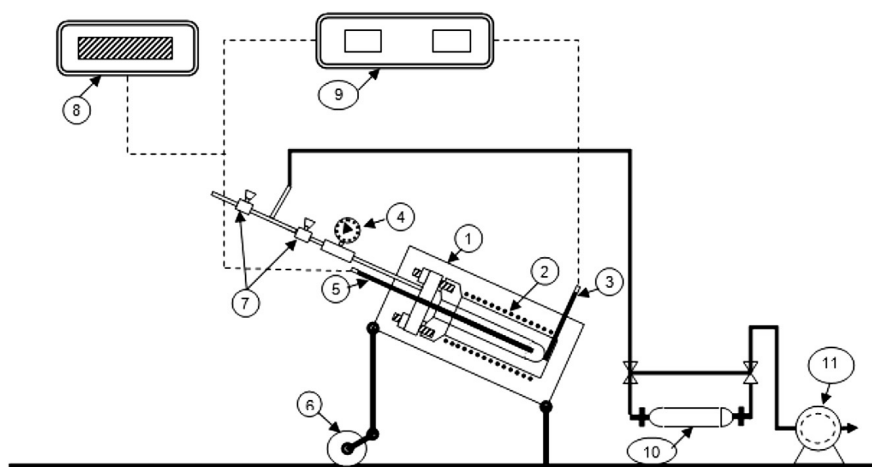

Figure 1. Schematic diagram of the SCWG system; 1, autoclave; 2, electrical heater; 3, outside thermocouple; 4, pressure gauge; 5, inner thermocouple; 6, rotating shaker with an eccentric; 7, high pressure valves; 8, recorder; 9, PID controller; 10, gas sample outlet; 11, gasometer.

2.1 Analysis of Gaseous and Aqueous Product, and Solid Residue

Gaseous products were analyzed by a gas chromatography (GC). The gas chromatography (HP 7890A, Wilmington–USA) was equipped with serially connected seven columns; Hayesep Q 80/100 mesh (0.5 m long × 2 mm i.d.), Hayesep Q 80/100 mesh (1.8 m long × 2 mm i.d.), Molsieve 5A 60/80 mesh (2.4 m long × 2 mm i.d.), Hayesep Q 80/100 mesh (0.9 m long × 2 mm i.d.), Molsieve 5A 60/80 mesh (2.4 m long × 2 mm i.d.), DB-1 (pre-column) and HP-Plot Al₂O₃ S (25 m long × 0.32 mm i.d.) columns. Two thermal conductivity detectors (TCD) and a flame ionization detector (FID) were arranged serially. Helium was used as carrier gas and oven temperature program was in the following: the oven temperature firstly was held 60 °C isothermal for 1 min, then reached to 80 °C at a rate of 20 °C min⁻¹, and finally reached to 120 °C at a rate of 30 °C min⁻¹ for 2.66 min. Gas products were identified by retention time and quantized by external calibration against the standard gas mixture. Gas sample was injected twice

for all gas samples by gas tight syringes. The composition of the gaseous products (H_2 , CO_2 , CO and C_1 – C_4 hydrocarbons) was measured by gas chromatographic methods and were taken as an average of the two injections. The standard deviation for the results of gas composition was calculated to be $\pm 2\%$.

To determine total organic carbon (TOC) content of aqueous products were used a TOC analyzer (Shimadzu TOC-V_{CPH}, Japan). Standard solutions for the calibration were prepared by using potassium hydrogen phthalate. TOC of solid residue was measured by solid sample module of TOC analyzer (Shimadzu TOC-V_{CPH}-SSM-5000A, Japan). In order to provide precise data, the samples were analyzed in three times, and the averages were reported as results. Aqueous products were analyzed as qualitative and quantitative by high performance liquid chromatography (HPLC) system. The carbon amounts in all phases were measured, to interpretation of the carbon recovery of the experiments.

HPLC analyses were carried out using a Shimadzu LC-20A series liquid chromatography device equipped with an Inertsil ODS-4 (250 mm long \times 4.6 mm i.d.) column. The HPLC system consisted of a DGU-20AS degassing module, LC-20AT gradient pump, CTO10ASVP chromatography oven and SPD-20 multi-wavelength ultraviolet detector. Carboxylic acids, phenols and furfurals were analyzed by the method (mobile phases: A: 0.05 vol.% H_3PO_4 (pH: 2.25) – B: CH_3CN/H_2O (80/20: vol./vol.), flowrate: 1 mL/min, low temperature gradient program of mobile phase and detector: 0 min 90 % A and 10% B, 0 min detector wave-length 210 nm, 5 min detector wavelength 290 nm, 7 min detector wavelength 285 nm, 11 min detector wavelength 278 nm, 15 min detector wavelength 232 nm, 17 min 90 % A and 10 % B, 19 min detector wavelength 290 nm, 25 min 65 % A and 35% B, 27.5 min detector wavelength 290 nm, 55 min 65% A and 35 %, column temperature: 30 °C). The aldehydes and ketones were analyzed by applying Method II (mobile phases: A: water – B: methanol, flowrate: 1 mL/min, detector: UV (at 365 nm), low temperature gradient program of mobile phase: 0 min 35 % A and 65% B, 5 min 35 % A and 65 % B, 15 min 15% A and 85 % B, 30 min 10 % A and 90 % B, column temperature: 30 °C). The aldehydes and ketones were derivatized to their hydrozone forms by addition of 2,4-dinitrophenylhydrazine to aqueous samples. 2,4-dinitrophenylhydrazone forms of aldehydes and ketones were separated by reversed-phase high-performance liquid chromatography as the same method described in the literature [16]. The concentration of total phenols was determined by using Jenway Colorimeter (Model 6051, UK).

3. RESULTS AND DISCUSSION

Hydrothermal gasification of galacturonic acid were studied at the operating temperatures (300–600°C). The effect of temperature and metal impregnated activated catalyst during supercritical water gasification of galacturonic acid were examined by addition of catalysts at a constant reaction time for 1h. Experiments were performed without and with adding 10 wt% of catalysts. Since the experiments were repeated at least three times, the average yield could be evaluated and the reproducibility could be confirmed.

For the calculation of the carbon recovery of the experiments, carbon amount measured in all phases (gas, aqueous and solid phase) and carbon balance of products were obtained within 95–99 %.

Ni/AC and Ru/AC had also similar effect under the same reaction conditions, and their CGE were 79.9 and 83.2 respectively at 600°C (Table 1). Even at low temperature of 400°C, CGE was increased from 27.3% (without catalyst) to 30.7 % and 30.3 % by using Ni/AC and Ru/AC, respectively, because the onset temperature of the degradation reactions was lowered by catalysts.

Table 1. Effects of increasing temperature and using catalyst on the product efficiencies.

T (°C)	P (MPa)	Catalyst	Product Efficiency		
			CGE	CLE	RE
300	9.70	-	27.3	19.5	50.1
400	18.6	-	35.1	17.8	43.3
500	33.5	-	44.3	16.1	35.2
600	38.5	-	63.1	9.7	25.3
300	9.80	Ni/AC	30.7	21.2	47.0
400	25.5	Ni/AC	38.5	20.4	37.0
500	34.5	Ni/AC	60.6	8.4	28.9
600	45.5	Ni/AC	79.9	3.8	14.4
300	10.0	Ru/AC	30.3	21.5	45.2
400	24.0	Ru/AC	36.7	19.1	39.7
500	34.0	Ru/AC	64.7	10.3	23.2
600	46.0	Ru/AC	83.2	1.4	10.8

3.1. Gaseous product composition

The gaseous product was composed of hydrogen, carbon monoxide, carbon dioxide, and methane as major components and ethane, ethene, propane, and propene as minors. C₄- and higher hydrocarbons were not detected. As expected the gasification increased with temperature and by using catalyst. Effects of increasing temperature and using catalyst on the gas mole fractions are given in the Table 2.

Table 2. Effects of increasing temperature and using catalyst on the gas mole fractions.

T (°C)	P (MPa)	Catalyst	Gas mole fraction (mol/kg galacturonic acid)			
			CH ₄	H ₂	CO ₂	CO
300	9.70	-	0.04	0.7	8.4	2.2
400	18.6	-	0.7	3.1	9.6	1.0
500	33.5	-	1.9	3.9	10.4	0.3
600	38.5	-	4.3	7.4	13.5	0.2
300	9.80	Ni/AC	0.04	0.5	8.6	0.3
400	25.5	Ni/AC	0.4	2.3	10.7	0.3
500	34.5	Ni/AC	2.5	5.2	14.2	0.3
600	45.5	Ni/AC	5.9	10.2	17.5	0.1
300	10.0	Ru/AC	0.06	0.8	8.6	0.5
400	24.0	Ru/AC	0.5	3.5	10.0	0.4
500	36.0	Ru/AC	3.7	10.3	15.3	0.3
600	46.0	Ru/AC	5.5	15.7	19.2	0.2

As seen in the Table 2, hydrogen yield increases with increasing temperature from 400 to 600°C. Use of catalyst in supercritical water gasification lowered the activation energy for the reactions and increased the selectivity in the gas products. The results showed that H₂ yield increased significantly when the catalysts were used. The experimental results have shown that, even at low catalyst loadings (5%) for activated carbon, ruthenium and nickel were highly active for the production of hydrogen at 600°C. The highest hydrogen yield obtained with Ru/AC was about almost 2 times higher than that of obtained without catalysts at 600°C. Hydrogen production by supercritical water gasification depends also on the source of AC. In this work, charcoal activated carbon was used as a support for nickel and ruthenium catalyst. Adding Ni and Ru to the activated carbon enhanced the hydrogen production efficiency.

The concentration of CH₄ was increased as reaction temperature was raised from 400 to 600°C. Also the highest amount of CH₄ in supercritical water was catalyzed by Ni/AC to the value of 5.9 mol/kg galacturonic acid (Table 2) at 600°C. CH₄ in the product gas is produced from methanation, and hydrogasification reactions and from reactions of organic liquid intermediates [17, 18]. Minowa et al. suggested that decreased H₂ production inhibited the methanation reaction by methanation of CO (Eq.(1)) and also by CO₂ (Eq.2) [19].



3.2. Aqueous product composition

The influence of catalyst on liquid formation (g aqueous product/kg galacturonic acid) during supercritical water gasification of galacturonic acid at 300°C and 400°C are given in the Table 3.

Table 3. Effects of increasing temperature, pressure and using catalyst on the liquid products.

	Catalyst	-		Ni/AC		Ru/AC	
		300	400	300	400	300	400
Total carboxylic acids	Glycolic acid	7.76	8.29	0.05	4.32	3.35	4.90
	Formic acid	23.14	22.89	1.25	2.73	4.84	5.15
	Acetic acid	43.36	39.47	29.47	29.50	15.88	20.11
Total furfurals	5-Methyl furfural	35.39	51.84	37.14	56.70	33.80	38.79
	5-Hydroxymethyl furfural	2.80	2.43	2.49	2.17	2.54	2.20
	Furfural	0.53	0.39	0.13	0.24	0.21	0.18
Total aldehyde and ketones	3-Methyl-2-cyclopentene-1-one	0.32	0.05	0.01	0.28	0.37	0.11
	2-Cyclo-pentan-1-one	0.32	0.05	0.03	0.06	0.72	0.10
	Formaldehyde	0.01	0.02	0.01	0.00	0.01	0.00
	Acetaldehyde	1.96	0.46	1.85	0.86	0.78	0.16
	Acetone and propionaldehit	4.53	5.18	4.19	0.00	0.00	5.26
Total phenols	Phenol	0.02	0.01	0.01	0.07	0.05	0.00
	m-and p-Cresols	0.23	0.01	0.02	0.08	0.05	0.06
	o-Cresol	0.18	0.01	0.00	0.27	0.02	0.15
	Resorcinol	1.12	0.39	0.82	0.53	0.72	0.10
	Catechol	0.12	0.07	0.03	0.06	0.43	0.03
	3- Methoxycatechol	4.10	0.78	1.23	0.75	2.69	0.63
	Methoxybenzene and 4- methoxyphenol	0.19	0.05	0.03	0.01	0.02	0.01
	2,6 Dimethoxy phenol	0.95	1.92	1.63	3.11	0.94	2.26
	2-Methoxyphenol and 3- methoxyphenol	1.45	0.77	1.18	0.58	1.01	0.45
	4 Methyl guaiacol	0.51	0.31	0.32	0.18	0.47	0.19

	3,4 Dimethyl phenol	0.02	0.24	0.21	0.96	0.41	0.90
	4- Vinyl guaiacol	0.06	0.11	0.01	0.10	0.23	0.00
	3,5 Dimethyl phenol	0.01	0.08	0.11	0.09	0.03	0.12
Total phenols	Colorimetrically	3.76	4.97	4.02	5.36	3.44	5.29

The aqueous products contain large number of compounds, but only key compounds like carboxylic acids (glycolic acid, formic acid, acetic acid), total furfurals (furfural, 5-hydroxymethyl furfural, 5-methyl furfural), total phenols (o-m-p cresols, phenol, resorcinol, catechol, 3-methoxycatechol, methoxybenzene and 4-methoxyphenol, 2-methoxyphenol and 3-methoxyphenol, 2,6 dimethoxyphenol, 4- methyl guaiacol, 3,4 dimethyl phenol, 3,5 dimethyl phenol and 4-vinyl guaiacol), total aldehydes and ketones (formaldehyde, acetaldehyde, acetone, propionaldehyde, 3-methyl-2-cyclo-penten-1-one, 2-cyclo-penten-1-one) were identified to interpret the effects.

Aqueous product contained high concentrations of carboxylic acids such as glycolic acid, acetic acid and formic acid which are degradation products of furfural or 5-HMF. Ni/AC and Ru/AC are good catalysts for the formation of carboxylic acids. The aqueous product includes a lot of different phenols. Ortho-, para-, meta-cresols and phenols are analyzed by HPLC and the sum of phenols is detected colorimetrically. The phenols amount is the lowest in the presence of Ru/AC and the highest by without a catalyst. Ruthenium seems to force the hydrogenation of phenols and potassium salt catalyzes the formation of phenols. Aqueous product yield can be ordered as total carboxylic acids > total furfurals > total aldehyde and ketones > total phenols.

4. CONCLUSIONS

This paper presents results of supercritical water gasification of galacturonic acid as a model substance for hemicellulose contained in plant biomass. Catalytic gasification of galacturonic acid was carried out over a temperature range 300 to 600 °C in supercritical water using by metal impregnated activated carbons (Ni/AC and Ru/AC).

An increase in the temperature of galacturonic acid hydrothermal gasification favored the production of larger amount of gas product and small amount of residue fractions. The compositions of the products are sensitive to temperature and the catalytic activity. Major gas products consisted of H₂ and CO₂. Two main types of catalysts (metals and carbon), when used in the supercritical water gasification process, improve the gasification efficiency and decreases the required temperature for the gasification. The highest H₂ yield was generated as 15.7 mol H₂ per kg of galacturonic acid fed by using the catalyst Ru/AC at a reaction temperature of 600°C. The reforming of CH₄ in supercritical water is catalyzed by Ni/AC to the highest value (5.9 mol/ kg of galacturonic acid).

Aqueous product yield can be ordered as total carboxylic acids > total furfurals > total aldehyde and ketones > total phenols for the reaction temperatures of 300 and 400°C. The highest aqueous product yield was reached in the presence of Ru/AC catalyst at 300°C.

ACKNOWLEDGEMENTS

We are gratefully acknowledge the financial support for this work provided by the Scientific and Technological Research Council of Turkey (TUBITAK) in the form of research project No:109M284.

REFERENCES

- [1] Kıpçak, E, Söğüt, O.Ö., Akgün, M., *Hydrothermal Gasification of olive mill wastewater as a biomass source in supercritical water*, J. Supercritical Fluids, 57, 50-57, 2011.
- [2] P. Azadi, R. Farnood, *Review of heterogeneous catalysts for sub and supercritical water gasification of biomass and wastes*, International J. of Hydrogen Energy, , 36, 9529-9554, 2011.
- [3] M. H. Waldner, F. Krumeich, F. Vogel, *Synthetic natural gas by hydrothermal gasification of biomass Selection procedure towards a stable catalyst and its sodium sulfate tolerance*, J. of Supercritical Fluids, 105, 4391, 2007.
- [4] A. Kruse, A. Gawlik, *Biomass conversion in water at 330–410°C and 30–50 MPa*, Identification of key compounds for indicating different chemical reaction pathways, Industrial and Engineering Chemistry Research 42, 267–279, 2003.
- [5] Y. Matsumura, X. Xu, M.J. Antal, *Gasification characteristics of an activated carbon in supercritical water*, Carbon, 35, 819–824, 1997.

- [6] L.K. Mudge, E.G. Baker, D.H. Mitchell, M.D. Brown, *Investigations on catalyzed steam gasification of biomass*, J. Solar Energy Engineering, 107, 89–92, 1985.
- [7] A. Kruse, E. Dinjus, *Influence of salts during hydrothermal biomass gasification: the role of the catalysed water-gas shift reaction*, Zeitschrift für Physikalische Chemie 219, 341–366, 2005.
- [8] T. Yoshida, Y. Oshima, Y. Matsumura, *Gasification of biomass model compounds and real biomass in supercritical water*, Biomass Bioenergy 2671–78, 2004.
- [9] J. Yanik, S. Ebale, A. Kruse, M. Sağlam, M. Yuksel, *Biomass gasification in supercritical water: part I. Effect of the nature of biomass*, Fuel 86, 2410–2415, 2007.
- [10] J. Yanik, S. Ebale, A. Kruse, M. Sağlam, M. Yuksel, *Biomass gasification in supercritical water: II. Effect of catalyst*, International Journal of Hydrogen Energy 33, 4520–4526, 2008.
- [11] Taylor, A.D., Dileo, G.J., Sun. K., 2009, *Hydrogen production and performance of Nickel based catalysts synthesized using supercritical fluids for the gasification of biomass*, Applied Catalysis B Environmental, 93, 126-133, 2009.
- [12] Kıpçak, E., Ö. Söğüt, O., Akgün, M., *Hydrothermal gasification of olive mill wastewater as a biomass source in supercritical water*, J. of Supercritical Fluids, 57, 2011, 50–57.
- [13] F.L. Pacheco, *Supercritical Water Gasification of Biomass*, the Thesis of Doctor of Philosophy, Michigan University, United States, 2009.
- [14] O. Bobleter., *Hydrothermal degradation of polymers derived from plants*, Prog. Polym. Sci, 19, 797-841 pp. 1994.
- [15] D. Selvi Gökkaya , M. Sağlam., M. Yuksel., T. Güngören Madenoğlu, L.Ballice, *Characterization of products evolved from supercritical water gasification of xylose (principal sugar in hemicellulose)*, Biomass and Bioenergy 91 26-36, 2016.
- [16] R. F. Nascimento, J. C. Marques, B. S. L. Neto, D. D. Keukeleire, D. W. Franco, *Qualitative and quantitative high-performance liquid chromatographic analysis of aldehydes in Brazilian sugar can spirits and other distilled alcoholic beverages*, J. Chromatography A 782, 13–23, 1997.
- [17] A.K. Goodwin, G.L. Rorrer, *Reaction rates for supercritical water gasification of xylose in a micro-tubular reactor*, Chemical Engineering Journal, 163, 10–21, 2010.
- [18] F. Resende, S. Fraley, M. Berger, P. Savage, *Noncatalytic gasification of lignin in supercritical water*, Energy and Fuels, 22, 1328–1334, 2008.
- [19] T. Minowa, T. Ogi, S. Yokoyama, *Hydrogen Production from Wet Cellulose by Low-Temperature Gasification Using a Reduced Nickel Catalyst*, Chem. Lett., 937, 1995.

Biohydrogen production from molasses: Effect of photooxidation to molasses

Nevim Genc¹, Ismail Ozbay¹, Elif Durna*¹

Abstract

Hydrogen can be produced through fermenting sugars in a mixed microbial population under anaerobic conditions. In this study, sucrose and the carbohydrate-rich molasses were selected as sugars. Kinetics of hydrogen production from sucrose, untreated and treated molasses in batch cultures was investigated, and the modified Gompertz model was used to describe the hydrogen producing process. The maximum rate of hydrogen production (R_{max} , ml H₂/min) values were 13,55 , 3,68 and 3,23 for sucrose, untreated and treated molasses. Pre-treatment step of photooxidation not affected R_{max} , however lag time decreases from 282 to 213 min. Also, the hydrogen content in the gas increases from 3,5% to 4,5%. Results indicated that effect of pretreatment on biohydrogen production was insignificant. **Keywords:** Dark fermentation, Gompertz equation, Hydrogen production, Molasses, Photooxidation.

1. INTRODUCTION

Among all known alternative energies, hydrogen is considered as a cleanest and suitable fuel with its high calorific value. Hydrogen has been attracting attention as an energy carrier due to its friendliness to environment and the highest gravimetric energy density among various fuels. Hydrogen has 2.4 times the energy content of methane (mass basis) [1]. Currently, hydrogen is commercially produced mainly by energy-intensive processes dependent on fossil fuel. As a sustainable and renewable alternative to these conventional processes, hydrogen production by biological methods provides a cost-effective and clear way [2].

Dark fermentation from the biological hydrogen production processes is more favorable for its independency of light. Process occurs in the absence O₂ as an electron acceptor. The key pathway is the degradation of substrates to H₂ and intermediate products such as volatile fatty acids and alcohols.

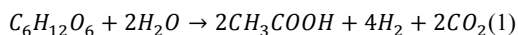

Dark fermentation can be carried out at ambient temperature and pressure conditions, therefore it is known to be less energy-intensive and more environmental friendly. Also, wastes to produce hydrogen are used. So the dark fermentation can serve to purpose such as the utilization of clean energy resources and the disposal of organic wastewaters [3].

The main operational/environmental factors such as organic loading rate (OLR), hydraulic retention time (HRT), hydrogen and CO₂ partial pressure, temperature, pH, alkalinity, nutrients and inhibitors effect fermentative hydrogen production. The effect of each factor on fermentative hydrogen production may vary [4-8].

The first research on biohydrogen production were limited to the use of synthetic substrate, but not economically sustainable. Although in recent reports synthetic medium was used only as nutrient source for improving the hydrogen production activity from various substrates rich in carbohydrates, the practice was still uneconomical for commercialization. Industrial biohydrogen production will have to be carried out under non-sterile conditions using easily available complex substrates with only minimal pretreatment [9].

In addition to various kinds of crops such as sucrose containing biomass, starchy biomass and lignocellulosic biomass, byproducts from biomass processing industries in food sector can be used for hydrogen production. For technical suitability of selected raw materials for hydrogen fermentation was evaluated by four criteria (yield potential, mobilisation efficiency, fermentability, coproduct yield and value), and it was explained by the surface area of the appropriate quadrilateral [10]. Biohydrogen production potential of source such as food and starch-based wastes, cellulosic materials, dairy wastes, palm oil mill effluent and glycerol were discussed [11].

Maximum yield of H₂ for different substrates were 4.24 mol H₂ per mol of sucrose, 2.19 mol H₂ per mol of glucose, 2.09 mol H₂ per mol of fructose, 1.88 mol H₂ per mol of xylose and 0.80 mol H₂ per mol glycerin [12]. So far, the dark fermentation process for hydrogen production has been operated with various types of organic substrates such as

¹ Corresponding author: Kocaeli University, Department of Environmental Engineering, Izmit/Kocaeli, Turkey.
92elifdurna@gmail.com / iozbay@kocaeli.edu.

agricultural waste [13]; sewage sludge [14]; swine wastewater [2]; lignocellulosic biomass [15]; dairy manures [16,17]; molasses [18-20]; cheese whey [21]; sago starch-processing wastewater [22]; molasses with swine manure [9]; sugary wastewater [3]; vinasses [23]; palm oil mill effluent [24]; rice spent wash [25].

Although a few substrates as a carbon source were very efficient for the biohydrogen production, there is still a need to search cheap substrates for industrial application. Molasses contains a high concentration of sugars such as glucose, sucrose and fructose as well as nutrient minerals, therefore it is carbon and nutrient source for biohydrogen production [3].

The purpose of this study was to evaluate the potential use of sucrose and molasses for biohydrogen production at batch reactor. For molasses, improvement in biohydrogen productibility as a result of photooxidation was also evaluated. Anaerobic hydrogen production by mixed cultures was described by the modified Gompertz equation for all substrates.

1.1. Gompertz Equation in Biohydrogen Studies

Kinetic models could be used to describe relationship among the process variables and to quantitatively express the behaviour of fermentation. In addition, useful information for the analysis, design and operation of a fermentation process can be obtain by kinetic models [26].

To describe biohydrogen production, Gompertz equation was used in numerous research. In this experimental approach, three model parameters lag time, H₂ production potential, and H₂ production rate are adjusted to fit the Gompertz equation to experimentally measured hydrogen production data. Although this curve-fitting approach allows high correlation coefficients between the observed and fitted hydrogen generation data, the three model parameters determined by curve-fitting are restricted to specific experimental conditions and can not be used in a predictive mode. Gompertz equation can not account for any of the relevant process variables for predictive purposes [27]. The Gompertz equation was able to adequately describe the formation of various fermentation products [26].

The hydrogen production could be expressed by the modified Gompertz equation [1,17]:

$$H = H_{max} \cdot \exp \left\{ -\exp \left[\frac{R_{max,H_2}}{H_{max}} (\lambda - t) + 1 \right] \right\} \quad (2)$$

where H is the cumulative hydrogen (mL), H_{max} is the maximum cumulative hydrogen (mL), rH₂ is the hydrogen production rate (mL/min), R_{maxH₂} is the maximum rate of hydrogen production (mL/min), λ is the lag time (min) and t is the fermentation time (min).

By differentiating Eq (2), the hydrogen production rate was described as:

$$r_{H_2} = R_{max,H_2} \cdot \exp \left\{ -\exp \left[\frac{R_{max,H_2} \cdot e}{H_{max}} (\lambda - t) + 1 \right] + \left[\frac{R_{max,H_2} \cdot e}{H_{max}} (\lambda - t) + 1 \right] + 1 \right\} \quad (3)$$

2. MATERIALS AND METHODS

2.1. Feeding

The molassees used as substrate for hydrogen production, minimum 45% (w/w) of molasses corresponded to readily fermentative sugars, was obtained from local sugar refining industry. In experiment, the molasses was used after diluted by water to a certain concentration. In sucrose experiment, the feed to the reactor was composed as follows: 10 g/L sucrose, 1.5 g/L KH₂PO₄, 3.2 g/L Na₂HPO₄·7H₂O, 0.5 g/L NH₄Cl, 0.18 g/L MgCl₂·6H₂O, 1.0 g/L yeast excreat, 0.5 g/L meat excreat, 0.5 g/L peptone [28].

2.2. Seed Sludge and Pretreatment Methods

The anaerobic sludge used as seed was collected from Anaerobic Wastewater Treatment Plants (at acidification phase) of PAKMAYA which produces yeast from molasses (Kocaeli/Turkey). The total solid content of the sludge was 27510 mg/L (in dry weight). The volatile suspended solid (VSS) concentration of the sludge was 10600 mg/L. To inhibit the activity of hydrogen consumers and to harvest hydrogen-producing anaerobes, pretreatment was applied to sludge [29]. The pretreatment of the seed sludge was carried out by heating the sludge at 100 °C for 60 min. The seed sludge used without acclimated with substrate.

2.3. Pretreatment Methods of Molasses

In the experimental work, molasses diluted with distilled water was used. COD of diluted molasses is 22150 mg/L. Experiments were performed in an open batch system. Photooxidation of molasses was carried out by illumination of molasses. An aliquot of 500 mL molasses solution was placed in a 1L beaker with the 0.2 g/L of TiO₂ was stirred magnetic stirrer at room temperature. UV lamp with power of 125 W (HPR 125 W HG Philips) was used as the light source. Relative spectral power distribution of lamp is in the wavelength range of 300-700 nm. Luminous flux and

luminous efficacy of lamp are 2900 lm and 23.2 lm W⁻¹, respectively. The mixture of molasses with TiO₂ was stirred for 60 min. Photocatalyzed molasses solution was used in dark fermentation after TiO₂ separation.

2.4. Biohydrogen Batch Fermentation Test

The batch experiments were performed in a 7L bioreactor equipped with an ADI 1030 system controller and BioXpert 2 data-acquisition software (Applikon Biotechnology, The Netherlands). The batch reactor filled with 3.3L mixtures, comprising the inoculum (0.3L) and the substrate solution (3L). Meanwhile, there is no nutrient solution added to molasse into the batch reactors, whereas nutrient solution is added to sucrose. pH was monitored online (AppliSens, The Netherlands) pH values of mixtures was adjusted to 7.0 with HCl and NaOH solution with a peristaltic pump during fermentation. Reactor was flushed with nitrogen gas to remove oxygen and to create an anaerobic environment. At each time period, the biogas produced was instantly released from the headspace, creating no overpressure and continuously measured by a flow meter appropriate (Bronkhorst) for small volumes after cooling. Temperature in the reactor was controlled by a platinum probe Pt100. Temperature was automatically maintained at the level of 37 °C using an electric jacket, and was recorded on-line. Stirring velocity was maintained at 150 rpm. Mixing was performed with two Rushton turbines. Additional sensor was connected to the reactor for measuring the redox potential. The transmitter for oxidation reduction potential (ORP) was connected to a computer for on-line data acquisition. Nitrogen was used as carrier gas with a flow-rate of 100mL/min to carry to H₂ analyzer of biogas. Also, ORP reduced by nitrogen flow in fermentation processes.

2.5. Analysis

COD and VSS were measured according to standard methods [30]. The H₂ content of the biogas was monitored on-line with a H₂ sensor (BCP-H2, BlueSens).

3. RESULT AND DISCUSSION

Although food waste offers high hydrogen production potential, the performances of the biohydrogen production processes are related not only to the operating conditions, but also, to the compound of the organic waste [13].

The molasses fermentation wastewater contains colored substances such as melanin derivatives, Maillard pigment, and caramel, as well as large amounts of carbonate and phosphate. It is difficult to destroy many of these compounds by biochemical and physico-chemical methods. In addition, traditional biochemical and physico-chemical treatment methods are inadequate as these kinds of pigments are heat and light resistant, and can not be decolorized easily [31].

The cheap and efficient pretreatment method must convert the complex substrate to product that it should not inhibit microbiological activity and it must contain a high concentration of readily fermentable compounds. In general, pretreatment methods of biomass can be divided into three main types: mechanical, physicochemical and biological. During physicochemical pretreatment, substrate is exposed to acidic, alkaline or oxidative conditions at ambient or elevated temperature [32].

In the present study, hydrogen productivity of sucrose, untreated and treated molasses as a carbon source were investigated. The kinetics of hydrogen production were taken into consideration. Cumulative hydrogen production is shown in Fig.1. As shown in Fig. 1, the hydrogen production increased with fermentation time. Biodegradability of substrate may influence the lag phase and the rate of hydrogen production in batch substrate-to-hydrogen tests. In a batch test, H increases very slowly with increasing fermentation time from 0 to λ , and then increases rapidly almost at the rate of R_{max} and finally reaches an asymptotic value H_{max} with further increasing the fermentation time. The experimental data were regressed with Eq. (2). High correlation coefficient values suggest that Eq. (2) was able to accurately describe the hydrogen production from sucrose and molasses by mixed cultures. The estimated parameters were given in Table 1. High degradability of sucrose causes short lag time of about 233 min. Lag time of untreated molasses decreases from 282 to 213 min by pre-treatment step of photooxidation. Pre-treatment step decreases lag time, however, it not affected maximum cumulative hydrogen and rate of hydrogen production. Highest maximum cumulative hydrogen and rate of hydrogen production were observed for sucrose among substrate (Table 1). Because sucrose could be more easily degrade by used bacterial seeds. The hydrogen content in the gas phase is given Figure 2. Highest H₂ concentration for sucrose, untreated and treated molasses experiments were 17.8% at 328 min, 3.5% at 530 min, and 4.5% at 506 min, respectively. Experimental results indicated that the photooxidation pre-treatment of molasses had insignificant influence on biohydrogen production.

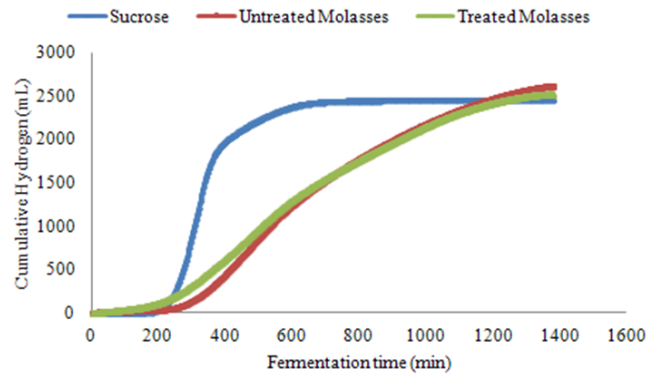

Figure 1. Cumulative hydrogen production during dark fermentation

Table 1. Kinetic parameters determined using modified Gompertz equation

Substrate	H _{max} (mL)	R _{max} (mL H ₂ /min)	λ (min)	R ²
Sucrose	2442	13.55	233	0.996836
Untreated Molasses	2687	3.67	536	0.997898
Treated Molasses	2676	3.00	410	0.998773

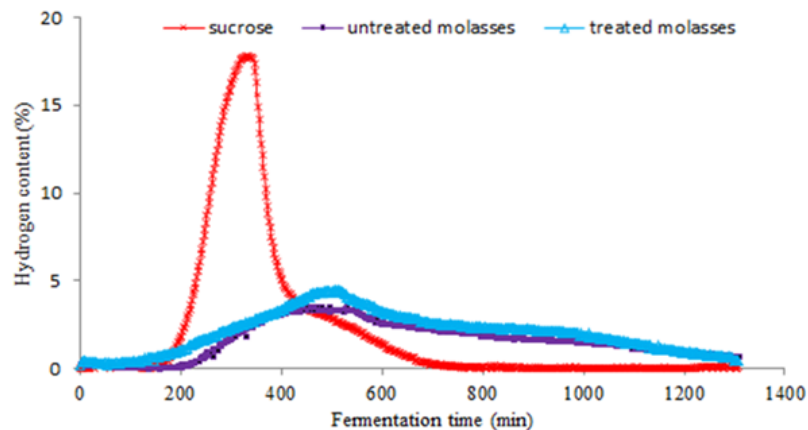

Figure 2. Hydrogen content of biogas produced by dark fermentation

Significant differences between the untreated and treated molasses results are not observed. These cases might be due to unimproved biodegradability of molasses by pre-treatment step. COD removal during fermentation of untreated and treated molasses were 30% and 37%, respectively. The analysis of hydrogen production from molasses by Buitron and Carvajal indicated that molasses strongly inhibited the biomass. Also, it is possible that melanoidins in molasses caused toxic effects. To enhance energy recovery, the sequent anaerobic fermentation process for coproduction of hydrogen and methane has attracting attention [23].

Hydrogen production rate is shown in Fig.3. As illustrated in Fig. 3, the hydrogen production rate calculated from Eq. (3) peaked at 13.5 mL/min after 296 min fermentation for sucrose, 3.67mL/min after 536 min fermentation for

untreated molasses, 3.00 mL/min after 410 min fermentation for treated molasses. In sucrose, untreated and treated molasses tests, after H₂ productivity reached its maximum value, it rapidly decreased. It can be seen that Cappelletti et al., Frascari et al., obtained the maximum hydrogen production rate of 0.028 mmol /L min, 0.021 mmol/L min using molasses as substrate, respectively [20, 33]. As a relative low hydrogen production rate of 0.046 and 0.038 mmol/L min for untreated and treated molasses, respectively was achieved in this study. The hydrogen conversion efficiency of sucrose and molasses were obtained as 23 and 15% by Logan et al., The reason of lower gas production of molasses could be due to the degradative capabilities of the inoculum [34].

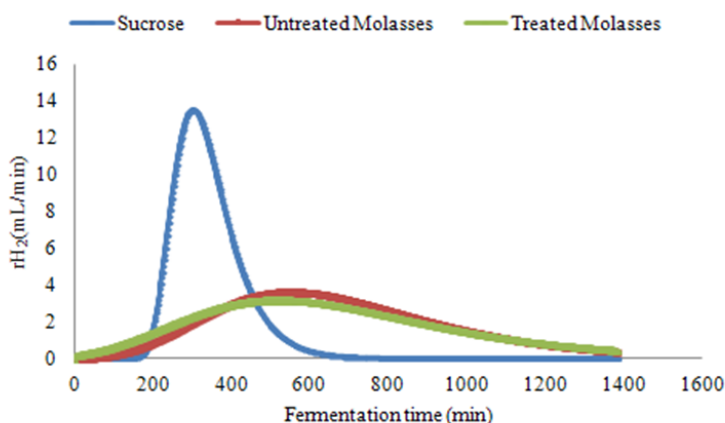

Figure 3. Hydrogen production rate during dark fermentation

Drawback of fermentative biohydrogen processes is that it uses mono- and disaccharides for substrates. If hydrogen is to be produced, carbohydrate availability to the hydrogen producing organisms must be improved. Photooxidation processes aim to increase the solubility of carbohydrate in molasses. Severe conditions are not tested due to high catalyst amount and irradiation time increase the pretreatment costs. In this study, therefore photooxidation conditions applied to molasses were ineffective in improving of the biohydrogen production.

4. CONCLUSION

Kinetics of hydrogen production from sucrose, untreated and treated molasses in batch cultures was investigated, and the modified Gompertz model was used to describe the hydrogen producing process. Based on the experiment results, following conclusions can be drawn:

Experimental results show that the hydrogen production rate can vary depending on the composition of waste used as substrate. The maximum hydrogen production rate was found as 13.5 mL H₂/min at about 296 min of inoculation in case of sucrose, as 3.67 mL/min at about 536 min in the case of untreated molasses, and as 3.00 mL H₂/min at about 410 min. Significant differences between the untreated and treated molasses results are not observed. These results can be explained with the unimproved biodegradability of molasses by pre-treatment step.

To enhance the commercial viability of biohydrogen production, the carbohydrate-rich molasses selected as feedstock instead of some pure chemicals contributes significantly to the cost reduction. But, non-reducing sugars must be broken by cheap and effective pretreatment methods.

ACKNOWLEDGMENT

This work was financially supported by the Scientific Research Projects Administration of Kocaeli University (2012/054).

REFERENCES

- [1] Y. Mu, H.Q. Yu, and G. Wang, "A kinetic approach to anaerobic hydrogen-producing process", *Water Research*, vol. 41, pp. 1152-1160, 2007.
- [2] Y. Li, J. Zhu, X. Wu, C. Miller, and L. Wang, "The effect of pH on continuous biohydrogen production from swine wastewater supplemented with glucose", *Appl. Biochem. Biotech.*, vol. 162, pp. 1286-1296, 2010.
- [3] B. Wang, Y. Li, D. Wang, R. Liu, Z. Wei, and N. Ren, "Simultaneous coproduction of hydrogen and methane from sugary wastewater by an "ACSTRH-UASBMet" system", *Int. J. Hydrogen Energy*, vol. 38, pp. 7774-7779, 2013.
- [4] P. Mohammadi, S. Ibrahim, M.S.M. Annuar, S. Ghafari, S. Vikineswary, and A.A. Zinatizadeh, "Influences of environmental and operational factors on dark fermentative hydrogen production: A review", *Clean-Soil, Air, Water*, vol. 40, pp. 1297-1305, 2012.

- [5] J. Wang, and W. Wan, "Factors influencing fermentative hydrogen production: A review", *Int. J. Hydrogen Energy*, vol. 34, pp. 799-811, 2009.
- [6] I.K. Kapdan, and F. Kargi, "Bio-hydrogen production from waste materials", *Enzyme Microb. Tech.*, vol. 38, pp. 569-582, 2006.
- [7] C. Li, and H.H.P. Fang, "Fermentative hydrogen production from wastewater and solid wastes by mixed cultures", *Crit. Rev.in Env. Sci. Tec.*, vol. 37, pp.1-39, 2007.
- [8] N. Khanna, and D.Das, "Biohydrogen production by dark fermentation", *WIREs Energ. Env.*, vol. 2, pp. 401-421, 2013.
- [9] X. Wu, H. Lin, and J. Zhu, "Optimization of continuous hydrogen production from co-fermenting molasses with liquid swine manure in an anaerobic sequencing batch reactor", *Bioresource Technol.*, vol. 136, pp. 351-359, 2013.
- [10] K. Urbaniec, and R.Grabarczyk, "Raw materials for fermentative hydrogen production", *J. Clean. Prod.*, vol. 17, pp. 959-962, 2009.
- [11] M.L. Chong, V. Sabaratnam, Y. Shirai, and M.A. Hassana, "Biohydrogen production from biomass and industrial wastes by dark fermentation", *Int. J. Hydrogen Energy*, vol. 34, pp. 3277-3287, 2009.
- [12] L.R.V.D. Sa, M.C. Cammarota, E.M.M. Oliveira, A. Matos, and V.S.F. Leita, "Pentoses, hexoses and glycerin as substrates for biohydrogen production: An approach for Brazilian biofuel integration", *Int. J. Hydrogen Energy*, vol. 38, pp. 2986-2997, 2013.
- [13] X.M. Guo, E. Trably, E. Latrille, H. Carrere, and J.P. Steyer, "Hydrogen production from agricultural waste by dark fermentation: A review", *Int. J. Hydrogen Energy*, vol. 35, pp. 10660-10673, 2010.
- [14] J.H. Woo, and Y.C. Song, "Biohydrogen production from sewage sludge using a continuous hydrogen fermentation system with a heat treatment vessel", *KSCE J. Civ. Eng.*, vol. 14, pp. 673-679, 2010.
- [15] B. Ren, A. Wang, G. Cao, J. Xu, and L. Gao, "Bioconversion of lignocellulosic biomass to hydrogen: Potential and challenges", *Biotechnol. Adv.*, vol. 27, pp. 1051-1060, 2009.
- [16] S.V. Mohan, V.L. Babu, and P.N. Sarma, "Effect of various pretreatment methods on anaerobic mixed microflora to enhance biohydrogen production utilizing dairy wastewater as substrate", *Bioresource Technol.*, vol. 99, pp. 59-67, 2008.
- [17] Y. Xing, Z. Li, Y. Fan, and H. Hou, "Biohydrogen production from dairy manures with acidification pretreatment by anaerobic fermentation", *Environ. Sci. Pollut. R.*, vol. 17, pp. 392-399, 2010.
- [18] N. Ren, J. Li, B. Li, Y. Wang, and S. Liu, "Biohydrogen production from molasses by anaerobic fermentation with a pilot-scale bioreactor system", *Int. J. Hydrogen Energy*, vol. 15, pp. 2147-2157, 2006.
- [19] C. Aceves-Lara, E. Latrille, N. Bernet, P. Buffiere, and J. Steyer, "A pseudo-stoichiometric dynamic model of anaerobic hydrogen production from molasses", *Water Res.*, vol.42, pp. 2539-2550, 2008.
- [20] D. Frascari, M. Cappelletti, J.D.S. Mendes, A. Alberini, F. Scimonelli, C. Manfreda, L. Longanesi, D. Zannoni, D. Pinelli, and S. Fedi, "A kinetic study of biohydrogen production from glucose, molasses and cheese whey by suspended and attached cells of *Thermotoga neapolitana*", *Bioresource Technol.*, vol. 147, pp. 553-561, 2013.
- [21] N. Azbar, F.T.Ç. Dokgöz, T. Keskin, K.S. Korkmaz, and H.M. Syed, "Continuous fermentative hydrogen production from cheese whey wastewater under thermophilic anaerobic conditions", *Int. J. Hydrogen Energy*, vol. 34, pp. 7441-7447, 2009.
- [22] B. Sen, and R.R. Suttar, "Mesophilic fermentative hydrogen production from sagostarch-processing wastewater using enriched mixed cultures", *Int. J. Hydrogen Energy*, vol. 37, pp. 15588-15597, 2012.
- [23] G. Buitron, and C. Carvajal, "Biohydrogen production from Tequila vinasses in an anaerobic sequencing batch reactor: Effect of initial substrate concentration, temperature and hydraulic retention time", *Bioresource Technol.*, vol. 101, pp. 9071-9077, 2010.
- [24] P. Mohammadi, S. Ibrahim, M.S.M.A. Annuar, and S. Law, "Effects of different pretreatment methods on anaerobic mixed microflora for hydrogen production and COD reduction from palm oil mill effluent", *J. Clean. Prod.*, vol. 19, pp. 1654-1658, 2011.
- [25] S. Roy, S. Ghosh, and D. Das, "Improvement of hydrogen production with thermophilic mixed culture from rice spent wash of distillery industry", *Int. J. Hydrogen Energy*, vol. 37, pp. 15867-15874, 2012.
- [26] Y. Mu, G. Wang, and H.Q. Yu, "Kinetic modeling of batch hydrogen production process by mixed anaerobic cultures", *Bioresource Technol.*, vol. 97, pp. 1302-1307, 2006.
- [27] V. Gadhamshetty, Y. Arudchelvam, N. Nirmalakhandan, and D.C. Johnson, "Modeling dark fermentation for biohydrogen production: ADM1-based model vs. Gompertz model", *Int. J. Hydrogen Energy*, vol. 35, pp. 479-490, 2010.
- [28] H. Zhu, and M. Beland, "Evaluation of alternative methods of preparing hydrogen producing seeds from digested wastewater sludge", *Int. J. Hydrogen Energy*, vol. 31, pp. 1980-1988, 2006.
- [29] Y. Yin, J. Hu, J. Wang, "Enriching hydrogen-producing bacteria from digested sludge by different pretreatment methods", *International Journal of Hydrogen Energy*, vol. 39, 13550-13556, 2014.
- [30] APHA, *Standard methods for the examination of water and wastewater*, 20 th ed. American Public Health Association, Washington, DC, 1998.
- [31] M. Fan, Z. Qin, Z. Liu, T. Su, "Preparation of Bi_xY_(2-x)O₃ and its Photocatalytic Degradation of Molasses Fermentation Wastewater under Visible-light Irradiation", *Advanced Materials Research*, vols. 287-290, 1640-1645, 2011.
- [32] I. Ntaikou, G. Antonopoulou, G. Lyberatos, "Biohydrogen Production from Biomass and Wastes via Dark Fermentation: A Review", *Waste Biomass Valor.*, vol. 1, 21-39, 2010.
- [33] M. Cappelletti, G. Bucchi, J.D.S. Mendes, A. Alberini, S. Fedi, L. Bertin, and D. Frascari, "Biohydrogen production from glucose, molasses and cheese whey by suspended and attached cells of four hyperthermophilic *Thermotoga* strains", *J. Chem. Technol. Biot.*, vol. 87, pp. 1291-1301, 2012.
- [34] B.E. Logan, S.E. Oh, I.S. Kim, S.V. Ginkel, "Biological Hydrogen Production Measured in Batch Anaerobic Respirometers", *Environ. Sci. Technol.*, vol 36, pp. 2530-2535, 2002.

Outdoor Air Pollution Increased with Urban Transformation in Istanbul Anatolian Side

Esin Bozkurt¹, Gussun Gunes¹*

Abstract

Urban transformation has important impacts on degradation of air quality, while providing the urban growth. Deterioration of air quality not only affects human health but also changes to whole surrounded ecosystems. Many air pollutants are responsible for the degradation of outdoor air quality. Major air pollutants are gasses, chemicals and particulate matters that comes from the burning of fossil fuels. Efforts to improve air quality and reduction of air pollution are important to protect public health. From Marmara Clean Air Centre in Istanbul, air quality parameters affected by urban transformation are evaluated in this study. Measurement values in Istanbul are investigated comparing with threshold limit values of Turkey and World. In 2013 and 2014, PM₁₀, PM_{2.5}, SO₂, NO₂ outdoor values in Uskudar and Umraniye are analyzed especially related to growing impacts of urban transformation on the Anatolian side. Data over the period March 1, 2013 - December 1, 2014 is analyzed related to public health. Suggestions are made for improving air quality. If people aware that quality of air in their space affects their health, they can prevent pollution by saving energy, reducing the air pollution of their cars, recycling etc..

Keywords: NO₂, Outdoor Air Quality, Particulate matter, SO₂

1. INTRODUCTION

Air pollution has become a major health problem with the industrial revolution. In the early twenty century, amount of sulfur dioxide and particulate matter in the air was increased as a result of excessive use of fossil fuels. Therefore increase in mortality due to respiratory disease was observed [1]. Acute outdoor particulate matter 10 (PM₁₀) pollution may also associate with mortality [2]. A study between 1989 and 1991 in Chile has shown strong association between PM₁₀ exposure and mortality after multiple regression analysis. A change equal to 10-microgram-per-cubic-meter in daily PM₁₀ was associated with 1% increase in mortality [3]. Heart disease, disease from stroke, respiratory disease, and lung cancer may be less if air pollution level is less. NO₂ pollutes the air mainly as a result of road traffic and energy production. Rising levels of nitrogen dioxide (NO₂) may increase the risk of death in patients with asthma [4]. Air pollution effects person's productivity [5]. According to Akdur's concern in local new media, air pollution directly affect the public health and can cause mass deaths [6]. A massive traffic jam in Pekin, China stretching for 100km near Beijing could lasted for ten days in August 2010. Chemical reaction caused acid rain begins when compounds like sulfur dioxide (SO₂) and NO₂ are released into air. As far as scholar are concerned, PM₁₀ level in Istanbul is high because of exhaust gases and urban transformation. In 2014, most polluted districts in Istanbul were Esenyurt, Sirinevler, Basaksehir, and Umraniye. According to Pala, measurement of these stations in Istanbul showed that PM₁₀ levels were over limit in 2014 [7]. There was no limit value for particulate matter 2.5 (PM_{2.5}) in Turkish Standards.

2. STUDY AREAS

¹ Corresponding author: Marmara University, Department of Environmental Engineering, 34722, Kadikoy/Istanbul, Turkey.
esin.bozkurt@marmara.edu.tr, gussun.gunes@marmara.edu.tr

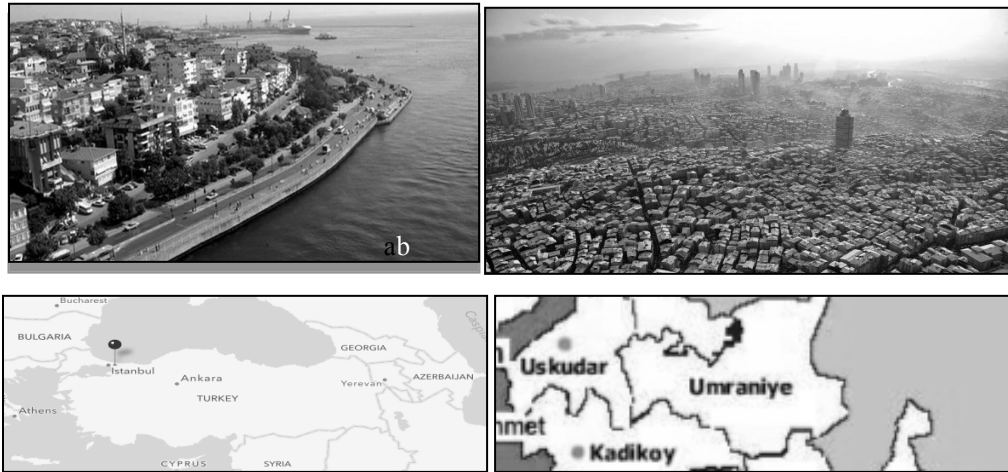

Figure 1. Study areas: (a) Uskudar and (b) Umraniye in (d) Istanbul, (c) Turkey

PM₁₀, PM_{2.5}, SO₂, NO₂ outdoor data in Uskudar and Umraniye over the period March 1, 2013 - December 1, 2014 is collected by Marmara Clean Air Centre in Istanbul, Turkey as shown in Figure 1.

3. MEASUREMENT METHODS

PM₁₀ and PM_{2.5} : TS ISO 10473 : Ambient air quality- Measurement of mass particulate substance collected in a filter - Beta Ray Absorption Method

SO₂ : TS EN 14212 : Ambient air quality - Measurement method for the determination of the sulfur dioxide by ultraviolet fluorescence

NO₂ : EN 14211 : Ambient air quality – Concentration of nitrogen dioxide was determined by measuring the intensity of chemiluminescence.

4. RESULTS

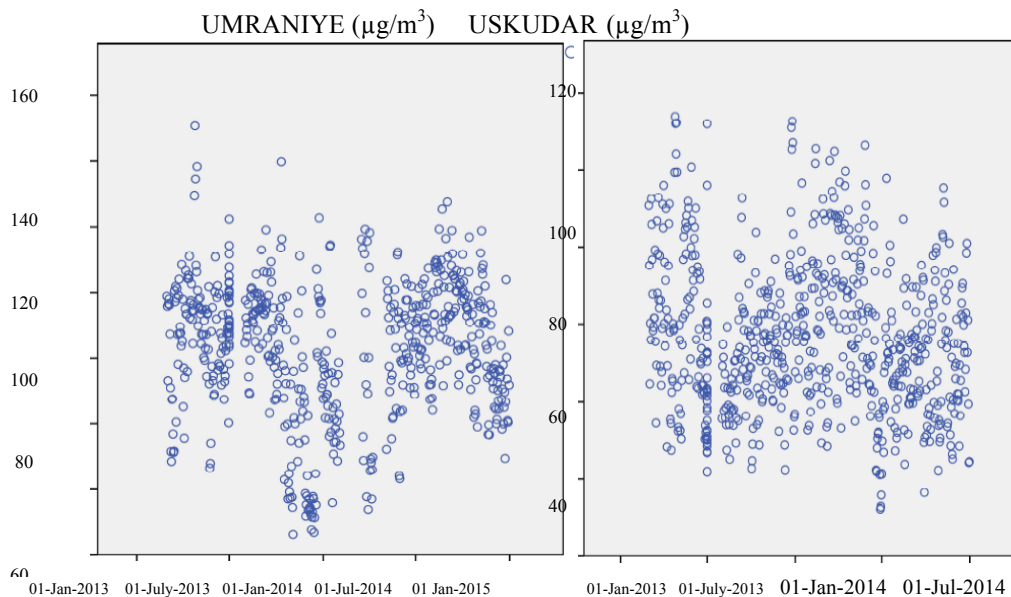

Figure 4. Nitrogen dioxide data

NO₂ data in Uskudar and Umraniye is shown in Figure 2.

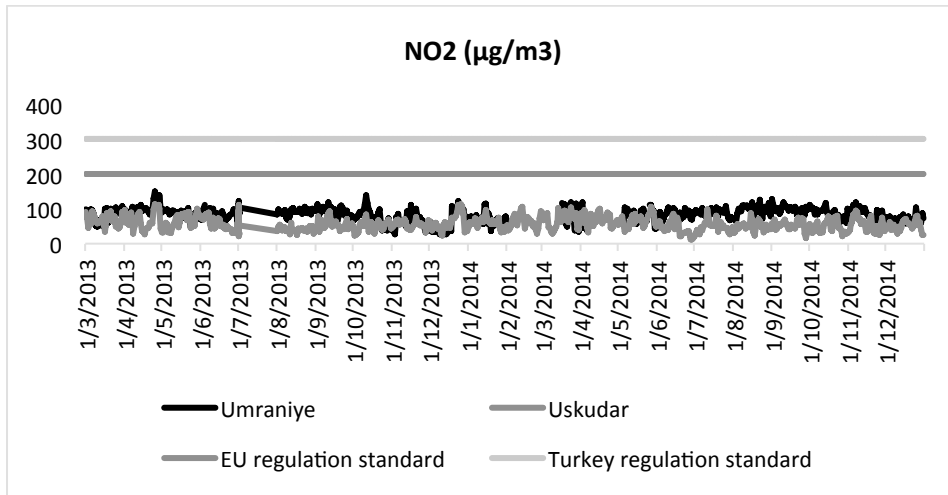

Figure 3. Nitrogen dioxide relative to the Turkish and EU guidelines

The highest NO₂ concentrations in Umraniye and Uskudar are 151µg/m³ and 114µg/m³. On the other hand, the lowest concentrations were 26µg/m³ in Umraniye and 12µg/m³ in Uskudar. When NO₂ concentrations in Umraniye and Uskudar compared with Turkish and EU standards, they were within allowable limits as shown in Figure 3.

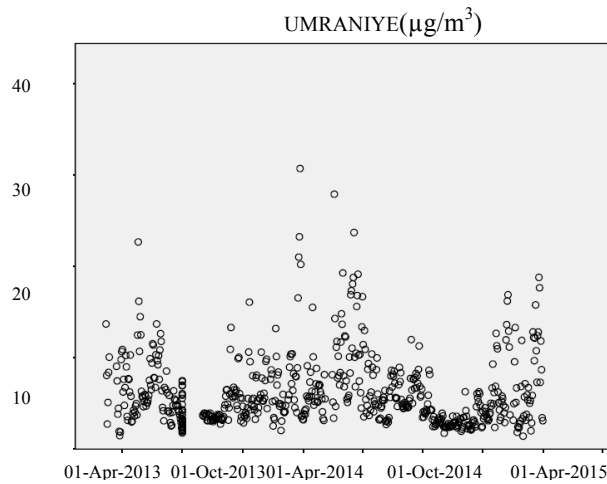

Figure 4. Sulfur dioxide data

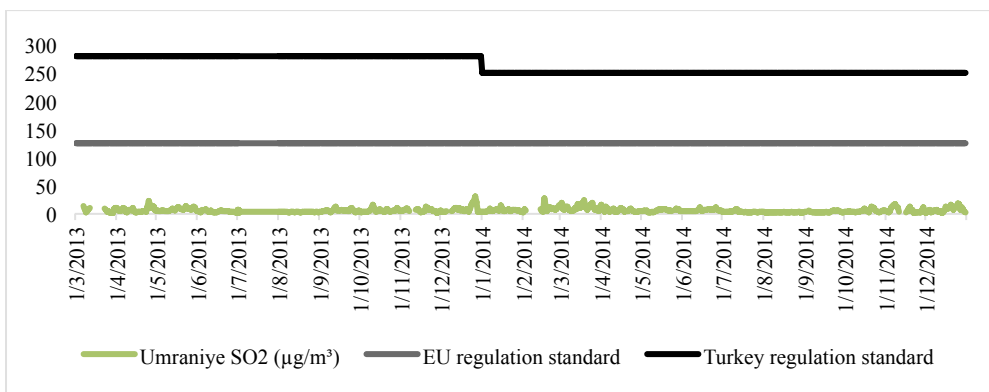

Figure 5. Sulfur dioxide relative to the Turkish and EU guidelines

None of the sulfur dioxide concentrations between 2013 and 2014 in Umraniye exceeded the Turkish or EU standards as shown in Figure 4,5. Actually, the highest and lowest SO₂ concentrations in Umraniye are respectively 31µg/m³ and 1µg/m³. Maximum allowed SO₂ concentrations approved by Turkish Law are 280µg/m³ in 2013 and 250µg/m³ in 2014. Besides maximum allowed SO₂ concentration approved by EU Law is 125µg/m³.

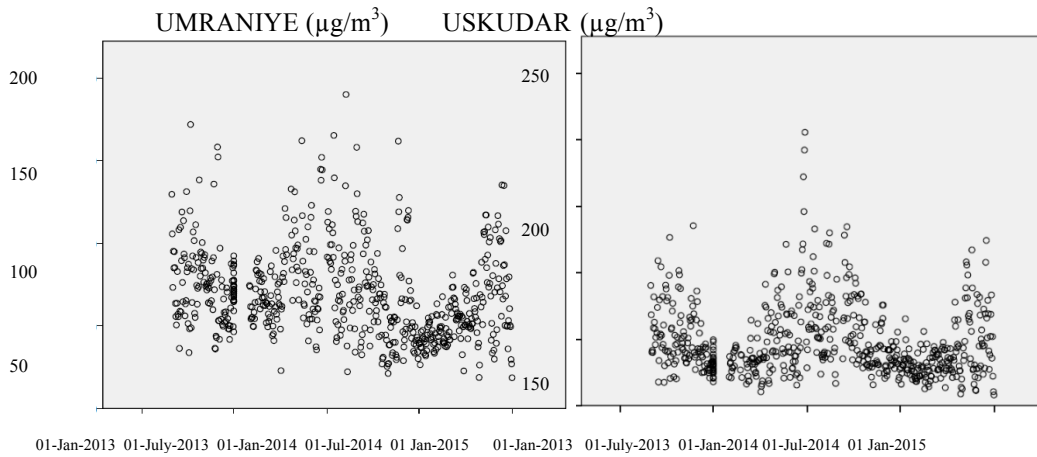

Figure 6. Particulate matter 10 data

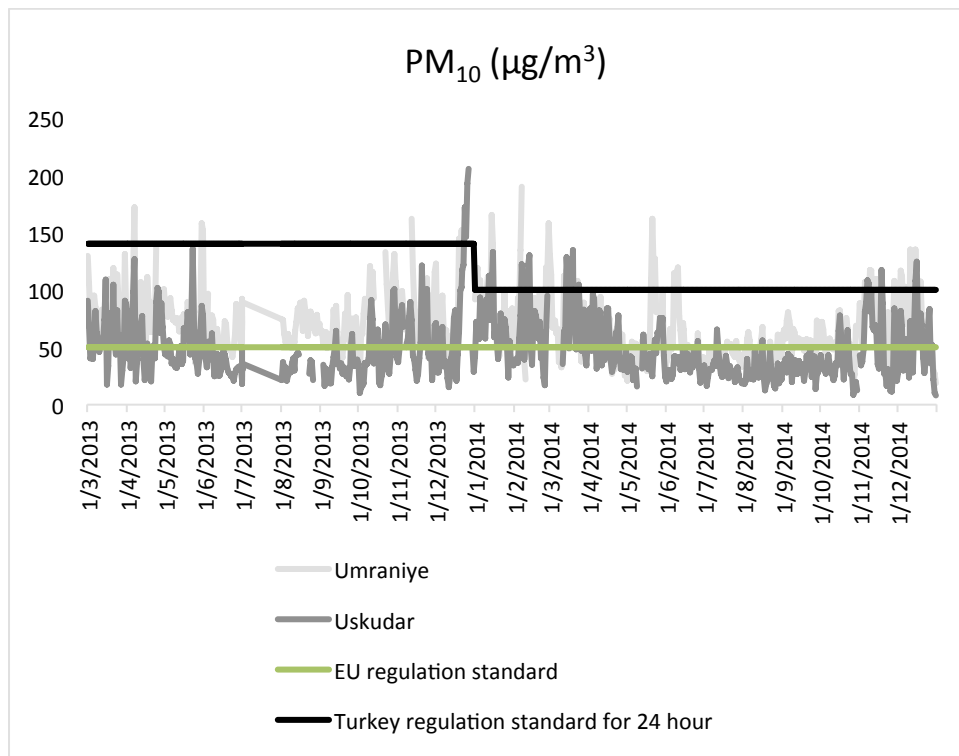

Figure 7. Particulate matter 10 relative to the Turkish and EU guidelines

Comparison of results showed that some of the PM_{10} concentrations exceeded the Turkish and EU standards as shown in Figure 6,7. Indeed, the highest PM_{10} concentrations between 2013 and 2014 in Umraniye and Uskudar were respectively $189.9\mu\text{g}/\text{m}^3$ and $205.6\mu\text{g}/\text{m}^3$. Furthermore, the lowest PM_{10} concentrations in Umraniye and Uskudar are observed respectively $18.5\mu\text{g}/\text{m}^3$ and $8\mu\text{g}/\text{m}^3$. Maximum allowed PM_{10} values approved by Turkish Law are $140\mu\text{g}/\text{m}^3$ in 2013 and $100\mu\text{g}/\text{m}^3$ in 2014. In addition, maximum allowed PM_{10} value approved by EU Law is $50\mu\text{g}/\text{m}^3$. PM_{10} pollution hovered at unhealthy levels especially in winter.

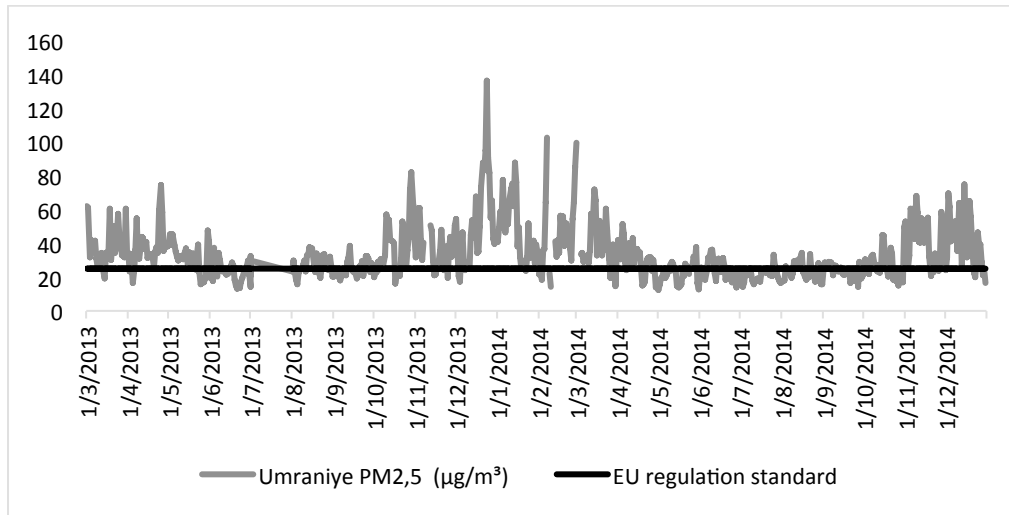

Figure 8. Particulate matter 2.5 relative to the EU guideline

The highest and lowest PM_{2,5} concentrations in Umraniye are respectively 136µg/m³ and 12µg/m³ as illustrated in Figure 8. There is not limit value for PM_{2,5} in Turkish Law. Besides, maximum allowed PM_{2,5} value approved by EU Law is 25µg/m³.

Table 3. Death cause's rates in Istanbul and Turkey [8]

Usual residence	Year	Total	Cause of death						
			Diseases of the circulatory system	Neoplasms	Diseases of the respiratory system	Endocrine, nutritional and metabolic diseases	External causes of injury and poisoning	Diseases of the nervous system and the sense organs	Other
Turkey	2013	360 873	143 084	76 534	35 364	20 095	20 409	14 708	50 679
Istanbul	2013	52 449	19 382	13 336	5 423	2 555	1 955	2 449	7 349
Turkey	2014	375 291	151 696	77 587	40 258	19 288	16 018	16 517	53 927
Istanbul	2014	53 854	19 955	13 432	6 067	2 681	1 061	2 836	7 822

Number of circulatory system diseases-related deaths in 2013 was 19.382 in Istanbul and 14.3084 in Turkey. In 2014 this was 19.955 in Istanbul and 151.696 in Turkey (Table 1).

Number of respiratory system diseases-related deaths in 2013 was 5.423 in Istanbul and 35.364 in Turkey. In 2014 this was 6.067 in Istanbul and 40.258 in Turkey.

Ratio of circulatory system diseases was 39.6% in 2013 and 40.4% in 2014. Ratio of respiratory system diseases was 9.8% in 2013 and 10.7% in 2014.

5. CONCLUSIONS

Outdoor air quality affects the public health so emission control and monitoring are important. The Marmara Clean Air Centre in Istanbul has air quality monitoring stations. In this study, measurement values of NO₂, SO₂, PM₁₀ and PM_{2,5} from this center were investigated. Threshold limit values (TLV) that the Ministry of Environment and Urbanisation and European legislation sets on air pollution were compared with measured values between March 1, 2013 and December 1, 2014 in Umraniye and Uskudar. Moreover EU limit concentrations of air quality parameters were compared with measured values. Concentrations of SO₂ in Umraniye belowed threshold limit values so health effects did not occur. NO₂ findings also indicated that there was no significant threat to human health from these gasses in Umraniye and Uskudar. Nevertheless, air pollution because of PM₁₀ in Umraniye and Uskudar adversely must have affected health and environment especially in winter. PM₁₀ pollution can cause respiratory, cardiovascular diseases, asthma attacks, and lung cancer. Hence air pollution endangered particularly vulnerable groups such as children, elderly and those with low immunity. To date, there is little published information about the air quality of Istanbul. Therefore, we emphasize the importance of raising public awareness that could effectively reduce air pollution by energy saving or reducing fossil fuel use. Government's measures like clean technology, effective public

transport are also important to prevent the inadequacy of the outdoor air quality. Press and broadcast media can be an effective way to warn people when air pollution occurs.

ACKNOWLEDGMENT

The Study data was supported by Marmara Clean Air Centre in Ministry of Environment and Urban Planning. This study was supported by Marmara University, Engineering Department No: 1600242456 September 08, 2016.

REFERENCES

- [1] C. Rusznak, H. Bayram, J.L. Devalia, R.J. Davies, "Impact of the environment on allergic lung diseases", *Clin Exp Allergy*, vol. 27, pp. 26-35, 1997.
- [2] G. D. Thurston, "A critical review of PM10-mortality time-series studies.", *Journal of exposure analysis and environmental epidemiology*, vol. 6, pp. 3-21, 1995.
- [3] Ostro, B., Sanchez, J. M., Aranda, C., & Eskeland, G. S. (1995). Air pollution and mortality: results from a study of Santiago, Chile. *Journal of exposure analysis and environmental epidemiology*, 6(1), 97-114.
- [4] J. Sunyer, X. Basagana, J. Belmonte, & J. M. Anto, "Effect of nitrogen dioxide and ozone on the risk of dying in patients with severe asthma", *Thorax*, vol. 57, pp. 687-693, 2002.
- [5] A. Lichter, N. Pestel, E. Sommer. *Productivity Effects of Air Pollution: Evidence from Professional Soccer*, IZA Discussion Papers 8964, Institute for the Study of Labor (IZA), 2015.
- [6] (2014) Cumhuriyet newspaper website. [Online]. Available: http://www.cumhuriyet.com.tr/haber/cevre/166723/Turkiye_icin_felaket_uyarisi_Toplu_olumler_olabilir.html
- [7] (2015) Ulusalkanal website. [Online]. Available: <http://ulusalkanal.com.tr/m/?id=85021>
- [8] (2016) TurkStat, Causes of Death Statistics, 2013 and 2014. [Online]. Available: <http://www.tuik.gov.tr/PreHaberBultenleri.do?id=18855>

Effects Of Using Pure Eco-Friendly Lubricants In Pump Bearings Instead Of Traditional Mineral Lubricants

Fatih Dokme¹, Muzaffer Turan¹

Abstract

Green manufacturing, green maintenance is a must for sustainable future. Pumping systems account for nearly 20% of the world's electrical energy, therefore pumps are one of the most important equipment for industry, agriculture and municipality. Every operating equipment have potential for environment pollution cause during operation and maintenance. In pumping systems, lubricants have potential of soil and water pollution in case of possible leakages. Therefore using ecofriendly lubricants in pumping systems could be a good prevention for sustainable future.

Pumps bearings need to be lubricated as any rotating equipment, and for this purpose they have an oil sump for lubricant filling. Usually mineral or synthetic oil are used for bearing lubrication. In case of oil leakage in sealing system of pump; soil or water could contaminated with oil. In last decades ecofriendly lubricants have enlarged usage area because of their excellent lubricity, biodegradability, good viscosity-temperature characteristics, and low evaporation loss. This study focused on the effects of using ecofriendly pure vegetable based lubricants instead of mineral oil in pumping system bearings. Although vegetable based oils have good tribological properties, nowadays it is studied on additives to improve their thermal susceptibilities. But nowadays they are not commercial. So in this study commercially pure canola and soy bean oil was experimented with traditional mineral oil and bearing damage and failure analysis was compared for each lubricants. This study aims to reduce the contamination of water and soil by pump lubrication system leakages.

Keywords: Pump, Eco-Friendly, Lubricant, Bearing

1. INTRODUCTION

Since human existence years ecological and environmental balance disrupts. In recent years this balance become increasingly important as a part of sustainable future. Green manufacturing is a method for manufacturing minimize wastes and pollutions at sources. Green manufacturing also can lead to lower raw material costs (e.g., recycling wastes rather than purchasing virgin materials), production efficiency gains (e.g., less energy and water usage), reduced environmental and occupational safety expenses (e.g., smaller regulatory compliance costs and potential liabilities), and improved corporate image (e.g., decreasing perceived environmental impacts on the public) [1].

The green manufacturing process cycle is shown in Fig. 1, and it can be seen that the process begins with design, followed by procurement, raw material extraction, manufacturing, distribution, purchasing, customer use and maintenance, disposal and recycling [2]. This study focused on the step of use and maintenance of this cycle.

¹ Corresponding author: Siseecam Chemicals Group, Soda Sanayii A.S., 33003, Akdeniz/Mersin., Turkey. fdokme@seicam.com

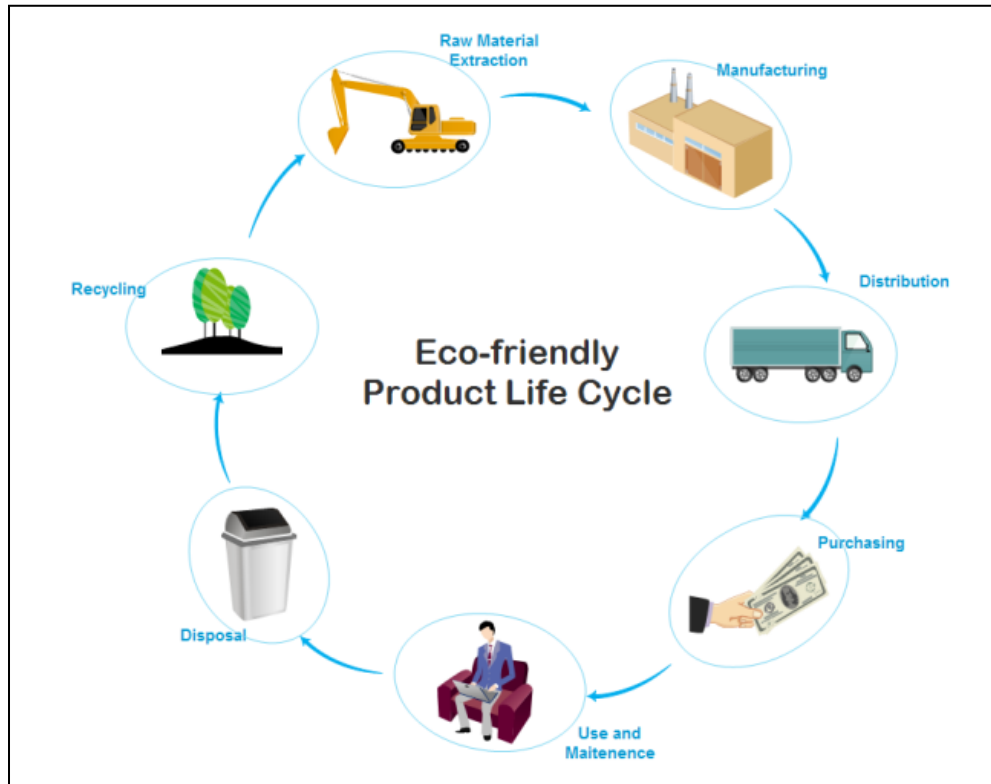

Figure 1. Green manufacturing process cycle [3]

Pollution means existence of harmful materials into the environment. . There are two different types of pollution and they are called, point source pollution and non-point source pollution. Point source pollution results when the contaminants come from a single point and it means source of the pollution can be identified. Whereas non-point-source pollution results when contaminants are introduced into the environment over a large, widespread area and it is difficult to identify source of pollution exactly [4, 5]. So point source pollution may be prevented at its source. Leakages and pours of lubrications from machines and equipment are frequently encountered problems. These types of problems are point source pollution and cause water and soil pollution.

Lubrication is an important process for dynamic equipment components to reduce friction and wear. Viscosity is one of the most important properties of an oil. Viscosity is a term used to describe resistance to flow at a particular temperature. This means that large viscosity of lubricant also requires large force against its own intermolecular forces in sliding motion between devices [6]. However lubrication has other benefits as help to prevent corrosion of materials and transfer contaminants to filter to be removed [7]. Lubricants may be divided into three parts according to their raw materials: mineral, synthetic, animal and vegetable. Mineral and synthetic lubricants are used in industry more frequently. Mineral oil is a petroleum based lubricant which has a low biodegradability. Mineral oils are toxic and can affect the environment negatively. Synthetic oil is generally petroleum based lubricants and manufactured by using chemically modified petroleum components. Although synthetic lubricants have better tribological properties than mineral oils they have low biodegradability as mineral oils [8, 9]. Animal and vegetable oils have high biodegradability which is important for green manufacturing technologies. In Fig.2, it is given biodegradability of some important lubricants. As it can be seen vegetable oils are biodegradable with 75-100 %, whereas mineral oils have a wide range, 15-85 % biodegradable.

Vegetable oil lubricants are potential substitutes for mineral oil hence vegetable oil is renewable, biodegradable and non-toxic. Furthermore they have good lubricity properties as well as mineral oils. Because of the presence of unsaturation, vegetable oils show poor oxidative and thermal stability [10]. It is conducted researches on improving thermal and oxidative properties of vegetable oils with viscosity modifiers [11]. In previous studies researchers have investigated that the use of additives in vegetable oil has a positive effect on some of its shortcomings [12, 13, 14]. However, modifier added vegetable oils are not commercially available so nowadays it is not possible to use it in industry. It is known that at low temperature vegetable oil can show good lubricity. Therefore in this study commercially obtainable pure vegetable oils were experimented into water pump bearings which relatively work in low temperatures.

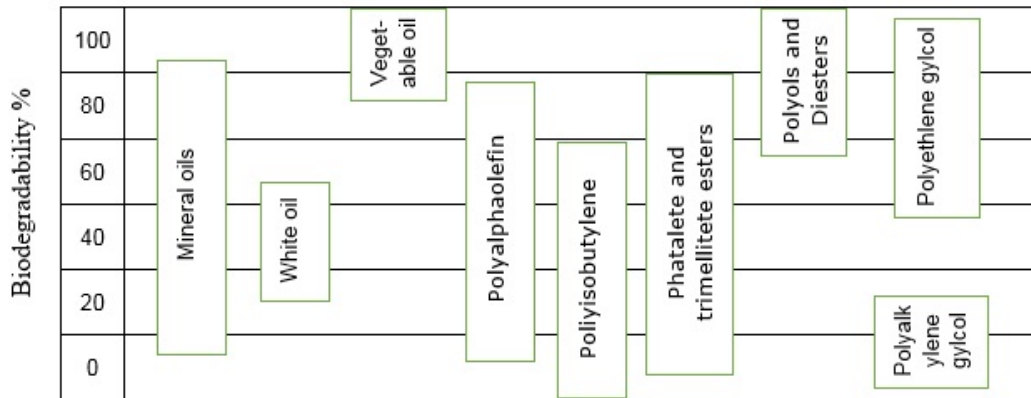

Figure 2. Biodegradability of some important lubricants [15]

Pumps can be defined as mechanical devices used to transfer, move or lift fluids of various types. Pumps are very important machines for industry, agriculture, municipality etc. Therefore pumping systems account for nearly 20% of the world's demand for electric energy [16]. So it is apparent that determining more biodegradable lubricant for pumping systems serve a very important purpose. As any rotary equipment, a pump need lubrication for bearings. Generally centrifugal pumps designed with an oil sump and this sump is filled with oil to lubricate bearings. Oils' tribological properties indicates bearing failures times. So both eco-friendly and good tribological properties is needed.

2. LUBRICATION OF BEARINGS IN CENTRIFUGAL PUMPS

Generally pumps are designed with two bearings for housing and they support the hydraulic loads on the impeller, the mass of impeller, shaft and loads due to coupling or belt drive [17]. Bearings must block up axial and radial loads. In Fig. 3. It is shown that a typical bearing arrangement for horizontal centrifugal pump. Bearing reactions can be calculated from the equations. In an ordinary selection impeller side generally selected as single row deep groove ball bearing, whereas motor side may select, single or double row deep groove ball bearing, cylindrical roller bearing, spherical roller or spherical roller thrust bearing etc. This selection for both sides depends on fluid specifications and types of duty, light, medium or heavy duties.

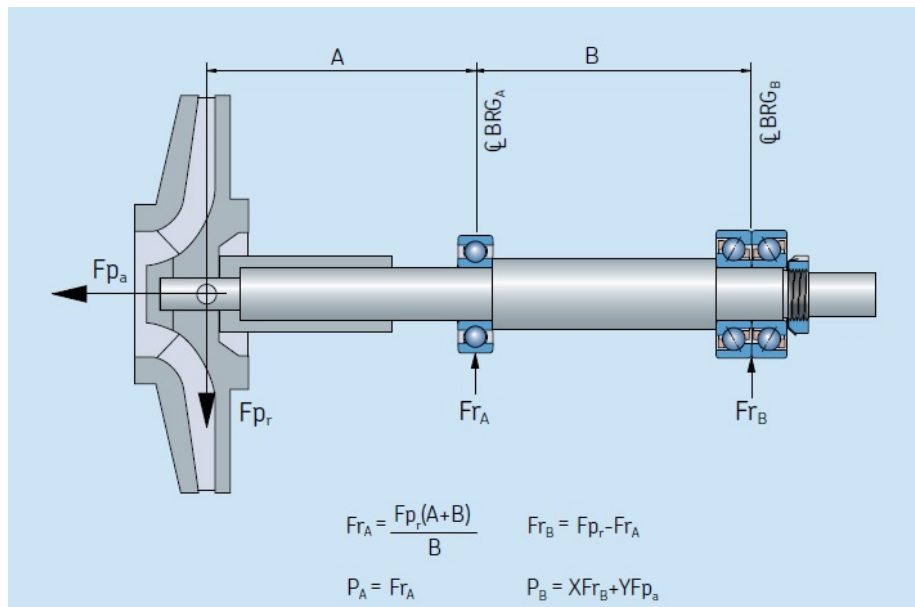

Figure 3. Typical bearing arrangement of a horizontal centrifugal pump [17]

Generally pumps bearing can be lubricated with two types of lubrication: oil or grease. Oil lubrication can designed as oil bath, oil-ring and oil mist lubrications. Fig. 4. shows oil bath lubrication type, which is the most common lubrication type for low and medium speed pumps. Also oil mist in and mist out shown with arrows.

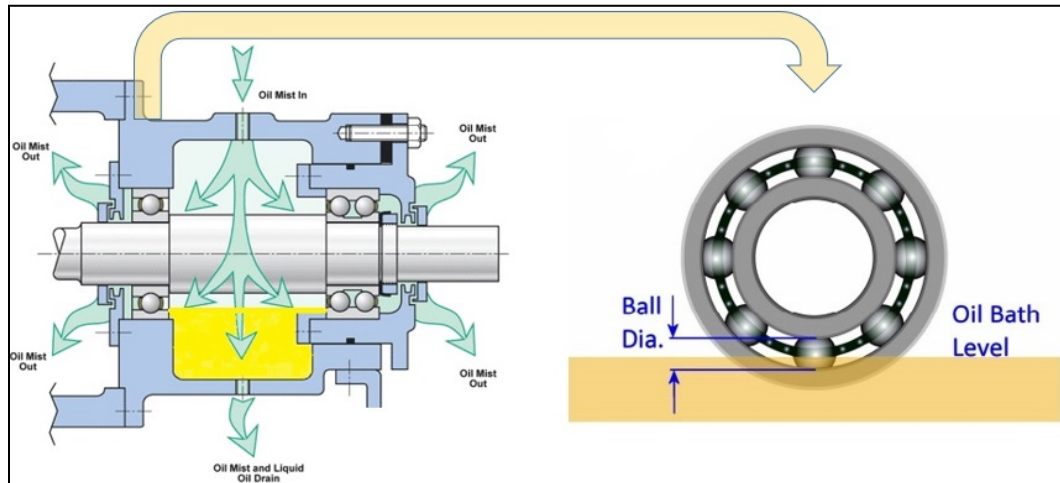

Figure 4. Oil bath lubrication for a centrifugal pump

Oil bath method is the simplest lubrication method for pumps. Working principle of this method is rotating components of bearing transfer the oil within the bearing and turns back into oil sump. Manufacturers suggest that oil must be completely changed after 1500 hours for 2900 rpm, and 3000 hours for 1480 rpm speed pumps [18]. These times are determined for mineral and synthetic oils.

Maintenance period of pumps show that bearings failures after a certain working hours. Several factors in bearing failure terminology are fatigue, brinelling, misalignment, electric arcing, contamination-debris, lubrication failures [19]. All failures have a signal before it occurred. Temperature and vibration of a bearing are very important data to observe bearing working. So especially in critical pumps – not only pump, may be other critical equipment – temperature and vibration instruments are mounted on pump. So that these information are kept on computer and can be analyzed.

3. MATERIALS AND METHODS

Sisecam Chemicals Group Soda Sanayii A.S. Turkey supported this study and experimental setup was mounted in Kromsan Chromium Chemicals Plant. For this study single stage horizontal centrifugal pump is used for experiments. Single stage centrifugal pumps have an oil sump for bearing lubrication. Without proper lubrication, bearings will overheat and seize. When a bearing must perform under demanding conditions, the lubricant selection becomes critical. Lubrication will affect life, torque, speed, noise, temperature and rust prevention [20].

Some of eco-friendly vegetable based lubricants which are most common used in studies are; canola, soy bean, sun flower, olive, cotton seed, castor, palm oils etc. It is difficult to supply some of these oils, whereas some of easily. This factor considered by selection of vegetable oil. But not only commercially availability, also tribological properties were evaluated. Ultimately canola and soy bean oil were selected for experiments. Reasons for selecting these oils are; flash points are high and evaporation losses are small, good lubricity, stable viscosity values, and cheap oils [6, 21]. Mineral, canola and soy bean oils viscosity, viscosity index, flash and pour points information was given in Table 1. Mineral oil was supplied from Shell Turkey, with Omala S2 G68 brand as industrial gear oil. Canola oil was supported from Zade Oil Company Turkey and soy bean oil was supported from Yonca Gıda Turkey with specified properties. This study aims to show pure oil tribological performance, so that canola and soy bean oils were experimented purely, without any additives. Centrifugal pump is used for pumping cooling water at 35 °C and it supplied from Standart Pompa as SCP 40/200 model with 1500 rpm. Bearing of the pumps are NU 306 for coupling side, and 7306 BEP for impeller side. After each test, bearing inner race punch pressed and separated. Samples were prepared and examined under SEM. According to the study oil sump of centrifugal pump filled with mineral, canola and soy bean oil respectively. Each experiment duration determined as 180 minutes. Vibration and temperature trends measured with on-line devices.

Table 1. Properties of experimented oils

Sample	Mineral oil	Canola	Soy bean
Viscosity 40 °C (mm ² /s)	68	33	38.6
Viscosity 100 °C (mm ² /s)	8,7	7.34	8.52
Viscosity Index	96	158	160
Flash Point (°C)	236	275	324
Pour Point (°C)	-24	-18	-16

4. RESULTS AND DISCUSSIONS

This work aims to show most practical industrial application for using vegetable oils in pumps. So that it is important for this study that results must be obtained on site. Through temperature instrument, temperature of the bearings were recorded for 180 minutes. Results are given in Fig. 5. For each lubricants six data processed on graphic and each data is average value for its period. For example 30 minutes means that average value for 0-30 minutes.

It can be seen on graphic that temperatures are increasing by time for all lubricants. Canola oil show thermal stability after 90 minutes at nearly 95°C. Results show that soy bean oil generate best thermal stability and best temperature values. At the end of the experiment housing temperature for soy bean oil is 90 °C which was 80 °C at first period. Mineral oil show better performance than canola oil. But there are not big differences between them. This finding support study of Stafanescu et. al., which is focused on lubricity capacities of canola and mineral oils [22]. They proved it is possible to use canola oil instead of mineral oil in industrial applications.

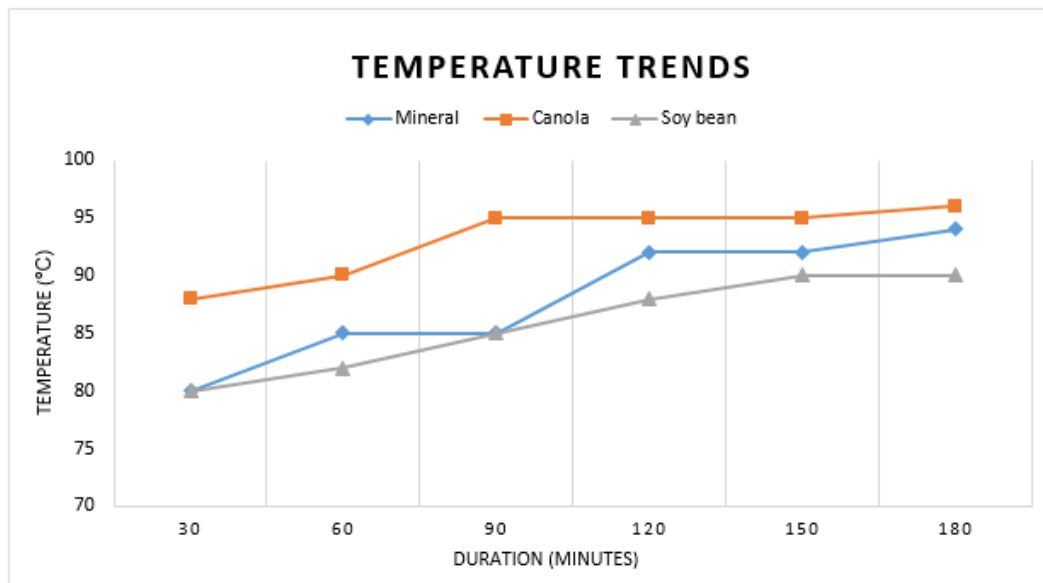

Figure 5. Temperature trends of three lubricants

Vibration results show that soy bean oil have lowest values during whole experiment time. However results for mineral oil is similar with soy bean oil and both trends are decreasing. Canola oil vibration trend is worse than others and it is increasing after 120 minutes. Otherwise at 180 minutes canola oil show 5.1 mm/s vibration value which is critical limit and may cross this limit after specific time.

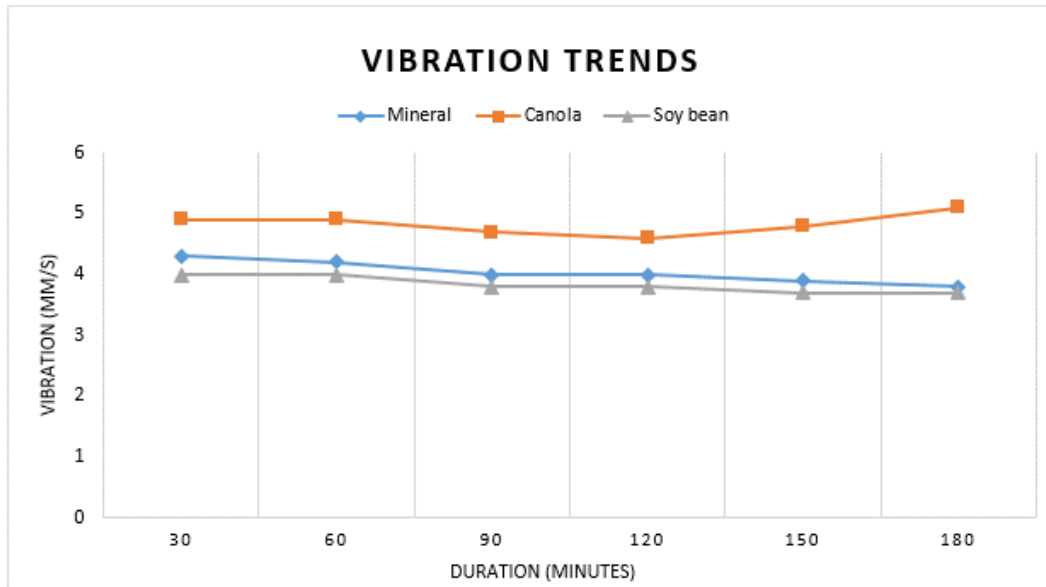

Figure 6. Vibration trends of three lubricants

SEM images of bearing inner race with mineral, canola and soy bean oils are shown in Fig. 7. from left to right respectively. Although it is not occurred scratched surface for mineral oil, it is viewed flaked surface. Flaked surface generally occurs in high temperature or inadequate lubrication. Temperature and vibration results do not support this SEM image. These results may be crosschecked with film thickness test. In SEM image of canola oil experiment shows that two huge digs occurred in bearing inner race surface. It may be because of worn small particles which occurred by friction of bearing rotating components. This means that lubrication is inadequate for bearing. Therefore some flakes determined between two digs, it is probably of high temperature.

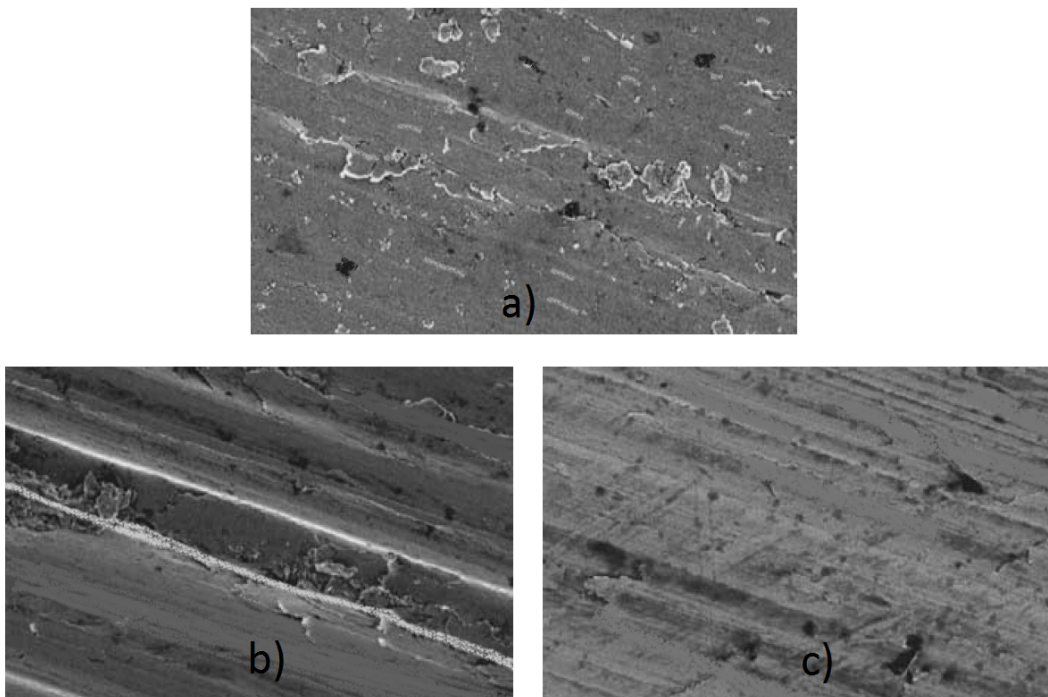

Figure7. SEM images of bearing inner race, (a) mineral, (b) canola and (c) soy bean oil

According to SEM tests best SEM image viewed in soy bean experiment. No flakes occurred on bearing inner race surface. Only some shallow dig occurred on surface which is acceptable as normal. Also some shallow and short scratches occurred perpendicular to ball rotation direction. Reason of these scratches may be occurred because of bearing gap. Vibration and temperature data supported SEM image for soy bean oil experiment.

5. CONCLUSIONS

The study focused on reducing oil contamination of water and soil in pump systems. It is known from site experiences that because of leakages from gaskets and while changing, oil pour out into environment in pumping systems. Pumps are one of the most important equipment in industry, municipality and agriculture. As it seen from data; pumps consuming nearly 20 % world's electrical energy. According to productivity strategy, studied should start huge impact. So that pumps are selected for this study. Vegetable based oil generally have good lubricity but some properties as oxidative and thermal stability must be improved by additives for many usage area. Actually studies are proceeding for optimizing tribological properties of vegetable oils. However this development is not commercial or expensive because processing is not complete. Therefore in this study pure canola and soy bean oil which are commercial were used for experiment versus mineral oil to show lubricity properties in pump bearings.

According to the experiment results best lubricity properties ranged as soy bean, mineral and canola oils respectively. Canola oil demonstrate worst lubricity properties and result are not acceptable for using canola oil in pumping systems. Flakes on the bearing inner race surface and relatively high vibration. As other researches studies canola oil can use base oil and by additives lubricity properties may improve. Soy bean oil can use instead of mineral oil without any additives even soy bean oil have better lubricity than mineral oil. According to general marketing survey shows that soy bean oil prices are 1.5 times more than mineral oils. Production and maintenance costs are important in industry. This study may continue for whole bearing life time to determine bearing replacement time. Considering costs and environmental factors a cost-benefit analysis may determine use case of lubricants.

As is known vegetable based oils are moreover used for food sector and actually this is primer usage of vegetable oils. Directly proportionate to population increase, vegetable oil need is going to increase. For sustainable future eco-friendly application should be accelerated. This means vegetable oils are going to use for as well as food and lubrication. However it is estimated a bottleneck in future. That vegetable oil production can't afford demand for both food sector and lubricant production. So that while technical studies continue for using vegetable oils for lubrication, otherwise it should be start up or continue the studies on more efficiently vegetable oils and increase agricultural area for vegetables for oil production.

ACKNOWLEDGEMENT

This study was mentally and financially supported by SiseCam Chemicals Group Soda Sanayi A.S.

REFERENCES

- [1] M.E. Porter and C. Linde, *Green and Competitive: Ending the Stalemate*, 73. rev., Harvard Bus., 1995.
- [2] R.A..R Ghazilla, N. Sakundarini, S.H. Abdul-Rashid, N.S. Ayub, E.U. Olugu, N. Musa, "Drivers and barriers analysis for green manufacturing practices in Malaysian SMEs: A Preliminary Findings." *12.th Global Conference on Sustainable Manufacturing*, Procedia CIRP vol. 26, pp.658 – 663, 2015.
- [3] (2016) Frost website. [Online]. Available: <http://www.frost.com>
- [4] "Aquarium of the Pasific data sheet" USA.
- [5] C.K. Jain, K.K.S. Bhaita and S.M. Seth. "Assessment of point and non-point sources of pollution using a chemical mass balance approach", *Hydrological Sciences Journal* vol. 43(3), pp.379-390, Dec 2009.
- [6] C.C. Ting, C.C. Chen. "Viscosity and working efficiency analysis of soybean oil based bio-lubricants." *Measurement* vol. 44, pp.1337-1341, Apr. 2011.
- [7] W. Cash. (2016) Noria Corporation webpage on Machinery Lubrication. [Online]. Available: <http://www.machinerylubrication.com/Read/28766/what-is-lubrication>
- [8] F.M.T. Luna, J. B. Cavalcante, F.O.N. Silva, C.L. Cavalcante. "Studies on biodegradability of bio-based lubricants", *Tribology International* vol.92, pp. 301-306, July 2016.
- [9] L. Havet, J. Blouet, F.R. Valloire, E. Brasseur, D. Slomka. "Tribological characteristics of some environmentally friendly lubricants.", *Wear* vol.248, pp. 140-146, Nov. 2000.
- [10] S.M. Alves, B.S. Barros, M.F. Trajano, K.S.B. Ribeiro, E. Moura. "Tribological behavior of vegetable oil-based lubricants with nanoparticles of oxides in boundary lubrication conditions.", *Tribology International* vol 65, pp. 28-36, Apr 2013.
- [11] L.A. Quinchia, M.A. Delgado, T. Reddyhoff, C. Gallegos, H.A. Spikes. "Tribological studies of potential vegetable oil-based lubricants containing environmentally friendly viscosity modifiers.", *Tribology International* vol. 69, pp. 110-117, Sept. 2013.
- [12] L.A. Quinchia, M.A. Delgado, C. Valencia, J.M. Franco, C. Galleos. "Viscosity modification of different vegetable oils with EVA copolymer for lubricant applications.", *Industrial Crops and Products* vol. 32 (3), pp. 607-612, Nov. 2010.
- [13] W.Y.L. Hsien, Ed. Sharma, *Utilization of Vegetable Oil as Bio-lubricant and Additive*, ser. SpringerBriefs in Molecular Science SpringerBriefs in Green Chemistry for Sustainability. London, England: Springer, 2015.
- [14] Y. Singh, R. Garg, A. Kumar. "Tribological behavior of pongamia oil as a lubricant additive.", *Energy Sources, Part A: Recovery, Utilization, and Environmental Effects* vol. 38 (16), pp. 2406-2412, Agu. 2016.
- [15] E. Durak, W.J. Bartz. "Eco-friendly hydraulic lubricants", in *3rd National Congress on Hydraulic and Pneumatic*, 2003, p. 182.
- [16] "Pump Lifecycle Costs: A Guide to LCC Analysis for Pumping Systems", *Europump and Hydraulic Institute, Exe. Summ.*, 2001.
- [17] *Bearings in Centrifugal Pumps (1M/AN 8/2012)*, SKF, 2012.
- [18] *Operation and Maintenance Manual of Single Stage Centrifugal Pump (BK SNT 03 12-10)*, Standart Pumps, 2012.
- [19] *Bearing Failure Prevention Guide*, The Torrington Company, 2010.

- [20] Ball Bearings Importance of Lubrication Selection, NMB Minebea Company, 2016.
- [21] Bio-based Lubricants: A Market Opportunity Study Update, Omni Tech International Company, 2013.
- [22] I.I. Stefanescu, C. Calomir, G. Chrita. "On the future of biodegradable vegetable lubricants used for industrial tribosystems.", Th Annals of Unversity Dunarea of Galati Fascicle vol.8, pp.94-98, 2002.

BIOGRAPHY

Fatih Dökme was born in Mersin, Turkey on 1984. He graduated from Mersin University mechanical engineering bachelor's degree on 2007 and master degree on 2013. He studied in Valencia Polytechnic University on 2005-2006 academic year in mechanical design engineering department. He is PhD candidate and studying in manufacturing engineering department of Mersin University. Also he is working as mechanical maintenance engineer in Sisecam Chemical Group Soda Sanayii A.S. Kromsan Chromium Chemicals Plant, Turkey since 2008. He focused on his studies sustainable future factors as health and environment in manufacturing area.

Muzaffer Turan was born in Mersin Turkey on 1984. He graduated Ankara University chemical engineering bachelor's degree on 2008. After the enforced military service, he started to work as production engineer in Sisecam Chemical Group Soda Sanayii A.S. Kromsan Chromium Chemicals Plant, Turkey in early 2010. In August 2015 he was promoted and still working as a chief of treatment plants. He focused on his studies sustainable future factors as health and environment in manufacturing area.

Ecological and socio-economic effects of invasive species *Rapana venosa* in the Black Sea Ecosystem

Hacer Saglam¹, Ertug Duzgunes¹

Abstract

Rapa whelk, Rapana venosa, is one of the most successful invasive species in the world. The rapa whelk moved to Black Sea, Mediterranean Sea, North and South Atlantic waters and North Sea from Asia waters via ballast water of the ships since 1946. It has been caused negative ecological and positive socio-economic effects. The most important ecological challenge is the reduction of the native biodiversity. Another one is the socio-economic effect. This species started to catch by dredges and became a very important income source for the small scale fisheries in this region since the 1980s. There is no domestic consumption in Turkey and it's exported to Asia countries as a frozen meat and provide foreign currency about 15 million USD. This paper gives information on ecological and economic effects of this invasive species in the Black Sea ecosystem.

Keywords: *Rapana venosa, ecological effects, socio-economic impacts, Black Sea*

1. INTRODUCTION

Rapa whelk is a successful invader because of high fecundity, early sexual maturity, fast growth rate and broad tolerance to salinity and temperatures. This invasive species distributed to the waters of 16 different countries due to the high ecological fitness. These are Russia, Ukraine, Bulgaria, Romania, Turkey, Italy, Greece, Slovenia, US, Argentina, Uruguay, France, Israel, UK, Belgium and Albania respectively (ICES, 2004).

The impacts of invasive species can change from ecological to socio-economic. Invasive species are a major threat to biodiversity. *Rapana venosa* is known to cause negative ecological and positive socio-economic effects in the Black Sea ecosystem.

According to STECF (2015) Rapa whelk landing in the Black Sea is 13403 tons in 2014; which the shares of Turkey, Bulgaria, Romania, Russia and Ukraine are 46%, 35 %, 15 %, 2.5 % and % 1.5 respectively. Landing data increased from 78 tons in 1985, with highest landings to 14034 tons in 2004 over a 180 fold increase in nineteen years. 50 % decrease in landings occurred between 2004 and 2014 due to overfishing in the Black Sea of Turkey. In 2015 Rapa whelk landing in Turkey is 8795 tons (TUIK 2015) (Figure 1)

There are limited studies about the effects of Rapa whelk on the Black Sea ecosystem. Their effects on the ecosystem are not well known in the Turkish Black coasts. Some authors reported about effects on marine ecosystem of this invader in the riparian countries (Drapkin 1963 in Russia; Chukchin 1984 in Russia; Zolotarev 1996 in Ukraine; Saglam 2003 in Turkey; Seyhan et al., 2003 in Turkey; Saglam et al 2008 in Turkey). This paper gives information on ecological and socio-economic impacts of this invasive species in the Black Sea ecosystem.

¹ Corresponding author: Karadeniz Technical University, Faculty of Marine Science, Department of Marine Science and Technology Engineering, 61530, Çamburnu/Trabzon, Turkey. hacersaglam@yahoo.com ertugduzgunes@gmail.com

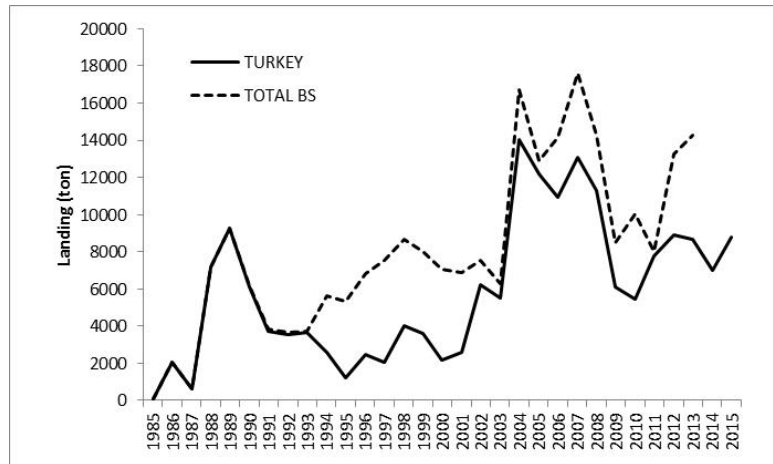

Figure 1. Landing data for Rapa whelk between 1985 and 2015 in Black Sea of Turkey and the riparian countries (TUIK, 2015; STECF, 2015)

2. EFFECTS OF RAPA WHELK ON BLACK SEA ECOSYSTEM

2.1. Ecological impacts

The ecological impacts of Rapa whelk in the Black Sea have been severe. Generally negative ecological effects are listed below;

- decreasing biodiversity
- preying on native species,
- changing in local food web and
- competing native organisms for resources (food and space).

Rapa whelk caused a significant damage to native benthos due to no predator in the Black Sea. The main predator of rapa whelk is starfish. But there is no predator for adult rapa whelk in the Black Sea. On the Bulgarian coast, Micu & Todorova (2007) reported the consumption of juvenile Rapa whelk by the crab, *Eriphia verrucosa*.

The direct threat of invasive species is preying on native species. Zolotarev (1996) suggests a broad dietary preference for bivalve molluscs including *Venus gallina*, *Gouldia minima*, and *Pitar rudis*. The native bivalves on the Gudaut, *Ostrea edulis*, *Pecten ponticus*, and *Mytilus galloprovincialis*, were the near extinction due to predation by Rapa whelk (Chukhchin, 1984). Chukhchin (1984) reported that young Rapa whelks consume barnacle, carrion and the meat of mussels, oysters, dead fish and crabs. Adult Rapa whelks consume *Mytilus* (mussels), *Ostrea* (oysters), *Tapes* (clams), *Venus* (clams), *Pecten* (scallops), and *Cardium* (cockles), and the gastropod mollusk *Patella* (limpets).

Some researchers reported that average food requirement for Rapa whelk changed between 0.2 and 1.2 g (Seyhan et al., 2003; Giberto et al., 2011). The mean wet mussel tissue weight is approximately 4 g. Snigirov (2013) stated that the population of *M. galloprovincialis* decreased and the mussel biomass decreased from 8300 tons to 3700 tons between 2004 and 2012 in Ukraine (Snigirov, 2013).

Establishment of Rapa whelk in Black Sea is facilitated a lack of competition from other predatory gastropods, a lack of direct predation on Rapa whelk and an abundance of potential prey species (ICES, 2004). After establishing this species reached a high abundance. The abundance of rapa whelk in Black Sea of Turkey increased from 42.10^3 in 1991 to 204.10^3 indv./km² in 2000. But its size decreased from 62 mm to 54 mm due to over fishing (Duzgunes et al, 1992; Saglam 2003).

Mollusk shells contribute to the formation of different Black Sea beaches; they may constitute more than 70% of all solid particles forming some beaches. Shadrin (2013) reported that *O. edulis* was the main producer of shells for beaches. When production of new *Ostrea* shells had stopped, a gradual degrading of beaches started. After about two decades the beaches disappeared or decreased with no natural protection against cliff abrasion present (Shadrin 2013). Dalgic & Yucel (2007) stated that about 99% of clams were dead or empty shells in Ordu coasts of the Black Sea.

Illegal beam trawling for harvesting of *R. venosa* along the Black Sea shelf has raised ecological concerns with respect to the mussel beds. Rapa whelk illegally fished during summer at nights. Approximately 70% of rapa whelk population are found in very shallow waters (Duzgunes et al., 1992; Knudsen et al., 2010).

Rapa whelk is harvested by dredge and beam trawls in Turkey and Bulgaria. But, in Romania *R. venosa* is selectively fished by SCUBA divers. Dredges are harmful to the bottom habitat and the biodiversity due to high by-catch rates. 13 different bycatch species caught by dredge. These are turbot, dragonet, goby fish, seahorse, sole, stargazer, scorpion fish, flounder, shore crab, harbor crab, striped venus clam, needle whelk and blood cockle (Celik & Samsun, 1996; Duzgunes, 2001). To protect ecosystem, Rapa whelk must catch with pot or diving instead of dredge (Saglam et al., 2008).

2.2. Socio-economic effects

Rapa whelk is commercially an important species. This species started to catch by dredge and get important revenue for the small scale fisheries in this region since the 1980s. There are eight whelk processing plants and most of them are located in Samsun and Sinop. The number of licensed fishing boats to harvest Rapa whelk increased from 121 to 596 between 2000 and 2005 (Saglam et al., 2008; Aydin et al. 2016). Total number of licensed vessels is 569 in the Black Sea in 2014 (Turkey: 437, Romania: 32, Bulgaria: 60, Ukraine 10 and 30 in Russia (STECF, 2015).

Due to no domestic consumption in Turkey, all the production is exported as frozen meat to Asian countries. It is provided foreign currency about 15 million euro in 2013. Not only exported meat of rapa whelk but also its shell and operculum are exported to foreign countries especially Japan, Korea, China, Thailand, US, France etc. (Saglam et al., 2008).

Local fishermen changed to their target species from demersal fish (due to decreasing stocks) to rapa whelk and whelk fishing had a high economic gain in this region. Rapa whelk fishermen sold them about \$ 0.4 per kg to whelk factory owners in the Black Sea of Turkey. They got \$ 3.2 million per year from whelk fishery in 2013 (TUIK 2013). The whelk processing plants provided the reduction of unemployment in this region.

REFERENCES

- [1] Aydin M, Duzgunes E, Karadurmuş U. 2016. Rapa whelk (*Rapana venosa* Valenciennes 1846) Fishery along the Turkish coast of the Black Sea. *Journal of Aquaculture Engineering and Fisheries Research* 2:85-96.
- [2] Çelik, O, Samsun, O., 1996. Farklı dizayn özelliklerine sahip algarnaların av veriminin ve av kompozisyonun araştırılması. *Su Ürünleri Dergisi*, **13**: 3-4, 259-272.
- [3] Chukhchin 1984. Ecology of the gastropod molluscs of the Black Sea. Academy of Sciences of the USSR, Kiev Naukova Dumka, 175 pp. (In Russian).
- [4] Dalgic G, Karayucel S. 2007. Investigations on the stocks of striped Venus (*Chamelea gallina* L., 1758) in Ordu's coastal zone of the Eastern Black Sea. *Journal of Fisheries International* 2:12-16.
- [5] Drapkin E. 1963. Effect of *Rapana bezoar* Linné (Mollusca, Muricidae) on the Black Sea fauna. *Doklady Akademii Nauk SRR*, 151(3): 700-703.
- [6] Duzgunes E, Unsal S, Feyzioglu M. 1992. Doğu Karadeniz'deki deniz salyangozu *Rapana thomasi* Gross, 1861 stoklarının tahmini. Proje no: DEBAG 143/6, KTU Sürmene Deniz Bil. Fak., Trabzon, Turkey.
- [7] Giberto DA, Schiariti A, Bremec CS, Claudia S. 2011. Diet and daily consumption rates of *Rapana venosa* (Valenciennes, 1846) (Gastropoda: Muricidae) from the Rio de la plata (ArgentinaUruguay). *J Shellfish Res*, 30(2): 349-358
- [8] ICES, 2004. Alien species alert: *Rapana venosa* (veined whelk). Mann R, Occhipinti A, Harding JM (eds) ICES Cooperative Research Report No. 264:14 s.
- [9] Knudsen S, Zengin M, Koçak MH, 2010. Identifying drivers for fishing pressure. A multidisciplinary study of trawl and sea snail fisheries in Samsun, Black Sea coast of Turkey. *Ocean and Coastal Management*, 53(5-6):252-269.
- [10] Micu D, Todorova V. (2007) Biodiversity of the western Black sea MarBEF Newsletter.
- [11] Saglam H. 2003. Doğu Karadeniz'deki deniz salyangozunun, *Rapana thomasi* Crosse, 1861 Biyolojisi. Doktora tezi Trabzon 101 s.
- [12] Saglam H, Kutlu S, Bascinar S, Dagtekin M, Selen H, Sahin A. 2008. Deniz Salyangozu Avcılığında Direce Alternatif Farklı Tuzak Modellerinin Geliştirilmesi. Proje no: TAGEM/HAYSÜD/2005/09/02/02. Su Ürünleri Merkez Araştırma Enstitüsü, Trabzon.
- [13] Seyhan K, Evren R, Emiral H, Engin S, Demirhan S. 2003. Diel feeding periodicity, gastric emptying and estimated daily food consumption of whelk (*Rapana venosa*) in the south eastern Black Sea (Turkey) marine ecosystem. *Indian Journal of Marine Science*, 32:249-251.
- [14] Snigirov S, Medinets V, Chichkin V, Sylantyev S. 2013. Rapa whelk controls demersal community structure off Zmiinyi Island, Black Sea. *Aquatic Invasions* 8: 289-297
- [15] STECF 2015. Scientific Technical Economic Committee for Fisheries. Black Sea Assesments (STECF-15-16). Edited by Massimiliano CARDINALE and Dimitrios DAMALAS. Ispra-Italy.
- [16] TUIK 2013. Fishery Statistics, Turkish Statistical Institute. Ankara.
- [17] TUIK 2015. Fishery Statistics, Turkish Statistical Institute. Ankara.
- [18] Zolotarev V. (1996) The Black Sea ecosystem changes related to introduction of new mollusc species. *Marine Ecology* 17:227-236.

BIOGRAPHY

She received her Bachelor degree from Karadeniz Technical University, Department of Fisheries Technology Engineering in 1994, Master of Science degree in 1997 and her PhD degree in 2003 at KTU, Fisheries Technology Programme. She was worked as Research Assistant at KTU from 1995 to 2003. She is an Associate Professor in the

Department of Marine Science and Technology Engineering at KTU since 2013. Her research interests are about invasive species, fisheries biology, feeding ecology, reproductive biology. She is the author of more than 40 scientific publications including articles, conference papers and book chapters. She is married and is a mother of two sons.

A Calculation Method for Determination of Household Solid Waste Tariffs for Municipal Administrations

Ibrahim Demir¹, Yavuz Soysal¹, Esra Tinmaz Kose²

Abstract

In Turkey, all activities within the scope of the waste management; waste collection, transportation, separation, recycling, disposal and landfilling-; are given as a task to the local authorities. Therefore, it is very important to determine the costs of waste management activities which have a significant place in municipality budgets. In this study; it was aimed to create a basis to be used to determine the tariffs which will be used to generate the economic source needed to implement the activities in the scope of solid waste management services done by related Solid Waste Management Administrators (including Metropolitan Municipalities, Municipalities and Municipality Unions). Although an important amount of knowledge is accumulated in our country related to the precautions needed to be taken as to overcome environmental problems caused by solid wastes, there are few studies about the cost dimension of waste management. This study was presented some suggestions for determination of tariffs which differ greatly among municipalities which have similar socioeconomical characteristics on the principles. In this study, a calculation module was created in an attempt to help with calculating cost of every step in waste management process, by using the cost data that were gathered together by various literature resources and some local governments.

Keywords: *Economical Tool, Household Solid Waste Tariffs, Unit Cost of Waste Management Activities, Waste Management*

1. INTRODUCTION

The environmental issues raised as a result of the industrial revolution haven't been seen a problem to be solved for a long time because of their limited initial effects and also because of the fact that economic development is seen as a priority objective. On the other hand, rapid population growth and the raise of living standards caused the consumption habits to change; then, as a result, it has led increase in the amount of waste that previously hasn't been experienced.

In Turkey, all activities within the scope of the waste management; waste collection, transportation, separation, recycling, disposal and landfilling-; are given as a task to the local authorities. Therefore, it is very important to determine the costs of waste management activities which have a significant place in municipality budgets.

Local authorities, who bear all the costs and responsibilities from collection to landfill, are having troubles to produce solutions about services in the scope of waste management due to amount of waste increasing day by day.

For the purpose of prevention and elimination of environmental problems, development and application of technical, legal and corporate economical tools are one of the main principals of waste management. Economical tools are the general names of every kind of methods that are used for achieving their environmental aims by producers and consumers related to their activities and besides considering benefit cost ratio in the meantime. It is possible to use the economical tools in an attempt to prevent environmental pollution and averting endangering ecological conditions. Reasons to use the economical tools can be summarized as:

- Enhancing economic efficiency of the legal regulations that are not economical,
- Providing flexibility for the legal regulations that are not flexible,
- Providing income generation and resource sharing,
- Having more continuity than the legal regulations [1].

According to the classification made by Organisation for Economic Co-operation and Development (OECD) economical tools are goods and service taxes (charges), emission taxes (charges), deposit (payback) systems, permissions, subsidies, penalties, trade licences, quotas, letters of guarantee, indemnity payments [2].

¹ Corresponding author: Istanbul Technical University, Department of Environmental Engineering, 34469, Maslak, İstanbul, Turkey. idemir@itu.edu.tr

² Namık Kemal University, Department of Environmental Engineering, 59860 Corlu, Tekirdag, Turkey

Although an important amount of knowledge is accumulated in our country related to the precautions needed be taken as to overcome environmental problems caused by solid wastes, there are few studies about the cost dimension of waste management. Considering the limited sources of our country, it is come to light that new studies needed must be done in an attempt to setting up a waste management system that is financially efficient [3].

Economical tools that are used in our country are listed as follows:

- Emission taxes/charges applied for the disposal of medical, industrial and hazardous wastes
- Consumer taxes /charges applied for industrial and domestic water usage and wastewater disposal
- Consumer taxes /charge applied for disposal of solid wastes by name Sanitation Tax
- Consumer taxes /charges paid for travelling in some highways
- Motor Vehicle Tax
- Special Consumption Tax
- Deposit payback systems stated by regulations,
- Penalties applied for the industrial plants which have wastewater discharges over the legal limits temporarily.

2. DETERMINATION OF HOUSEHOLD SOLID WASTE TARIFFS

2.1. Principles for The Determination of Household Solid Waste Tariffs According to The Local Legislation

Household solid waste tariffs are determined in accordance with Regulation on the Principles and Procedures for Determination of Tariff for Wastewater Infrastructures and Municipal Solid Waste Disposal Facilities (Official Gazette, 27.10.2010/27742) and Guideline on Determination of Tariff for Household Solid Waste [4].

The relevant regulations and guidelines involve diverse knowledge about tariff calculation principles, cost calculation methods, determination of tariffs, tariff control and approval processes, billing and recognition. These are used for determination of cost based tariffs in waste management systems. According to the Guideline, steps to be used in tariff calculations are:

- Extent of service is defined,
- Complete cost of service is calculated
- Equity assess is calculated,
- Average cost is calculated,
- Complete system cost is allocated to different waste producers,
- A tariff structure and type is chosen for billing.

Complete system cost is determined through the extent of the service provided to waste producers by household solid waste governance. All of the services provided by household solid waste governance to the waste producers consist of different processes of solid waste management. The household solid waste management system involving these steps is a process which has index of activities independent of each other on horizontal line or index of activities that are relatable and/or successive on vertical line. (Figure 1)

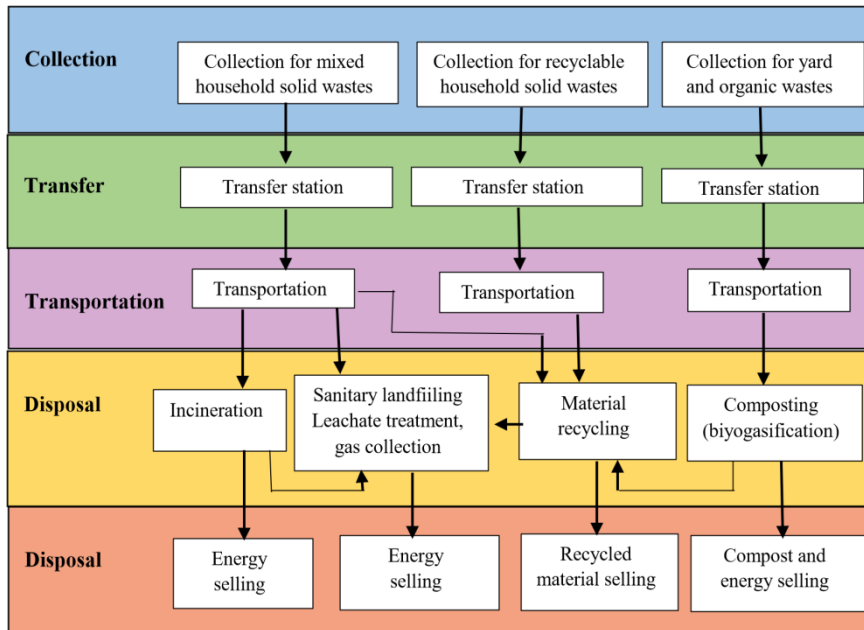

Figure 1. Waste Management Processes (Ministry of Environment and Forestry, 2011).

According to the complete cost principal, cost of every service provided is added to total sum to calculate the complete system cost. At the same time, complete system cost is calculated and allocated by system processes waste producers got their service. For example if solid waste governance has an incineration plant for disposal of solid wastes that are collected from industries, cost of this incineration plant is not reflected to tariffs of non-industrial household solid waste producers. Cost items in complete system cost are given in Figure 2.

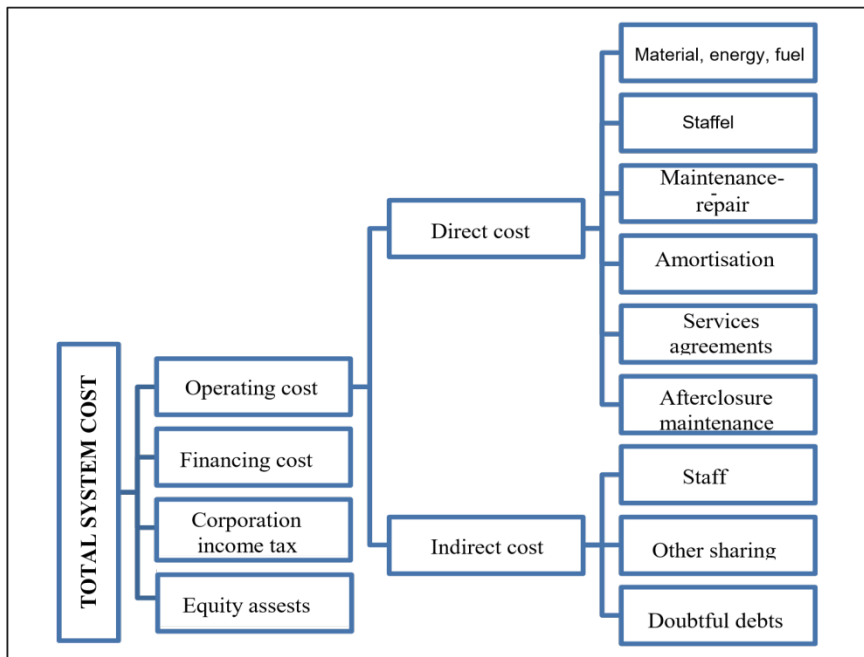

Figure 2. Components (cost items) of total system cost

According to the Guideline, for the system in use to be more agreeable and understandable to the waste producers, in determination step of solid waste tariffs water usage should not based on. Instead of this it is suggested that waste quantities should be determined using a simple calculation with factors like size of container and collection frequency (Official Gazette, 27.10.2010/27742).

Because different waste producers like houses, industries and offices get their waste management system service steps in different ways, it is important to put these waste producers into different groups to be able to form tariffs according to the polluter pays principle. On the other hand, as forming too many waste producer groups will raise billing and collection costs and hence lower income collected by complicating determination and distribution of tariffs, the Guideline suggests avoiding that.

2.2. Reflecting Tariffs to Waste Producers

Pursuant to relevant legislation in force, municipalities and unities are responsible for determination and approval of these solid waste tariffs on their councils and application of these determined tariffs right after (Official Gazette, 27.10.2010/27742, Ministry of Environment and Forestry, 2011)

According to the Legislation, every subscriber who use or will use the service is obliged to make a reciprocal contract with the local household solid waste authority (Official Gazette, 27.10.2010/27742). The contract describes which services waste producers get and which tariff they will pay on. Charging on the household solid waste services are made on water bills in regular intervals. In pursuant of the Guideline every service subscriber gets should be listed on the bill [4].

Household solid waste governances are responsible for setting up an accounting system that will provide that collected fees are only spent on household solid waste management services (Official Gazette, 27.10.2010/27742).

2.3. Evaluation of Household Solid Waste Tariffs Determined by Some Municipalities

It is the duty of municipalities and municipality unions in our country, charging subscribers for collection, treatment and disposal on wastewater and for collection, transportation and disposal on solid wastes with a predetermined tariffs according to Regulation on the Principles and Procedures for Determination of Tariff of Wastewater Infrastructures and Municipal Solid Waste Disposal Facilities (Official Gazette, 27.10.2010/27742) and Guideline on Determination of Tariff of Household Solid Waste.

Most of the municipalities in our country determined their solid waste tariffs in pursuant of the Guideline. However while some of the municipalities determined tariffs per household number, the others determined tariffs based on their clean water consumption. Tariffs are determined accepting total 1m³ water consumption on an assumption that water consumption is 0,15 m³/person-day and number of household members is as 4 person/household (Table 1).

Table 1. Household solid waste tariffs determined by municipalities in some municipalities of Turkey

Municipality (Province, county)	Household solid waste tariffs, determined by municipalities, per households (TL*/month)	Household solid waste tariffs, determined by municipalities, per water usage (TL*/m3)	Household solid waste tariffs per water usage (TL*/m3)
Edirne, Uzunköprü		1,11	1,11
Mersin, Erdemli		0,65	0,65
İzmir, Karabağlar	9,65		0,54
Rize, Pazar	6,28		0,35
Manisa, Gölçayırı	6,03		0,34
Aydın, Efeler	5,98		0,33
Kırklareli, Babaeski	5,93		0,33
Denizli, Merkezefendi	5,9		0,33
Çanakkale, Çanakkale	5,5		0,31
Kırklareli, Kırklareli	5,08		0,28
Eskişehir, Odunpazarı	4,82		0,27
İzmir, Buca	4,5		0,25
Manisa, Alaşehir	4,36		0,24
Samsun, Bafra	4,32		0,24
Muğla, Ortaca	3,5		0,19
Adana, Yüreğir	2,72		0,15
Edirne, İpsala	2		0,11
Adana, Seyhan	1,63		0,09

Considering the differences between tariffs, it is deduced that tariff determination studies based upon the Legislation and the Guideline are not consistent. In this study it is presented some suggestions for determination of tariffs which differ greatly among municipalities which have similar socio-economical characteristics on the principles.

3. DETERMINATION OF UNIT COST OF WASTE MANAGEMENT ACTIVITIES

In this study, by using the cost data that are gathered together by various literature resources and some local governments, a calculation module is created in an attempt to help with calculating cost of every step in waste management process. This module is engineered for being not only comprehensive enough to provide solid waste tariffs to be determined according to the complete cost principle, but also being simple enough to obtain and collect together data that will be used for calculation. Some assumptions are made in the light of data obtained from various sources. (Table 2).

Table 2. Assumptions made in the calculation of waste management system costs

Input data	Value	Unit
Household solid waste production per person	1,00	kg/person-day
Waste density in container	0,25	tones/m ³
Waste density in collection vehicle	0,50	tones/m ³
Volume of container	0,80	m ³ /number
Container filling rate	60	%
Container discharging time	2	min/number
Vehicle discharging time	0,10	hours/vehicle
Empty vehicle speed	70	km/hour
Waste collectin speed	15	km/hour
Full vehicle speed	45	km/hour
Vehicle lifetime	5	years
Shift system time	8,00	hours
Fuel price per liter	3,80	€/lt

Beside basic acceptances, some data are used such as population, total length of streets/roads in the residential area, distances from garage to residential area, from residential area to transfer station/ or to sanitary landfill, from transfer station to the sanitary landfill. (Table 3).

Table 3. Necessary information for calculation of waste management system costs

Input data	Unit
Population	person
Distance between garage and settlement	km
Movement distance in settlement	km
Distance between settlement and lanfill site	km
Distance between transfer station and landfill site	km
Director fee	€/month
Driver fee	€/month
Staff fee	€/month
Vehicle	€
Compaction equipment	€
Fuel consumption	lt/km
Vehicle fulling time	min.

Furthermore for the purpose of determination of waste collection and transportation costs, initial investment costs of vehicles and equipment and also average fuel consumption of these vehicles should be inputs of the module.

3.1. Unit Cost Calculation of Waste Collection

Total round time and round requirement are calculated via cruise time of collection vehicles and the time demand for dumping of containers to vehicles. Total time is calculated as in Equation 1. Works done in the time used on equations are given in Table 4.

$$\text{Total Time} = T1 + T2 + T3 + T4 + T5 \quad (1)$$

Table 4. Time descriptions used in total time calculation

Time	Time description
T1	Trip time of empty vehicle from garage to settlement
T2	Transfer time from container to vehicle
T3	Trip time of full vehicle from the last container to landfill site
T4	Discharging time of vehicle in landfill site
T5	Trip time of empty vehicle from landfill to settlement for 2th run

Vehicles that are used for waste collection in Turkey have carrying capacities of 7,5; 13,5 and 17,5 m³. For the waste collection step considering the collection vehicles with these carrying capacities, complete costs are calculated for the same residential area. The calculations of unit costs predicated on the acceptances mentioned above and evaluation related to the waste collection time are given on Table 5.

Table 5. Calculation results for unit cost of waste collection

Cost item	Collection cost for 7,5 m³ vehicle (€/ton)	Collection cost for 13,5 m³ vehicle (€/ton)	Collection cost for 17,5 m³ vehicle (€/ton)
Unit cost of staff	5,6	4,4	3,6
Unit cost of fuel	4,7	4,0	4,0
Unit cost of equipment	2,4	2,5	2,4
Unanticipated cost	1,3	1,1	1,0
Unit cost for collection	14,1	12,0	11,1

As determining cost values, assumptions such as that the waste collection vehicle is not affected by stop-and-go and waits caused by traffic and cruise on a normal basis are made. While adapting this calculation to residential areas, traffic condition of every one of the residential areas should be considered.

According to the results, while waste collection cost is 14,1 €/ton when collection is made with vehicles which have 7,50 m³ carrying capacity are used, it comes down to 11,1 €/ton when collection is made with vehicles which have 17,5 m³ carrying capacity. Hereunder as capacity of waste collection vehicle increases, unit waste collection cost decreases. On the other hand, acceptance of that utilization of large capacity vehicles will bring low cost is not valid for every residential area. Street and road width of residential areas, changes in waste quantity and composition, initial investment costs of vehicles cause a decrease or an increase between unit costs of small and large vehicles in some places.

3.2. Unit Cost Calculation of Waste Transfer and Transport

Waste transport cost consist of transferring the wastes collected from residential area to collection vehicles, from collection vehicles to carrying vehicles if there are transfer stations existed within the structure of waste management system and transporting with carrying vehicles to pretreatment or sanitary landfills. Waste transport cost involves initial investment and operating costs of waste transfer stations besides transportation of waste from transfer stations to landfills. In this study, reliable data needed for the calculation of these costs could not be obtained. Hence with the assumption of costs of installation of transfer stations and operating costs are 10% of transportation costs, by increasing waste transportation costs at this value, transfer and transportation unit costs are determined.

Unit costs calculated based on the acceptances and evaluations about waste transportation time in question are given in Table 6.

Table 6. Calculation results for unit cost of waste transfer and transportation

Cost item	Transfer cost for 17,5 m ³ vehicle (€/ton)	Transfer cost for 25 m ³ vehicle (€/ton)	Transfer cost for 35 m ³ vehicle (€/ton)
Unit cost of staff	1,6	1,2	0,8
Unit cost of fuel	2,0	1,4	1,2
Unit cost of equipment	3,7	1,5	1,2
Unanticipated cost	1,4	0,4	0,3
Unit cost for transfer	15,2	4,6	3,5

According to the results, while unit waste transfer and transportation costs are 5,4 €/ton when collection is made with vehicles which have 17,50 m³ carrying capacity are used, they come down to 3,5 €/ton when collection is made with vehicles which have 35,00 m³ carrying capacity.

3.3. Unit Cost Calculation of Sanitary Landfill

In this study considering the current station in our country and especially economical conditions of local governments, sanitary landfill is taken as the major disposal method and cost values of this method are calculated.

As fundamental item of initial investment costs of sanitary landfills land procurement cost differs greatly depending on geological and topographical structure of land. In addition to this, project and construction costs also vary from land to land. For example, while typical costs of geosynthetic clay lining which are used for making landfills impermeable are 4,5-6,5 \$/m², cost of natural clay lining differs significantly in a range between 5,4-53,8 \$/m²[5].

Because soil structure depending on capacity and other variables can get different values in different residential areas, making an assumption about an average value for initial investment costs of sanitary landfills will be misleading. When tariff determination studies are made by local governments, it is necessary to reflect the initial investment costs to unit cost. Furthermore it should not be forgotten that a solid waste leachate treatment plant will also needed to be built and its treatment efficiency is important, too.

To be able to make sanitary landfill cost calculations grounding on complete cost principle, investment, operating and monitoring after closure costs also should be known. In this study, information needed to calculate landfill unit costs could not get obtained. Therefore calculations are made based on an active plant in the present situation. The year 2011 cost items of Istanbul Metropolitan Municipality Odayeri and K m rc oda Sanitary Landfill that is chosen as example in this study are given in Table 7. For the year 2011 landfilled waste quantity is 5,2*10⁹ ton in the landfill mentioned. Unit sanitary landfilling cost is found to be 10,6 €/ton according to this [6].

Table 7. Accepted unit cost of sanitary landfilling data using in calculation

Cost item	Fee (€/ton)	Rate (%)
Equipment	496.842	0,9
Energy (Electirct, water, natural gas)	931.579	1,7
Fuel	22.357.895	40,5
Staff	13.290.526	24,1
Amortisation	4.098.947	7,4
Vehicle Repair and Maintenance, Spare Parts	4.906.316	8,9
Leachate treatment	8.818.947	16,0
Others (Repair, maintenance and others	248.421	0,5
Total	55.149.474	100
Unit cost of sanitary landfilling	10,6	-

3.4. Complete Unit Waste Management System Cost Calculation

With the aim of determining the complete unit waste management system cost; unit costs of collection, transfer and transportation and sanitary landfilling are added to total sum.

Every step included in solid waste services is another subject of privatization. Hence in an attempt to calculate the complete unit waste management costs, by increasing unit cost values at the rate of 25%, it is enhanced to make it involve contractor's profit and general expenses.

Including contractor's profit and general expenses, complete waste disposal cost is calculated as 41.6 €/ton. Complete cost consists of collection cost (%42, 17,6 €/ton), transportation-transfer cost (26%, 10,8 €/ton), and sanitary landfilling (32%, 13,3 €/ton) (Table 8).

Table 8. Calculation results for total unit costs of waste management

Cost Item	Fee (€/ton)	Fee added Contractors Profit (€/ton)	Rate (%)
Collection	14,1	17,6	42
Transfer and transportation	8,6	10,8	26
Sanitary landfilling	10,6	13,3	32
Total	33,3	41,6	100

REFERENCES

- [1] E. Çitil, C. Kınacı and Ö. Kayaıca, "Katı atık yönetiminde ekonomik araçların kullanımı ve çevre temizlik vergisi," *İTÜ Dergisi/D Mühendislik*, vol 9, pp. 28-36, Nov 2010
- [2] (2016) The Organisation for Economic Co-operation and Development website. Available:., www.oecd.org
- [3] E. T. Köse, N. Karakaya, and R.G. Aslan, "Katı Atık Yönetimi Maliyetleri: Bolu Örneđi," *Mühendislik ve Fen Bilimleri Dergisi*, pp. 126-131, July 2011
- [4] *Guideline on Determination of Tariff of Household Solid Waste*, T.C. Environment and Forest Ministry, 2011

- [5] İ. Öztürk, *Katı Atık Geri Dönüşüm ve Arıtma Teknolojileri El Kitabı*, İstanbul Büyükşehir Belediyesi Çevre El Kitapları Serisi, Ankara, Turkey, 2015.
- [6] C. Yaman, "İstanbul İçin Evsel Katı Atıkların Toplanması, Taşınması, Bertarafı ve Genel Kent Temizliğine İlişkin Maliyetler," in *Proc. T.C. Ministry of Environment and Urbanization Waste Management Symposium*, 2011, 16-21 Nisan 2011, Antalya.

Medical Waste Management in Turkey

Osman Atilla Arikan¹, Izzet Ozturk¹, Ibrahim Demir¹, Kadriye Elif Macin¹

Abstract

Medical wastes from health care institutions pose risks for public health therefore proper management of medical waste is very important. The purpose of this study is to present the general situation of medical waste management system in Turkey. In this context, first definition and amount of medical waste are given. Then, medical waste treatment methods are explained. Finally, medical waste management in Turkey is evaluated. The amount of medical waste generated in Turkey is approximately 1.5 kg/bed-day and 80000 tons/year. Considerable amount of medical wastes was disposed to landfills and covered with lime until 2009. Since 2010, sterilized medical wastes were sent to municipal landfills in a separate cell as a general practice. Besides the sterilization of medical wastes, incineration method is also rarely used. Medical waste disposal costs (excluding tax) ranged between 0.5-0.9 (average 0.7) €/kg for metropolitan municipalities and 0.6-1.1 (average 0.8) €/kg for other municipalities according to 2015 data. It is suggested that reduction of medical waste disposal costs is possible via removal of municipality cuts and decrease the amount of municipal solid waste in medical waste.

Keywords: *Cost, management, medical waste, sterilization.*

1. DEFINITION AND AMOUNT OF MEDICAL WASTE

Wastes generated from health care institutions are classified as medical wastes, hazardous wastes, radioactive wastes and domestic (municipal) solid wastes according to “Regulation on Control of Medical Wastes” which was issued in 2005 in Turkey [1]. In this regulation, medical waste is defined as waste generated from health care institutions and has infectious, pathological and sharp characteristics. World Health Organization (WHO) classifies wastes from health care institutions as infectious wastes, pathological wastes, sharps, genotoxic wastes, pharmaceutical wastes, chemicals, wastes containing high amounts of heavy metals, pressurized containers and radioactive wastes [2].

The amount of medical wastes changes according to the intensity of health care, location (rural or urban), type of health care facilities and clinics, the prevalence of single-use products, waste classification policies and regulations, separation and waste reduction practices, the procurement policies and country development [3]. The amount of medical waste in different countries ranges 0.5 to 4.4 kg/bed-day (Table 1) [4], and it increases proportionally with the income level of the country [5]. The amount of medical waste generated in Turkey is approximately 1.5 kg / bed-day [4]. According to the World Health Organization wastes from health institutions consist of 85% domestic waste, 5% chemical and radioactive waste and 10% medical waste (pathological, infectious and sharp waste) [2].

Table 4. Medical waste amounts in different countries [4]

Country	Medical Waste Amount (kg/bed-day)
Nepal	0.5
Iran	1.0
Vietnam	1.4
Turkey	1.5
Serbia	1.9
Pakistan	2.1
United Kingdom	3.3
Kuwait	3.7
Canada	4.1
USA	4.4

2. MEDICAL WASTE TREATMENT/DISPOSAL METHODS

In this section, information about the commonly used medical waste treatment/disposal methods such as landfilling, incineration, autoclave sterilization and microwave irradiation are given.

¹ Corresponding author: Istanbul Technical University, Department of Environmental Engineering, 34469, Maslak/Istanbul, Turkey. arikan@itu.edu.tr / ozturkiz@itu.edu.tr / idemir@itu.edu.tr / macinelif@gmail.com

2.1. Landfilling

Medical waste landfilling is a still practiced disposal method in many places, especially in developing countries. In this method, medical waste is stored in a separate cell in a landfill (Figure 1). The surrounding area of these cells should be fenced to prevent the entry and exit and medical wastes should be covered with lime. Sharp wastes must be taken into consideration during the disposal process (encapsulation). Most of the medical wastes were sent to landfills and covered with lime layer without any pre-treatment or process until 2009 in Turkey. This practice was ended in 2010.

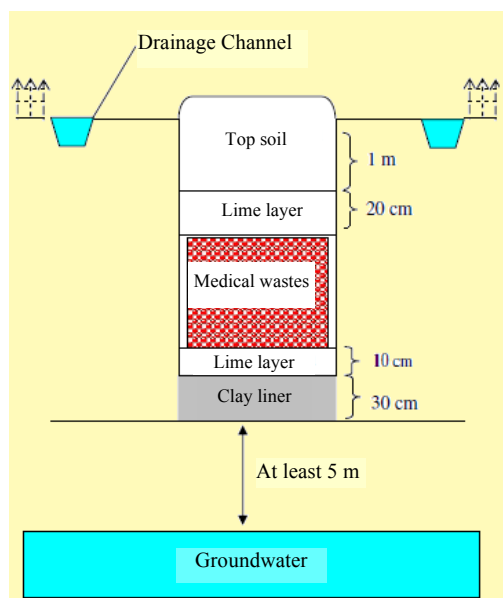

Figure 5. Landfilling of medical wastes

2.2. Incineration

Although incineration is the safest method for disposal of medical waste, initial investment and operating costs are quite high. While incineration method is commonly used in developed countries application of this technology is decreasing due to strict emission limits and high air pollution treatment costs. Incineration technology for the disposal of medical wastes is practiced in Turkey in three locations; IZAYDAS Inc. in Kocaeli, ISTAÇ Inc. in Istanbul and a private company in Ankara. ISTAÇ Medical Waste Incineration Plant with a capacity of 24 tons/day was constructed in 1995 (Figure 2). In this plant, medical waste is incinerated at 900-1200 °C in a rotary kiln. Incineration results in reduction of medical waste; 95 % by volume and 75-80 % by weight.

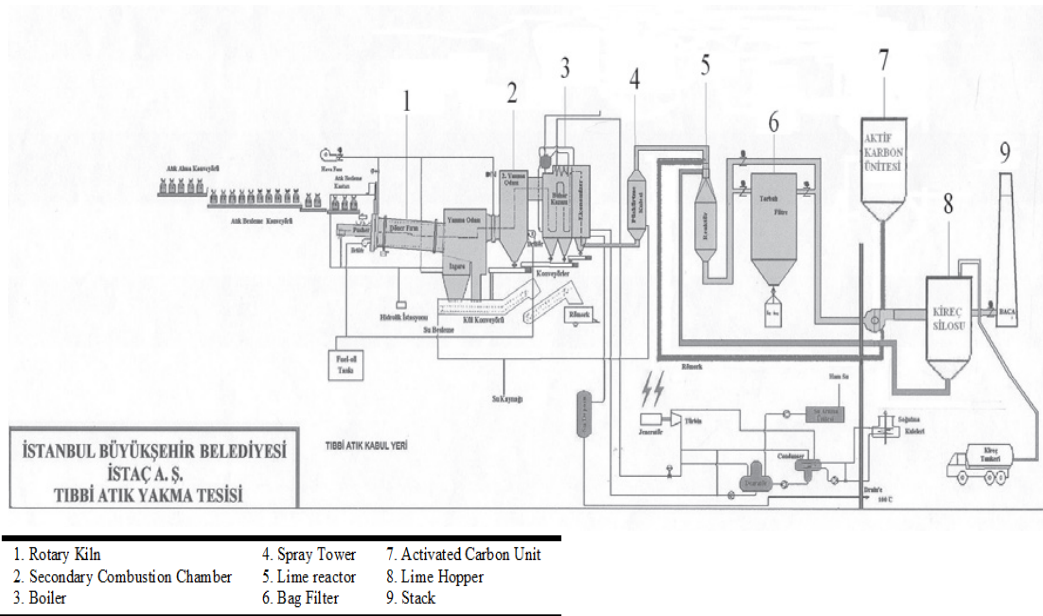

Figure 2. Flow diagram of ISTAC medical waste incineration plant

2.3. Autoclave Sterilization

Sterilization of microorganisms and many bacterial spores in wastes is possible to keep them at certain temperature (~ 121 ° C), pressure (~ 1 bar) and time (~ 60 minutes). (Figure 3). Autoclave sterilization requires shredding of medical wastes in order to obtain a homogenous mass. Shredding can be performed before or after sterilization. The medical wastes sterilized by this method are considered suitable for disposal in a municipal landfill.

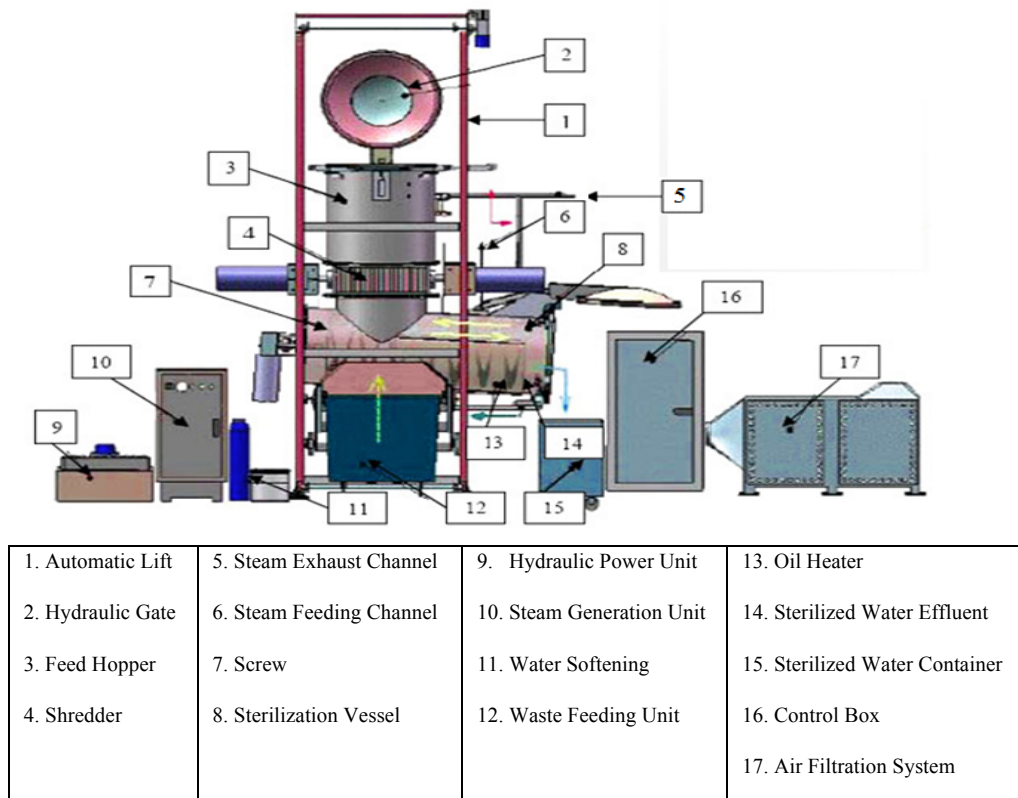

Figure 3. Autoclave sterilization of medical wastes

2.4. Microwave Irradiation

For microwave method, medical wastes are fed to a grinder, moisturized and exposed to irradiation for 20 minutes, sequentially. Irradiated wastes resulting from the microwave unit can be disposed in a municipal waste landfill.

3. MEDICAL WASTE MANAGEMENT IN TURKEY

Medical wastes in Turkey are managed according to the "Regulation on Control of Medical Wastes". Classification, separate collection and waste reduction are main principles for the management of medical waste. Domestic wastes from health care institutions should be collected separately and disposed with municipal solid wastes. Domestic recyclable wastes (glass, plastic, etc.) and other domestic wastes should be collected in blue bags and black bags, respectively.

Medical wastes should be collected in at least 150 microns thick, red, and labelled (stating that it contains medical waste) bags. Medical wastes should be temporarily stored, then collected by licensed firms and finally disposed at licensed facilities. Regulation on Control of Medical Waste is not applied to hazardous and radioactive wastes. While hazardous wastes are managed according to the Hazardous Waste Control Regulation management of radioactive waste are carried out by Turkey Atomic Energy Agency.

Along with Regulation on Control of Medical Waste, variety of tasks and responsibilities are given to following administrative units (Table 2).

- Ministry of Environment and Urbanization
- Governors
- Medical Waste Producers
- Municipalities

Table 2. Administrative structure of medical waste management in Turkey

Administrative Unit	Tasks and Responsibilities
Ministry of Environment and Urbanization	- Create a fundamental policy and develop legislation related to Medical Waste Management in the country.
Governors	- Give license to medical waste treatment plants - Apply the necessary enforcement to illegal activities - Collect medical waste data in provincial borders and submit it to Ministry of Environment and Urbanization - Give license to medical waste collection trucks and control their activities - Determine medical waste management tariffs with Environmental Board. - Monitor and control licensed companies.
Waste Producers	- Prepare and practice waste management plans for the unit. - Conduct waste reduction and source separation activities. - Provide safe and separate transport of wastes, using special containers. - Provide suitable conditions for temporary storage of waste. - Pay the medical waste management (collection, transportation and treatment) cost.
Municipalities	- Prepare and practice Medical Waste Management Plan as a subcomponent of Integrated Waste Management Plan.
<u>Metropolitan Municipalities:</u>	- Provide safe collection and treatment of medical wastes by licensed companies. - Prepare and practice Medical Waste Management Plan for the city.
<u>Other Municipalities:</u>	- Provide safe collection and treatment of medical wastes by licensed companies.
Waste Management Union (union structure recommended by ministry)	- Prepare and practice Medical Waste Management Plan for the city.
<u>Municipalities not included in any of the Waste Management Union</u>	- Provide collection and disposal of medical wastes according to Medical Waste Management Plan.

Amount of medical waste generated in Turkey is between 70000-100000 tons/year (Figure 4) [6]. When the last four year values are taken into consideration, medical waste generation is observed around 80000 tons/year. The number of medical waste disposal facilities in Turkey over the years is given in Figure 5 [7]. Considerable amount of medical wastes was sent to landfills and covered with lime layer without pretreatment until 2009. Since 2010, sterilization system has gained importance. According to 2014 values, sterilization was the most common system (number of facility 52) in Turkey for medical waste management treatment, followed by incineration technology (number of facility 3). Sterilized medical wastes are sent to municipal landfills in a separate cell. The total capacity of medical waste treatment facilities in Turkey has reached approximately 200000 tons/year which is almost twice of the amount of medical wastes generated. Therefore, when permits (license) are given to new constructed facilities, availability of medical wastes should be checked. Otherwise, this could lead problems such as low efficiency and increase of treatment costs.

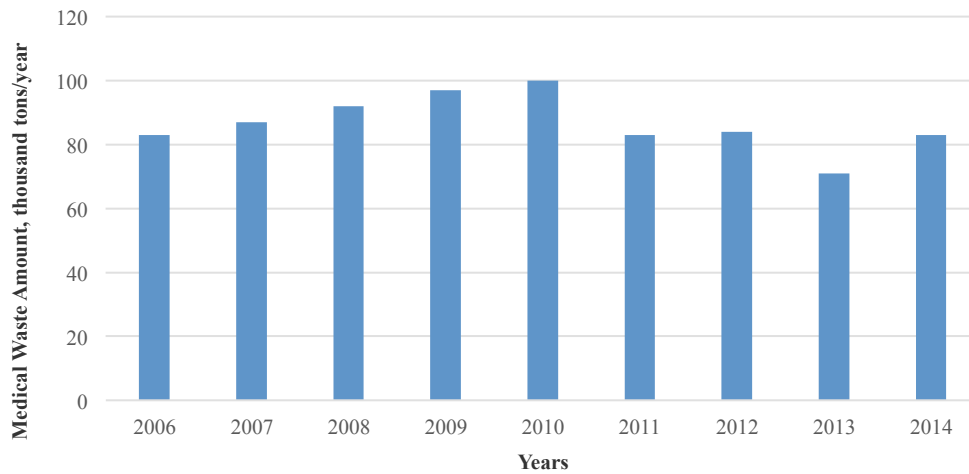

Figure 4. Medical waste generation in Turkey [6]

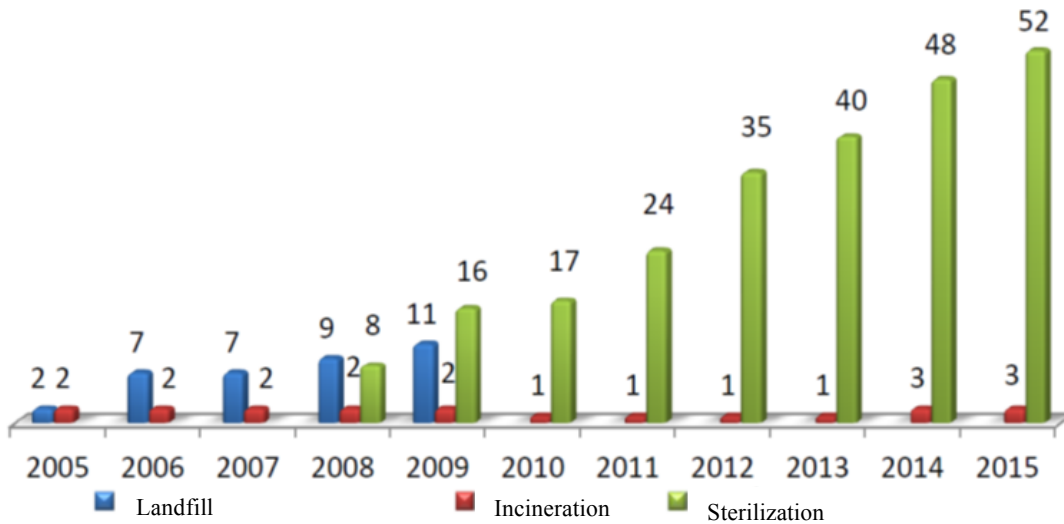

Figure 5. Medical waste disposal/treatment plants in Turkey [7]

Medical waste disposal costs for different treatment methods are given in Table 3 [4]. Incineration has highest capital cost. Capital costs of autoclave sterilization plants are between 1.4 to 10 million \$ in Turkey depending of the capacity (Table 4) [8]. Medical waste disposal costs for other countries are given in Table 5 and their values are in the

range of 0.4 to 1.2 €/kg. Medical waste treatment costs in Turkey were around 0.6-0.7 €/kg in 2013 [4] and 0.6-0.7 €/kg in 2015 [7].

Table 3. Capital and operational costs of medical waste treatment methods [4]

Method	Capacity (ton/day)	Capital Cost (\$)	Operational Cost (\$/kg)
Autoclave Sterilization	0.6-90	30,000-1,780,000	0.13-0.36
Microwave Irradiation	0.6-10	70,000-710,000	0.10-0.42
Incineration	6.0-100	120,000-6,000,000	0.15-0.30

Table 4. Capital costs for autoclave sterilization plants [8]

Capacity (ton/day)	Item	Cost (\$)
1	400 m ² construction (reinforced concrete/steel construction)	240,000
	Equipment	1,150,000
	Total	1,390,000
5	700 m ² construction (reinforced concrete/steel construction)	420,000
	Equipment	1,500,000
	Total	1,920,000
10	1000m ² construction (reinforced concrete/steel construction)	600,000
	Equipment	2,500,000
	Total	3,100,000
100	3000m ² construction (reinforced concrete/steel construction)	2,000,000
	Equipment	8,000,000
	Total	10,000,000

Table 5. Medical waste treatment costs for different countries [4]

Country	Disposal Method	Disposal Cost (€/kg)
Italy	Unstated	0.6-1.2
Greece	Unstated	0.5 (Except company profits)
Poland	Incineration	0.5-1.0
	Sterilization	0.4
Turkey	Sterilization	0.6-0.7 (2013) [4], 0.7-0.8 (2015) [7]

Medical waste disposal costs in Turkey are determined by the Provincial Environmental Committee and prices vary from city to city. Although, municipalities are responsible for medical waste collection and disposal management of medical wastes are usually contracted to private firms. Collection, transport and treatment of medical wastes are accomplished by private firms. Some municipalities get a certain percentage of the revenue (the rate of 8-40%) from companies in the tenders as a municipal share [4]. Disposal of medical waste cost was around 65 million € for health care institutions in Turkey in 2012 [4]. Medical waste disposal costs (excluding tax) ranged between 0.5-0.9 (average 0.7) €/kg for metropolitan municipalities and 0.6-1.1 (average 0.8) €/kg for other municipalities according to 2015 data [7].

4. CONCLUSION

Medical waste management in Turkey has been improved especially in last 10 years. A major part of medical waste (> 90%) is disposed to municipal landfill after sterilization and incineration method is also used on a limited scale. The management of medical wastes are mostly carried out by private firms. Health care institutions are obligated to pay medical waste management costs. Treatment of medical wastes is directly related to public health and it is one of the most important service of municipalities. However, some municipalities see this as an income source which leads to increase in medical waste management cost. It is suggested that reduction of medical waste disposal costs is possible via removal of municipality shares and decrease the amount of municipal solid waste in medical waste.

REFERENCES

- [1] "Regulation on Control of Medical Wastes", Ministry of Environment and Urban Planning, 2005. Ankara.
- [2] Y. Chartier, J. Emmanuel, U. Pieper, A. Prüss, Rushbrook, P., Stringer, R., Townend, W., Wilburn, S. and Zghondi, R., "Safe management of wastes from health-care activities", World Health Organization.
- [3] UNEP, "Compendium of technologies for treatment/destruction of healthcare waste", United Nations Environment Programme Division of Technology, Industry and Economics International Environmental Technology Centre, Osaka, Japan, 2012.
- [4] A. Küçük, "Economy of Waste Management", *Sayıştay*, vol. 90, pp. 73-95, 2013. (in Turkish)
- [5] E. S. Windfeld and M. S. L. Brooks, "Medical waste management—A review", *Journal of Environmental Management*, vol. 163, pp. 98-108, 2015.
- [6] "Environmental Indicators", Ministry of Environment and Urban Planning, 2014. Ankara.
- [7] "Waste data", Ministry of Environment and Urban Planning, 2015. Ankara.
- [8] Era Environmental Technologies, 2015, İstanbul.

Relation Of Built And Natural Environment's Effects On Public Health

Muhammed Fatih Cetintas¹,

Abstract

Living beings interacted with each other and benefit from natural resources in earth. In life beings; What is human beings main needs after respiration?

We can classify as three parts for human needs:

- Food and Drink needs,*
- Shelter needs,*
- Wearing needs.*

One of the basic needs of humanity with the housing needs of the industrial revolution and the decrease as a result of the need for manpower with mechanization, emerged urban concept with the emigration of rural areas and cities is planned in an irregular manner as part of nature -without harming the very nature instead of designing nature- designed in need of shelter and the city has become the axis it consists of dense building blocks. Density of the built environment in the city turned into a concrete jungle with population growth by completing development continues to grow vertically with the technological advances in production systems. This text reference to the ecological cycle is necessary for living things, it emphasized the importance of the natural environment. The damage caused to the environment of man-made destruction of nature is devoted to diseases classified and could lead to damage human health because of the concretion in terms of the destruction of natural environment and increasing the built environment effects human health. In this paper; the relations between ecologic cycle and life, built environment and life will research according to relation of built environment and ecology and built environment will evaluate with effects of human health. As a method, literature review and discourse analysis method will use. The example of Istanbul will evaluate according to changing built environment and ecology ratio and effects of built environment on public health will be state.

Keywords: *Public Health, Built Environment, Human, Ecology, Concretion.*

1. INTRODUCTION

Living beings interacted with each other and benefit from natural resources in earth. For understanding this interaction, we can examine loop. What is the easiest definition of loop? According to (TDK, 2016) Loop is the multiple repetition of any event. According to the theory of loop, every living beings benefits from each other thanks to this life rule and life of living beings continue. What is the life cycle?

Life cycle: Consecutive and interlinked stages of a product service system, from the extraction of natural resources to the final disposal [1]

What is the type of life loop?

- 1- Biotic cycles
 - 1.1. Energy Cycling (Nutrient Cycling)
 - 1.2. Photosynthesis
 - 1.3. Respiratory
- 2- Abiotic cycles
 - 2.1. Oxygen, carbon, nitrogen, sulfur, phosphorus Cycling
 - 2.2. Sedimentary Cycle
 - 2.3. Hydrologic Cycle [14]

In this paper; the relations between ecologic cycle and life, built environment and life will research for examine effects of built environment on public health

All of life loops is necessary for living beings for to continue own life. Where ecology in this life loop? According to [11]; There is four level of Ecology:

Four levels of ecological organization:

¹ Corresponding author: Architectural Design Programme, Istanbul Technical University

m.fatih.cetintas@gmail.com

- Population - group of individuals of the same species occupying a common geographical area
- Community - two or more populations of different species occupying the same geographical area
- Populations and communities include only biotic factors
- Ecosystem - a community plus its abiotic factors, e.g. soil, rain, temperatures, etc.
- Biosphere - the portion of the earth that contains living species. It includes the atmosphere, oceans, soils and the physical and biological cycles that affect them [11]

Population, community, ecosystem and biosphere interact each other and continue life in earth (Figure 1). Respiration and water is the main needs of life beings. Life beings benefits ecology to meet respiration needs (Figure 2, 3, 4)

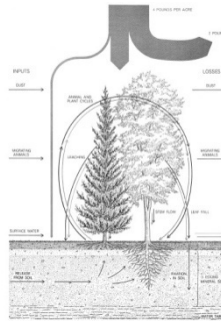

Figure 1: Ecosystem Cycle [17]

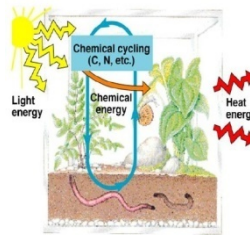

Figure 2: Ecosystem & Biosphere Cycle [11]

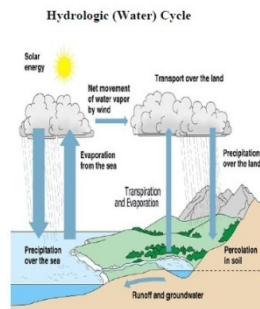

Figure 3: Hydrologic Cycle [11]

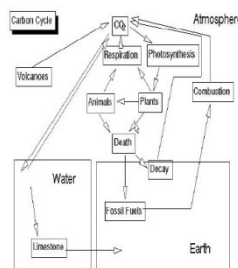

Figure 4: Carbon Cycle [11]

In life beings; What is human beings main needs after respiration and water? We can classify 3 part human needs:

- Food and Drink needs,
- Shelter needs,
- Wearing needs.

1.1 Maslow's Pyramid of Needs

US researchers Abraham H. Maslow, based on clinical observations made in 1954 of human needs (or their motives), has found that they are subject to a pyramidal hierarchy [12]. Maslow are two assumptions in this classification is based on, [10];

- 1- There are the basic needs of human behavior;
- 2- The satisfaction of some needs are more important than others. People who go to the important and intense way to meet other needs after you meet those needs. Consequently, the "need to know what their needs are in order to understand the behavior of individuals"[7].

The basic needs of people's behavior according to Maslow can be handled in five places, respectively, and they are as follows (age, s.35-46):

- Physiological Needs: Hunger, thirst, sexuality (resume generation) to sleep, excretion, breathe, needs such as shelter are in this category.
- Safety Needs: Physiological needs are met will it be something that felt security needs after that.
- Spirituality and Love Needs
- Appreciation and Respect Needs
- Self-Actualization: Even if it goes above the individual needs if you still have the ability, knowledge, will feel a void within himself thinks not reveal exactly as skills and will try to correct this deficiency.

Housing needs, one of the basic needs of humanity, has gone to the vertical growth path as a result of rapid urbanization and industrialization. However, this situation is a result of increasing population is forcing the benefits that human nature in the area. As a result of this, the natural elements (water, soil, etc.) are contaminated. As a result of pollution caused by humans it is again given the damage adversely affects public health and leads to many health problems.

2. EFFECTS OF BUILT ENVIRONMENT ON PUBLIC HEALTH

Initially helpless against nature and human nature while connected to a life with nature, culture and technology, it produces over time has become dominant position. However, the relationship between man and environment, human-centered, which excludes compensation is a relationship that destroys the environment and ecological balance in the levels would not be possible [13]. This situation directly affects the life cycle and is becoming an unsolvable. Given the nature of the built environment created by man-made damage to the ecological cycle and therefore affects the human health effects up to disrupt the people still suffer.

Need of shelter is one of the most basic human needs. The emergence of urbanization and rapid urbanization along with the industrial revolution was shaped by the city ignored the ecological balance in the urban context, it has turned to intensive building blocks. Conceived with the natural environment, the built environment should be designed; in this case the destruction of the natural environment as a result of structure-structure formed on the basis of the relationship has become. Consisting of eight principles, one of the principles laid down by Arne Naess, 'Human to non-human lifestyle intervention is excessive and go rapidly deteriorating situation due to the excessive intervention.' This can be summarized in the Principle. Intervention by man and is situated in a harmful situation results in terms of ecological destruction and human beings again. It leads to dense urban construction and environmental pollution based on the structure of this case is in building relationships and negatively affect human health. The reason for this effect is still occur environmental pollution by humans. Environmental pollution and human health interaction can be classified as follows:

Environmental Pollutions:

- 1- Air pollution,
- 2- Water pollution,
- 3- Soil pollution,
- 4- Noise pollution,
- 5- Visual pollution. The problems are the result of irregular and intense urbanization in the city is.

Such environmental problems for human health;

- 1- Health problems caused by air pollution: Increase in air pollution negatively affect the health of living beings, especially humans leads to a variety of acute health problems. Long-term exposure to pollutants leads to the emergence of chronic health effects. Air pollution and health effects of cough, bronchitis, heart disease and lung cancer and ranges. Although the negative effects of pollution monitoring, even in healthy people, some vulnerable groups are being affected more easily and more serious problems arise [2].
- 2- Health problems caused by water pollution: [3] health problems resulting from water pollution, water pollution in the book are listed as follows:

Health unsuitable for water with a substance that can cause a variety of diseases carried by and contained. Can carry dissolved or undissolved inorganic salts, bacteria, and parasites. These are polio, infectious hepatitis, enteritis, the FMD, Rinderpest, Swine fever etc.

- 3- Health problems caused by soil pollution: Taking the matter as a result of soil pollution, especially the liver, kidneys and impairs nutrient functions in a very large proportion [4].
- 4- Health problems caused by noise pollution: Noise pollution affects people's perception of hearing health and negatively disrupt the physiological and psychological balance and reduces business productivity [2].

3. VERTICAL GROWTH AND PUBLIC HEALTH IN CITIES

'Multi-layer structures' issue basically is a different dimension of the problem of the use of urban land for the benefit of society. In particular, the city 's central (center) is horizontal and in the land sections, vertical as possible to urge people to take advantage of an intensive multi-storey structures, directs the skyscraper. " [8]. High buildings next to the city skyline negatively contribute in accordance [6] brought problems of high buildings in town planning; remain unsolved infrastructure systems, a negative effect in terms of the structure of each shade and sun, the formation of dark streets, and the traffic circulation problems. Vertical urbanization; Besides the deterioration of the city skyline air, water, soil, from respiratory disease to cancer causing noise pollution it is causing many diseases. By directly affect the airflow of skyscrapers blocking the causes of air pollution. The need for water is forced due to the population density is concentrated in the areas of vertical growth and the increasing amount of waste leads to water pollution and soil pollution. Dense population in these regions; It increases the vehicle traffic and thus give rise to noise pollution as well as contributing to air pollution.

4. SKYSCRAPER AND AIR POLLUTION

Radikal newspaper dated 01.12.2016 According to the news (ÇAPA, 2016)[5] 29 thousand people lose their lives every year in Turkey as a result of air pollution. Journal of Environmental Engineers Istanbul Branch members in a statement given to Kubra Ayçiçek, Ayçiçek; EU air pollution limits in Turkey and stressed that the limit values set by the World Health Organization. Also good in Turkey / air quality is defined as the central United States and said that unclean Considered in terms of Europe, Istanbul Esenyurt shows examples that the value of 126 days is exceeded and the assessment of Europe with comparison made, it is likely the emphasis we can see that Esenyurt'a 365 days smog left makes [5]. Ayçiçek; 'One of the dominant factors in the high buildings and in the world in terms of air pollution in Istanbul. The wind direction Istanbul's northern forests. Thence protect the boreal forests means protecting the future of clean air. Because the north to the incoming fresh air inside Istanbul's spreading. The achievable amount also hit the highest tower in the city when you can not access fresh air. The city's pollution causes the accumulation into saying 'it refers to the relationship skyscrapers and air pollution. In the newspaper; The Turkish Medical Association (TTB), the Turkish Thoracic Society (TTS), Association of Physicians for the Environment, Greenpeace, Public Association of Health Professionals (HASUDER is) like clean Thoracic Society of Aircraft components that organizations have created met, air pollution Era Group Co-Chair Dr. Nilufer Aykaç Kongar is to say that the problem of air pollution is very important public health. Kongar, the last few weeks indicate that a significant increase in the number of applicants in the field of breast disease. Although reports on air pollution 'cause of death' as the lungs of not recorded air pollution, heart and explained that serious effects on the nervous system pulmonologist Kongar experts, asthma, chronic bronchitis, respiratory tract infection, heart attack, note that experienced health problems such as heart failure attract. Kong, showing examples of OECD data 'in the World 7 million people per year die due to air pollution. According to the OECD report last year the number of people who lost their lives due to air pollution in Turkey, 29 thousand people. Who lost their lives in traffic accidents this rate up to 6 times' stating that emphasizes the seriousness of air pollution.

According to (YeniSöz, 2016) the news dated 21/01/2016; According to a study conducted in Canada, living in multi-storey buildings or skyscrapers is having a heart attack more and more unhappy. Sit in a heart attack in the building more than doubled in the study who reported that no one was rescued.' Proceeding on behalf of the skyscraper called the high-rise buildings, metal coating and radiation collection due to the high technological equipment that works like a hard-and of insulation made from synthetic materials, leaving the deprived in the fresh air of living for obstructing the breathing of the building is said to cause psychological problems breaking environmental liaison and isolate the imposition of a life . News chairman of the chamber of architects, in an

interview conducted by Eyup Muhçu, "First of all forests are destroyed along with concretion and the ecosystem is deteriorating. Soil water permeability is eliminated. When on the concretisation of water resources can change the bed of ground water resources, water resources are not feeding and inadequate to meet the city's water needs" opinion. Muhçu noted that adversely affect the air flow along with high construction "of these structures which airflow needs of the city, cutting winds either a front or changing its direction. In this manner causes an increase in the temperature of the concrete building. That energy used in buildings, solar heat with a manifestation of the building, air and causes the inability to meet ground water," he says. News of the sequel "Skyscrapers, asphalt roads and the lack of green in the city 'heat island' effect specifies that Professor Dr. Orhan Sener said: "What does this mean? According to the environmental temperature around 3 degrees higher it is happening. More green spaces will be felt, though less heat in Istanbul. in the same city skyscrapers to receive a more intense why, when you compare the temperature in a more green space; You'll see the skyscraper is 2-3 degrees warmer." he says.

The news (Ünal, 2015)[16] Dated 07.10.2015 is given in Milliyet Chamber President Eyüp Muhçu. According to Muhçu interview: "There are many negative return concretion mania. First, forests are destroyed along with concretion and the ecosystem is deteriorating. Soil water permeability is eliminated. When concretisation of water resources can also be changed on the bed of the underground water resources, water resources are not feeding and inadequate to meet the city's water needs. At the same time negatively affected by air currents with high building. The structures of the airflow needs of the city, cutting or changing the direction of the winds or the front. In this way, cementation is causing an increase in the city's.

That energy used in buildings, solar heat with a manifestation of the building, air and causes the inability to meet ground water. increase seen in the glass facade skyscraper affects warming. The sun's rays and the reflection of the glass surface to the increasing heat generated by the collision obstacle to see the large shadow of the sun brought people in both the skyscraper. You need to add that the expansion of paved roads, the reduction of soil surface can also cause flooding and other natural disasters. "

According to News of (Kadıoğlu, 2012)[9] dated 12.02.2012 Milliyet newspaper article in Kadıoğlu 'plain from the mountains in the night sky is open cold air starts flowing. Thus, it can be cold at least until the plains to the mountain top. When the Cold valley full of fruit in there, starting from the lower branches of trees begins to freeze. It also filled the valley with cold water vapor in the air condenses airborne contaminants can cause heavy fog. Because of all these reasons, this area of Istanbul in the winter air, noting that there are three main areas where pollutants exceed the pollution limits:

4.1. Golden Horn Valley (Eminönü, Fatih, Bayrampaşa, Eyup, Eyup, Eyup, Okmeydanı Kasimpasa and Beyoglu).

4.2. Top Goztepe, Kozyatağı, Example Quarter, Bulgurlu, Acibadem, Hasanpaşa and Fikirtepe, Sisli Buyukdere Street.

4.3. District between Besiktas and Sisli (Fulya Quarter) are listed in the form.

After the continued improvement of fuel quality and efficient combustion provided indicates that no doubt will occur less amount of pollutants released into the atmosphere and emissions. Spread in the atmosphere of pollutants and which will allow them to disperse wind street and judges be created parallel to the wind direction of the street to be blocked this point, narrowly keeping as much as possible the building of the prevailing wind direction that is perpendicular to the front, to be placed away from the direction of arrival of the dominant winds of high buildings, etc. It emphasizes the need.

5. CONCLUSION

Need of shelter is one of the most basic human needs. The emergence of urbanization and rapid urbanization along with the industrial revolution was shaped by the city ignored the ecological balance in the urban context, it has turned to intensive building blocks. Conceived with the natural environment, the built environment should be designed; in this case the destruction of the natural environment as a result of structure-structure formed on the basis of the relationship has become.

Consisting of eight principles, one of the principles laid down by Arne Naess, 'Human to non-human lifestyle intervention is excessive and go rapidly deteriorating situation due to the excessive intervention.' This can be summarized in the Principle. Intervention by man and is situated in a harmful situation results in terms of ecological destruction and human beings again. It leads to dense urban construction and environmental pollution based on the structure of this case is in building relationships and negatively affect human health. The environmental problems may be classified as air, water, soil, noise and visual pollution. Respiratory diseases by air, with water; infections, with soil pollution; metabolic diseases leads to many health problems, especially hearing the noise tract diseases. Damaged people's health as a result of demolition natural habitat built environment and human life is endangered.

REFERENCES

- [1] 14040.2 ISO. (2006). DRAFT: LIFE CYCLE ASSESMENT-PRINCIPLES AND GUIDELINES.
- [2] cevreonline. (2016). <http://cevreonline.com/cevre-kirliligi-cesitleri/> adresinden alındı
- [3] Çağatay Güler, Z. Ç. (1994). *Su kirliliği* (1.Baskı b.). Ankara: Sağlık Bakanlığı.
- [4] Çağatay Güler, Z. Ç. (1997). *Toprak Kirliliği* (1. Baskı b.). Ankara: Sağlık Bakanlığı.
- [5] ÇAPA, E. (2016). *Radikal*. 08 16, 2016 tarihinde <http://www.radikal.com.tr/cevre/hava-kirliligi-alarm-veriyor-yilda-29-bin-kisi-oluyor-1497158/> adresinden alındı
- [6] Demir, N. (2011). YÜKSEK YAPILAR VE SÜRDÜRÜLEBİLİR ENERJİ. İstanbul: Yıldız Teknik Üniversitesi.
- [7] Eroğlu, F. (1996). *Davranış Bilimleri*. İstanbul: Beta.
- [8] Geray, C. (1991). Çok Katlı Yapılar ve Kentsel Toprak Siyasamız. *Sbf, C. 46*, (S. 1-2,), s. 225-242.
- [9] Kadioğlu, M. (2012). *Milliyet Gazetesi*. 08 16, 2016 tarihinde <http://www.milliyet.com.tr/gokdelenler-havanin-kalitesini-etkiler-mi-mikdat-kadioglu/pazar/yazardetay/09.12.2012/1639097/default.htm> adresinden alındı
- [10] Koçel, T. (1982). İşletme Yöneticiliği. *İstanbul: İÜ İşletme Fak. Yay.* (No.132.).
- [11] LANCOUR, K. L. (2015). GENERAL PRINCIPLES OF ECOLOGY. GREEN GENERATION -2015 & 2016 .
- [12] Maslow, A. H. (1970). *Motivation and Personality* (2 b.). New York: Harper and Row.: Harper and Row.
- [13] Özerkmen, N. (2002). From Antropocentric Perspective to. *Ankara Üniversitesi Dil ve Tarih-Coğrafya Fakültesi Dergisi* , 1-2 (42), 167-185 .
- [14] slideplayer. (2016). *slideplayer*. 04 2016 tarihinde <http://slideplayer.biz.tr/slide/1940848/> adresinden alındı
- [15] TDK. (2016).
- [16] Ünal, B. (2015). *Milliyet Gazetesi*. 08 16, 2016 tarihinde <http://www.milliyet.com.tr/asiri-sicaklarin-suclusu-dev-gundem-2085720/> adresinden alındı
- [17] WOODWELL, G. M. (1967). TOXIC SUBSTANCES AND ECOLOGICAL CYCLES. *SCIENTIFIC AMERICAN*, 216(3), 24-31.
- [18] YeniSöz. (2016). *Yeni Söz Haber*. 08 16, 2016 tarihinde <http://www.yenisoz.com.tr/binalar-yukseldikce-hayatlar-kisiliyor-haber-9548> adresinden alındı

Meiofauna As An Environmental Bio-Indicator In Marine Ecosystems

Murat Sezgin¹, Derya Urkmez², Vera Vukanic³

Abstract

Metazoan meiofauna are defined by their body size (44-1000 μm) and are the most diversified element of the marine biota: as many as 24 of the 35 animal phyla have meiobenthic representatives which live in meiofauna, whether for all their life or just temporarily. It is the most abundant benthic group in the marine realm, the function of meiofauna in marine benthic systems seems to be much more complex than previously supposed, and requires further research. The use of meiofauna as a biological indicator is a more recent development than the utilization of macrofauna in the assessment and monitoring of aquatic ecosystems. The advantages of the former are numerous and strongly emphasized by many scientists, while some of the arguments traditionally advanced against their use underline difficulties in identification, the high rate of sampling frequency and the microscopic size of these organisms. However, new technologies and tools, such as standardized methodologies, electronic identification keys, molecular approaches and the creation of new indices, currently allow for and promote the use of meiofauna in ecological studies. Whilst less is currently known about meiofaunal responses to pollutants, they have certain inherent advantages over the macrofauna in the determination of the biological effects of pollutants at the community level. Meiofaunal communities are inherently more stable, both qualitatively and quantitatively, on a seasonal and year-to-year basis, than those of the macrofauna, and it is obviously easier to monitor temporal changes in community structure from a stable rather than a fluctuating baseline. The meiofauna are abundant and diverse even in habitats, such as estuaries, which are subjected to considerable natural physical and chemical stress and where only a small numbers of macrofauna species occurs. This work has been supported by bilateral meiobenthos project (TÜBİTAK-The Scientific and Technological Research Council of Turkey and MoS-Ministry of Science of Montenegro, project number 114Y376).

Key words: Meiobenthos, bio-indicator, Black Sea

1. INTRODUCTION

Univariate indices are commonly used at general ecological and pollution studies (Olsgar and Somerfield, 2000). These biotic indices mainly study macrobenthic community of marine and transitional waters, while the meiobenthic component of benthos has not been considered. The advantages of the study of macrobenthos are numerous and strongly emphasized by many scientists. However some other researchers underline the difficulties in identification of meiofauna, the high rate of sampling frequency and the microscopic size of these organisms. However, new technologies and tools, and the creation of new indices, currently allow for and promote the use of meiofauna in ecological studies.

2. METHODOLOGY

A seasonal sampling was carried out at 2 depths (2 and 4 m) along Sinop coasts (Figure 1). Undisturbed samples were collected from 8 stations as three replicates. Material was retrieved via Scuba divers using a cylindrical stainless steel coring tube and samples were fixed with 75% ethanol onboard. In laboratory, samples were washed through sieves with mesh sizes 1 mm for the upper and 63 μm for the lower size limit. Washed material was stained with Rose Bengal solution and examined under a dissecting microscope using modified Bogorov chambers, counted, identified at higher taxonomic groups and stored in 2 ml cryo tubes including 75% ethanol.

Nematode and harpacticoid densities will be used to determine Ne/Co ratio of the stations and maturity index will be calculated based on the colonizer-persister values of the nematode genera.

$$\text{Maturity Index (MI)} = \sum_{i=1} v(i) \cdot f(i)$$

Where $v(i)$ is the c-p score of genus i and $f(i)$ is the frequency of that genus in a sample.

¹Sinop University Faculty of Fisheries; Marine Biology and Ecology Department, TR5700 Sinop, Turkey biologistms@gmail.com¹

²Sinop University, Scientific and Technological Research and Application Center (SUBITAM), TR57000 Sinop, Turkey deryaurkmez@gmail.com

³Department of Biological Sciences, Faculty of Biology, State University Novi Pazar, Serbia veravukanic@yahoo.com; vvukanic@np.ac.rs



Figure 1. Study area

3. RESULTS AND DISCUSSION

Ne/Co Ratio

Raffaelli and Manson (1981) proposed the Nematodes/Copepods ratio (N/C) as a fast, easy and reliable tool to monitoring the effect of organic matter enrichment. This index was supported by the different pollution tolerance of these two main meiobenthic taxa. Abundance and diversity of nematodes can decline after pollution events. A number of investigations also showed that nematodes (Figure 2) are tolerant to hypoxic/anoxic conditions and moreover, selected species may be abundant under extreme conditions (Ürkmez et al. 2015) which in turn may serve as biomonitoring species. In contrary, harpacticoid copepods are generally more sensitive to pollution and environmental disturbances compared to other meiofaunal taxa (McLachlan 1978; Lee et al. 2001; Wetzel et al. 2001). Recently, Ne/Co index was improved (Rubal et al. 2009) and new baseline values are suggested. This ratio has been used for biomonitoring studies and reviewed by Baguley et al (2015).

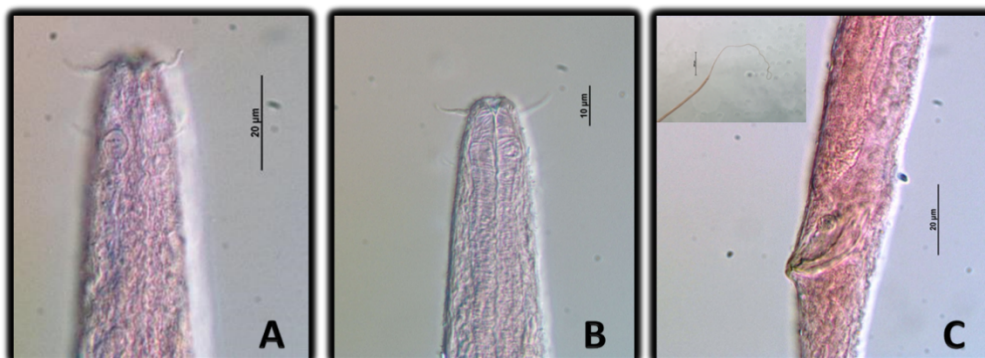

Figure 2. *Trefusia aff. longicaudata* was found to be abundant at suboxic zone off Sinop Bay (Southern Black Sea)

A. Male anterior end showing amphid

B. Male anterior end showing pharynx ad cephalic setae

C. Lateral view of male posterior end showing tail and the spicules.

Nematode Maturity Index

The Maturity index (MI) has been proposed by Bongers in 1990 based on nematode life strategies to assess the ecological quality of habitats. Initially it was created for terrestrial and freshwater environments and then it was

extended to be used in marine and brackish ecosystems (Bongers et al. 1991). However, few data are available on its response to physical stress and we previously conducted a preliminary research at the area using MI values. In the scope of our project, we will evaluate an expanded data of marine free-living nematodes found in Sinop Bay (Southern Black Sea) to test Maturity Index and life strategy traits (c-p classes) to determine the possible physical disturbances in the area.

The scope of this study is to apply Ne/Co ratio and Maturity Index on our data and see if they are reliable in monitoring organic pollution in coastal sediments. The results will also be used to identify species which have a high bioindicator potential and can be used for the development of an assessment method in marine ecosystems. According to the European Marine Strategy Framework Directive (2008/56/EC), seafloor integrity should be at a level ensuring the safeguarding of the structure and function of ecosystems. Consequently, monitoring the quality of the environment appears to be essential for devising effective protection strategies and appropriate forms of management of marine systems.

5. ACKNOWLEDGEMENTS

This work is a part of a joint project financially supported by TÜBİTAK (The Scientific and Technological Research Council of Turkey) and MoS (Ministry of Science of Montenegro) (Project Number: 114Y376) .

REFERENCES

- [1] Rubal M, Veiga P., Besteiro C. 2009. Nematode/Copepod index: Importance of sedimentary parameters, sampling methodology and baseline values. *Thalassas, An International Journal of Marine Sciences*, 25 (1): 9-18pp.
- [2] Ürkmez D, Brennan M, Sezgin M, Bat L. 2015. A brief look at the Free-living Nematoda of the oxic/anoxic interface with a new genus record (*Trefusia*) to the Black Sea. *Oceanological and Hydrobiological Studies*. 44(4):539-551

Biography

Murat Sezgin: Professor of Marine Biology and Ecology in Sinop University Faculty of Fisheries (SNU-FF). He received the Ph.D. in marine ecology field from Ege University, İzmir in 2003. Research interests: Black Sea, Mediterranean Sea, Crustacea taxonomy and ecology, benthic ecology, benthic pollution, exotic species. He has collaborated in umpteen national and international research projects, published 100 papers in peer review journals and he is author more than 60 communications in national and international conferences.

Zooplankton Studies in the Boka Kotorska Bay (Southern Adriatic) Larvae

Vera Vukanic¹, Murat Sezgin²

Abstract

Data presented in this paper are results of a study performed in period January-December 2010 in Boka Kotorska Bay. During that period, hydrographic parameters and zooplankton were intensively sampled at seven fixed stations. Three of these stations were placed in the shallow part of the Bay near the shellfish farm, and four in the middle parts of each smaller bay that are part of Bokokotorski Bay. The program and locality of stations in the study were purposefully chosen to enable a thorough study, yielding new data on hydrographic conditions and zooplankton biocenosis. The results are based on the yearly cycle of monthly series of zooplankton sampling, as well as the data on physical-chemical conditions of the sea. Boka Kotorska Bay is a relatively closed part of the sea, with specific features such as the pronounced influence of surrounding land and an immense influx of fresh water. The impact of the open sea is strongest in Hercegovski Bay, while toward the inner waters of Boka Kotorska Bay it gradually decreases. The special ecological conditions in Boka Kotorska Bay are reflected on taxonomic structure, distribution and abundance, both of individual species and the zooplankton as a whole. Results of this research include the biological monitoring at the Bay, based on following certain species within the zooplankton and the functional attributes of the ecosystem, plankton diversity and communities of zooplankton species. The combination of collected data were used to define the ecosystem of the Bay and to determine the degree of anthropogenic degradation within it. In this paper we present the hydrographic data of Boka Kotorska Bay, together with data on presence, abundance and distribution of the larvae: decapoda, ophiurida, echinida, cirripedia, bivalvia, bipinnaria, tornaria, auricularia, mitraria, nauplius larvae and pisces larvae.

Key words: Adriatic, Boka Kotorska Bay, zooplankton, larvae

1. INTRODUCTION

Bay of Boka Kotorska represents a relatively confined part of the sea, which is made of 4 bays with their specificities, such as a distinct impact of washing from the surrounding land, intake of fresh waters during the colder period of the year and the influence of open sea, which is the most pronounced in the Bay of Hercegovi. Ecological specificities of the Bay of Boka Kotorska reflect on taxonomic composition and distribution, both of the individual species and of the overall zooplankton. Specific ecological conditions and geographic situation of the Bay of Boka Kotorska make it an eutrophic biotope the biota of which experiences the impact of fresh waters intake from the land and streaming from the open sea. In this paper we present data on composition of meroplanktonic community and immanent larvae. Alongside with the investigation of zooplankton, physical and chemical parameters of the environment have been measured and analysed. The paper comprises the investigations of meroplankton in all the bays of the Bay of Boka Kotorska (Bay of Kotor, Bay of Risan, Bay of Tivat and Bay of Hercegovi) in annual cycle of intense investigations, as well as of shallow habitats convenient for mariculture. Former data on zooplankton for the Bay of Boka Kotorska are given in numerous papers which bring only scarce data on larvae. Data on fish roe and larvae for the Bay of Boka Kotorska are given by Gamulin (1954) and Merker, K. (1971). Zooplankton of the Bay of Boka Kotorska is a typical meroplanktonic community rich in various larval forms of pelagic and benthos organisms.

The objective of these investigations was to obtain an insight into the composition of meroplanktonic community and its place in zooplanktonic biocenose of the Bay of Boka Kotorska. The results of these investigations are relevant for defining, valorisation and protection of zooplanktonic biocenose biodiversity in littoral waters of South Adriatic.

2. MATERIALS AND METHODS

Our observations were based on the analysis of zooplankton samples collected monthly during 2010 on three shallow stations near the seafood farming areas (P-IBM, P-M, P-O) and 4 stations in the middle of each bay within Bay of Boka Kotorska: Bay of Kotor (P1), Bay of Risan (P2), Bay of Tivat (P3) and Bay of Hercegovi (P4). Zooplankton was collected with Nansen net (100 and 150 microns). In the same time, other factors were measured: T°C, Sal‰, pH, O₂, transparency by Secchi plate, color of the sea with Forel scale I-XXI.

¹Department of Biological Sciences, Faculty of Biology, State University Novi Pazar, Serbia veravukanic@yahoo.com ; vvukanic@np.ac.rs

²Sinop University Faculty of Fisheries; Marine Biology and Ecology Department, TR5700 Sinop, Turkey biologists@gmail.com

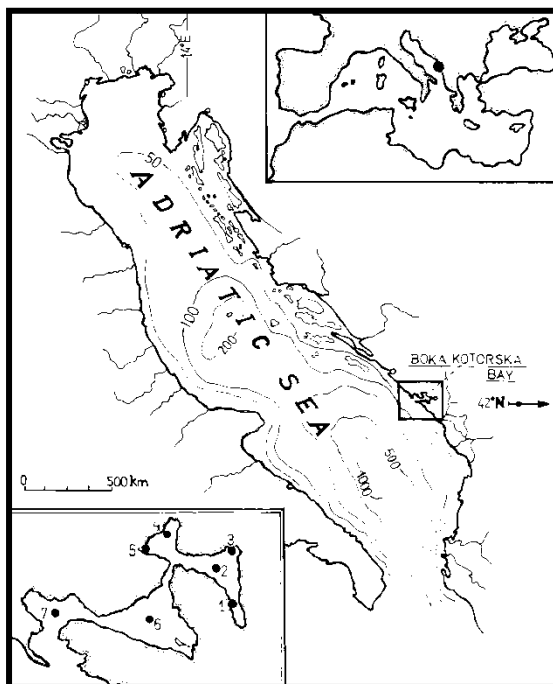

Figure 1. Map of sampling area in southern Adriatic [1: (P-IBM); 2: (P₁-K); 3: (P-O); 4: (P₂-R); 5: (P-M); 6: (P₃-T); 7: (P₄-HN)]

3. RESULTS AND DISCUSSION

Hydro-meteorological conditions of this area make an impact on anomalies in oscillation of ecological conditions in the Bay of Boka Kotorska. Temperature oscillations are clearly expressed. Minimal temperature was recorded in January (8.20°C) at the site P-IBM in the Bay of Kotor, whereas the maximal one was in July (28.60°C) also at the site P-IBM in the Bay of Kotor. According to former data the maximum in the surface layer of the sea totalled 29.00°C (Vukanic, D. *et al.* 1979).

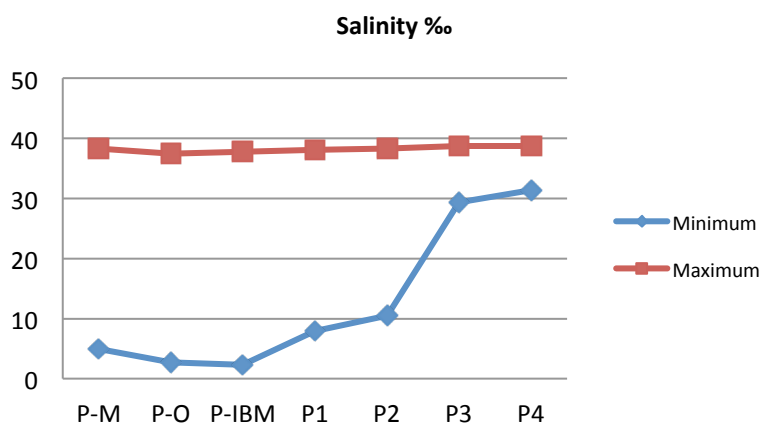

Figure 2. Variation of salinity at stations during 2010.

Salinity has a severely high variation in the surface layer of the sea, owing to the intake of fresh waters and precipitation in winter months. Maximal salinity totalled in March 37.80‰ at the site P-IBM, on depth of 10 m, in the Bay of Kotor, minimal one being recorded in November 2.70‰ at the site P-O, in surficial layer in the Bay of Kotor.

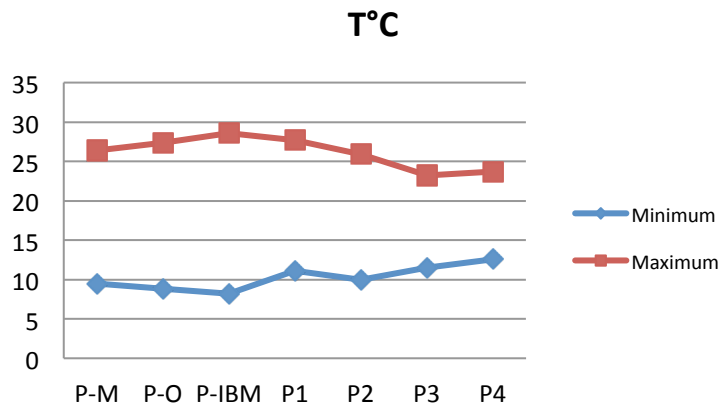

Figure 3. Variation of temperature at stations during 2010.

Our detailed investigations of network zooplankton also include the larvae from various groups of marine organisms thereof we present data for the Bay of Boka Kotorska. Their percentual participation as related to the total zooplankton rated for the Bay of Kotor 1%, Bay of Risan 25%, Bay of Tivat 4.99% and Bay of Hercegnovi 6.79%.

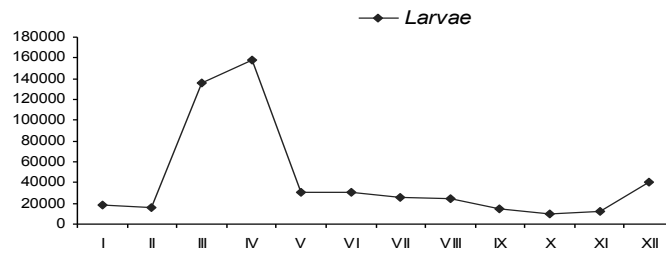

Figure 4. Quantitative fluctuation of the Larvae during the study

Nauplius stadia of copepods are organisms that are more or less segmented, slightly chitinous which in meroplankton make a dominant group of larvae. Here we present the data about their abundance and distribution in the Bay. They were numerously presented at all the sites with markedly increased abundance by the end of Winter and beginning of Spring. Their percentual participation as related to other larvae in plankton rated 46.7% for the Bay of Kotor, 82.6% for the Bay of Risan, 28.48% for Bay of Tivat and 22.7% for the Bay of Hercegnovi.

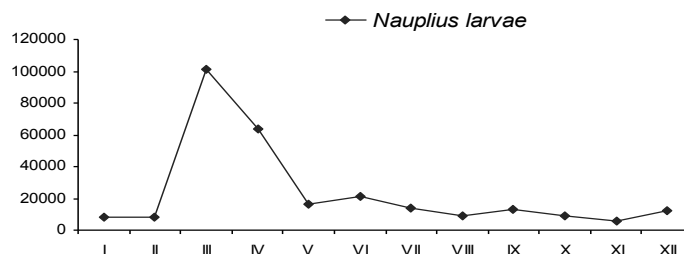

Figure 5. Quantitative fluctuation of the Nauplius larvae during the study

Larvae of crustacea compose a significant part of meroplankton community. Cirripedia larvae also have a relatively numerous participation in that community, and we present data on their abundance and distribution in the Bay. Their percentual participation as related to other larvae in plankton ranged for the Bay of Kotor 4.62%, the Bay of Risan 0.17%, Bay of Tivat 10.53% and Bay of Hercegnovi 1.54%.

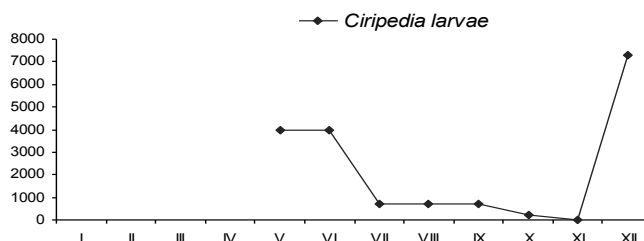

Figure 6. Quantitative fluctuation of the Cirripedia larvae during the study

Larvae of various types of decapods are present at all sites throughout the entire year, they were less numerous at deeper sites, and most numerous at the shallow ones along the shore. Data on abundance and distribution of decapod larvae in Adriatic are very scarce. The first qualitative-quantitative data are given by Kurian (1956), Vučetić (1957), Lučić (1985, 1998), Lučić & Bender-Pojatina (1995). Štević (1990) cites that the fauna of decapod crustaceans of Adriatic Sea is very rich and versatile, and it is frequently difficult to differ some larval stadia more precisely from the category of the genus or the family, what is confirmed by the most recent investigations of Adriatic Sea (Gullèen & Gras, 1995). Their percentual participation as related to other larvae in the plankton ranged for the Bay of Kotor 6.11%, Bay of Risan 0.35%, Bay of Tivat 11.04% and Bay of Hercegnovi 5.96%.

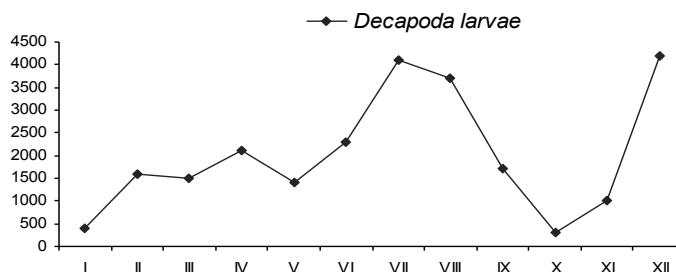

Figure 7. Quantitative fluctuation of the Decapoda larvae during the study

Larvae of Ophiuridae are very common in plankton, they occur throughout the entire year, most frequently larvae are from the genera: *Ophiothrix*, *Ophioglypha*, *Amphiura* etc. (Treguboff, G. & Rose, M., 1957). We present the first data for the Bay of Boka Kotorska about the occurrence, abundance and distribution of Ophiurida larvae. Their percentual participation as related to other larvae in plankton ranged for the Bay of Kotor 0.18%, Bay of Risan 0.29%, Bay of Tivat 4.01% and Bay of Hercegnovi 6.5%.

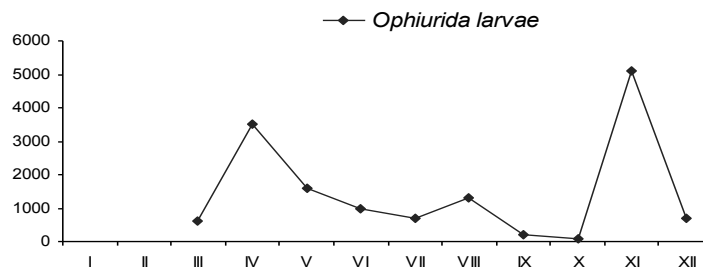

Figure 8. Quantitative fluctuation of the Ophiurida larvae during the study

We present the first data from the annual cycle of research on oscillations and abundance of juvenile *Mytilus galloprovincialis* L. in the Bay of Boka Kotorska. In our data for shallow habitats (P-IBM, P-O, P-M) in immediate proximity of culturing spot there occur markedly high values for abundance of juvenile *Mytilus galloprovincialis* L. from the end of February until the end of April. We record a maximum of numerosity at the end of April with percentual participation as related to the total zooplankton of 9.40% by the Institute, 12.20% by Orahovac and 5.55% by Morinj. In November, December and January we did not record any specimen, probably because of heavy rains and large intake of fresh waters into the Bay of Boka Kotorska what caused their going off and taking away from these habitats by the streams. We recorded high values for abundance of juvenile *Mytilus galloprovincialis* L. from the end of March to the end of April and at the central sites of all four bays. Maximal abundance at these sites also was found at the end of April, and their percentual participation as compared to the total zooplankton ranged 5.44% in the Bay of Kotor, 18.66% in the Bay of Risan, 3.85% in the Bay of Tivat, and 6.21% in the Bay of Hercegnovi. Increased values of number of individuals of this form were also recorded in July in the Bay of Hercegnovi (50300 ind/m²) and their percentual participation as related to the total zooplankton was 16.79%. The increase of abundance in November and December was stated in outer part of the Bay of Boka Kotorska. During the Autumn spawning (September - October) the Bay experiences the occurrence of very strong exit streams (3cm/sec) which take away a mass of larvae and juvenile specimens towards the Bay of Hercegnovi and the open sea; thus in the Bay of Hercegnovi we record average annual value of percentual participation in zooplankton of 61.89% of these forms. Percentual participation as related to other larvae in plankton ranged for the Bay of Kotor 39.07%, Bay of Risan 15.8%, Bay of Tivat 40.9% and Bay of Hercegnovi 61.89%.

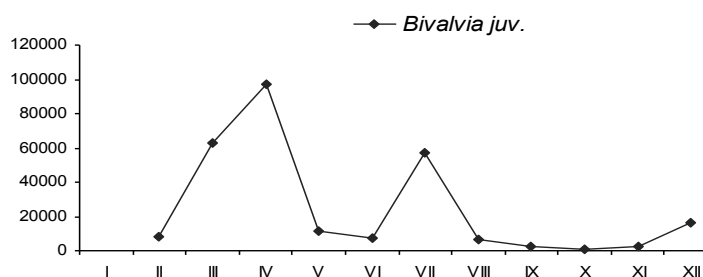

Figure 9. Quantitative fluctuation of the Bivalvia larvae during the study

Data on fish roe and larvae for the Bay of Boka Kotorska are given by Gamulin (1954) and Merker, K. (1971). They cite that spawning in the Bay is very poor and that it starts in October at average temperature of 19.40°C, and ends in March at average temperature of 13.85°C. Our data which are from the samples taken by a dense net (150µm) indicate poorness in number of roe and larvae with maximal abundance in August and lower one in April. Merker, K. (1971) cites that it is possible to assume that in this small place with low depth one cannot expect more numerous population of adult pilchard. Percentual participation as related to other larvae in the plankton ranged for the Bay of Kotor 0.55%, Bay of Risan 0.001%, Bay of Tivat 0.12% and Bay of Hercegnovi 0.23%.

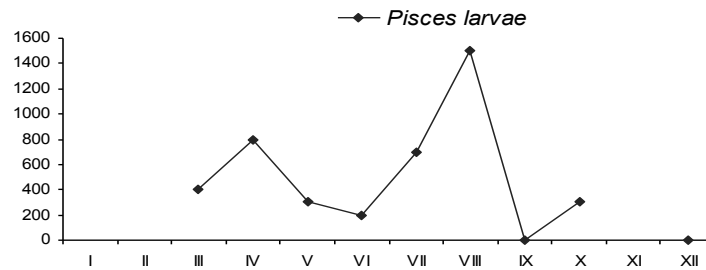

Figure 10. Quantitative fluctuation of the Pisces larvae during the study

Larvae of polychaeta occur almost continuously at all sites, somewhat more numerous during the Autumn and Winter. Percentual participation as related to other larvae in plankton ranged for the Bay of Kotor 10.37%, Bay of Risan 0.74%, Bay of Tivat 3.63% and Bay of Hercegovi 5.49%.

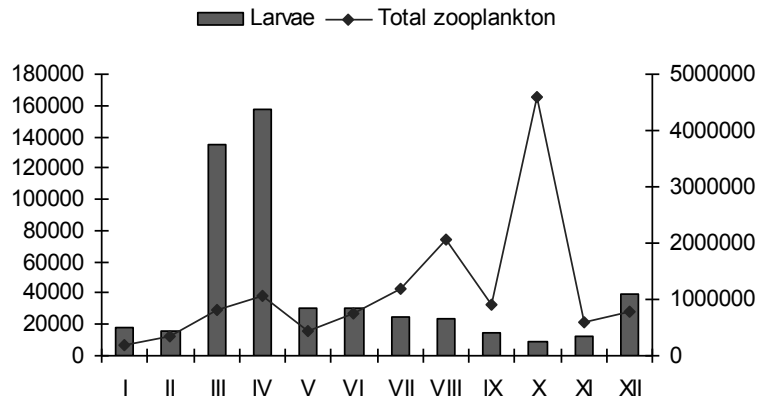

Figure 11. Fluctuations in abundance of zooplankton and larvae during the studied year in Bay of Boka Kotorska

Table 1. Larvae and pisces eggs found in investigation station in Bay of Boka Kotorska during 2010.

Stations	P-IBM	P-O	P-M	P ₁ -K	P ₂ -R	P ₃ -T	P ₄ -HN
Larvae							
Decapoda l.	+	+	+	+	+	+	+
Ophiurida l.	+	+	+	+	+	+	+
Echinida l.	+	+	+	+	+	+	+
Cirripedia l.	+	+	+	+	+	+	+
Bivalvia juv.	+	+	+	+	+	+	+
Bipinnaria l.		+	+				
Tornaria l.			+	+			+
Auricularia l.				+	+	+	+
Mitraria l.						+	
Nauplius l.	+	+	+	+	+	+	+
Pisces l.	+	+		+		+	
Pisces ova	+	+		+	+	+	+
Total	8	9	8	10	8	10	9

4. CONCLUSIONS

Waters of the Bay of Boka Kotorska have very marked oscillations of hydrographic properties and there are significant differences among the individual bays. In thermic respect the Bay of Boka Kotorska does not represent a homogenous area. The most marked oscillations are in surficial strata. Temperature maximum usually occurs in July or August, minimum in January or February. Data on temperature, salinity, saturation by oxygen which always ranged above 100%, pH, color of the sea and transparency have confirmed that the Bay of Boka Kotorska is markedly eutrophic area.

Abundant presence of larvae of various pelagic and benthos species of animals in plankton of the Bay of Boka Kotorska defines this community as a meroplanktonic one. The biomass of larvae has always been lower at the sites by the coast, with the exception of juvenile bivalvia and crustacea larvae, and more abundant in the middle of the bay. From April to June there was stated an increased abundance of juvenile Bivalvia of species *Mytilus galloprovincialis* L.. We recorded the highest percentual participation of planktonic larvae in the Bay of Risan.

REFERENCES

- [1] Gamulin, T., Mriješćenje i mrijestilišta sardele (*Sardina pilchardus* Walb.) u Jadranu 1947-50. Izvješća (biol. eksp. "Hvar" 1948-1949) IV(6) Split, 1954.
- [2] Kurian, C. V., Larvae of decapod crustacea from the Adriatic Sea. *Acta Adriatica*. VI(3)1-108, 1956.
- [3] Lučić, D., Day/night variation in mesozooplankton and macrozooplankton in the Mali Ston Bay. M.Sc. thesis,
- [4] Lučić, D. and Bender-Pojatina, A., Net zooplankton of Mljet Lakes. *Ekološke monografije*, 6:483-498, 1995.
- [5] Lučić, D., Annual variability of the decapod larvae community in the shallow waters of the southern Adriatic. *Acta Adriatica*. 39(1):25-30, 1998.
- [6] Merker, K., Neka preliminarna opažanja na pronalaženju lokaliteta mriješćenja sardele (*Sardina pilchardus* WALB.) na području Južnog Jadrana. *Studia Marina*. 5:61-71, 1971.
- [7] Števičič, Z., Check-list of the Adriatic decapod Crustacea. *Acta Adriatica*. 31:183-274, 1990.
- [8] Treguboff, G. and Rose, M., *Mauel de planctnologie Méditerranèenne*. C.N.R.S. Paris. I:580, 1957.
- [9] Vučetić, T., Zooplankton investigations in the sea Water lakes "Malo jezero" and "Veliko jezero" on the island of Mljet (1952-1953). *Acta Adriatica*. VI(4):1-51, 1957.
- [10] Vukanić, D., La recherches sur la Zooplanktons dans la baie de Kotor. *Nova Thalassia*. 3(1):249-255, 1979.
- [11] Vukanic, V., Zooplankton of the Boka Kotorska Bay – ekology, biodiversity, environment protection. Montenegrin Academy of Sciences and Arts, Spec.ed. (Monographies and Studies) Vol.96; The Section of Natural Sciences Vol.38, p.1-195, 2012.

Biography

PhD Vera Vukanic: is assistant professor on State University of Novi Pazar, Faculty of Biology, whose primary research interest is on marine zooplankton (Copepoda, Cladocera, Medusacea, Appendicularia, Chaetognatha, Decapoda larvae), Marine environment, Marine ecology and Taxonomy. She has written over 50 publications including peer-reviewed papers, book chapters and policy related reports and assessments.

Teaching courses on faculty of Biology: Biology of Invertebrate I and II, Hydrobiology, Zoology, Animal ecology, Essential ecology.

Integration of Photocatalytic and Membrane Distillation Hybrid Processes for Textile Wastewater Treatment

Nadir Dizge^{1*}, H. Cengiz Yatmaz², M. Sezen Kurt²

Abstract

In this study, the degradation of textile industry wastewater was investigated to obtain innovative integrated process of photocatalytic and membrane distillation processes. Photocatalytic oxidation was conducted with semiconductor ZnO catalysts (1 g/L) under UVA irradiation. For the next stage, hybrid design of membrane distillation and photocatalytic processes was performed sequentially. Initially the photocatalytic process was conducted for three hours at initial values of 140 mg/L COD and 1 g/L ZnO catalyst loading under UVA irradiation and then treated solution was run through the distillation module at 35 °C temperature and 665 mL/min flow rates. PVDF 0.22 µm membrane was used in the module. The result showed that decolorization of textile wastewater and catalyst recovery was carried out successfully at integrated system.

Keywords: Photocatalytic membrane distillation, textile wastewater treatment, ZnO catalyst, PVDF membrane

1. INTRODUCTION

Textile industry wastewater mainly contains high concentrations of hazardous chemicals and requires extensive treatment methods. Since the stringent imply of effluent discharge regulations, progress and improvement in recent research studies have led to develop advanced treatment systems by combining advance oxidation processes [1]. Photocatalysis as one of the major advanced oxidation processes received massive attention for water treatment in recent years [2-5]. TiO₂ has been widely used as semiconductor material for photocatalytic processes [6,7]. Membrane processes have also been applied extensively for the last decades as advanced treatment technologies [8,9].

Furthermore, photocatalytic and membrane processes have been combined as hybrid treatment systems and gained research attention broadly in recent years [10,11]. Coupling of membrane with photocatalysis has shown to be very powerful since a synergistic effect has been often observed. Membranes have been successful separating semiconductor powders and fouling on the membrane surface has been tremendously reduced and cleaned by the oxidation effect of photocatalytic processes. Therefore integrating these two processes has especially become a promising hybrid process [12,13]. The hybrid photocatalysis-membrane processes expanded the advantages related to its coupling with a membrane separation in photocatalytic membrane reactors (PMRs) [14,15]. Different configurations of PMRs have been utilized and characterized with photocatalyst immobilized on-in the membrane or catalyst in powder suspension. Permeate flux, membrane fouling and permeate quality have been investigated therefore advantages and disadvantages of the hybrid photocatalysis-membrane processes have been discussed [10,16].

The aim of this study is to develop an integrated treatment process involving photocatalytic reactor and membrane distillation in a sequential order using UVA emitting lamp module, ZnO semiconductor powder and PVDF membrane material. These processes were used in integrated order to achieve color and COD removal utilizing fabric dyeing wastewater from textile industry. The integrated process performance was followed up in bench-scale reactors to evaluate the long term performance of the hybrid system and to study the catalyst recycle potential.

2. MATERIALS AND METHODS

2.1. Chemicals and membranes

Selected properties of the fabric dyeing wastewater from textile industry were presented in Table 1.

¹Corresponding author: Mersin University, Department of Environmental Engineering, 33343, Mersin / Turkey.
ndizge@mersin.edu.tr

²Gebze Technical University, Department of Environmental Engineering, 41400, Gebze/Kocaeli, Turkey.
yatmaz@gtu.edu.tr

Table 1. Characterization of wastewater

Wastewater	pH	Conductivity ($\mu\text{S/cm}$)	COD (mg/L)	Color (525 nm)
Fabric dyeing	10.5	2300 \pm 85	200 \pm 15	1.107

Commercially pure ZnO (particle size <1 μm , Sigma–Aldrich) was used as semiconductor powder for photocatalytic experiments.

The polyvinylidene fluoride-PVDF hydrophobic microfiltration membrane with 0.22 μm pore size was obtained from Sterlitech. In each experiment, new membrane was used to obtain reproducible results.

2.2. Photocatalytic reactions and membrane distillation module

The photocatalytic reactions were performed in a laboratory scale column-shaped quartz photo-reactor. Further details of the reactor were given elsewhere [17]. Experimental setup of the sequential photocatalytic reactor and membrane distillation integrated process was given in Figure 1. During 120 minutes reaction time, samples were taken every hour and catalyst particles from the solution were separated by centrifugation. During the experiments the removal of organic material were observed with COD analyzes.

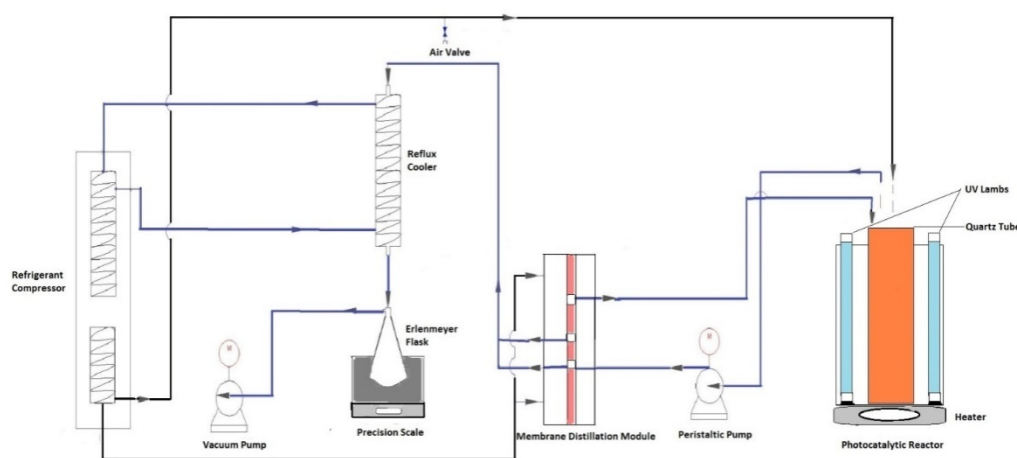

Figure 1. Experimental setup of the sequential photocatalytic reactor and membrane distillation integrated process

2.3. Analytical methods

The COD and color were measured according to standard methods [18]. Chemical solutions for the experiments were prepared with deionized water (Milli-Q® Ultrapure Water) having conductivity less than 18.2 $\mu\text{S/cm}$. pH and conductivity values were monitored by a pH and conductivity meter (Mettler Toledo).

The COD removal efficiency was determined as follows:

$$\text{Efficiency} = \frac{(C_o - C_t)}{C_o} \times 100 \quad (1)$$

where C_o and C_t are the COD concentration of feed and permeate, respectively.

3. RESULTS AND DISCUSSION

The optimization experiments in batch photocatalytic reactor showed that 200 mg/L initial COD concentration of wastewater was effectively treated when used 1 g/L ZnO catalyst loading and UVA lamps. Therefore, these conditions were used in photocatalytic vacuum membrane distillation (PVMD) hybrid reactor as the optimum values. Before the membrane distillation experiments, the photocatalytic experiments was conducted 60 min and pre-treated wastewater was sent membrane distillation unit. In the membrane distillation stage, PVDF (polivinildifloride) membrane type with 0.22 μm pore size was used. The distillate was collected through condenser and the collected distillate weight was measured versus time. Moreover, COD and conductivity values were measured in distillate.

Fabric dyeing wastewater total of 700 ml volume and 1 g/L ZnO catalyst were put inside the photocatalytic reactor and circulated membrane distillation module. The feed temperature was 35°C and the filtrate temperature was 5°C. Photocatalytic membrane distillation reactor was worked for 4 hours with flow rate of 665 mL/min. The COD and absorbance at three different wavelengths (436, 525, 620 nm) were measured in distillate. The wavelengths decreasing are shown in Figure 2. The absorbance at 436 nm decreased from 0.770 to 0.248. The absorbance value of 1.107 decreased to 0.133 at 525 nm wavelength and the absorbance decreased from 0.221 to 0.024 at 620 nm at the

end of 4 h. Moreover, the COD removal efficiency versus time was given in Figure 3. It can be clearly shown that the COD removal efficiency in distillate was 24% after 4 h.

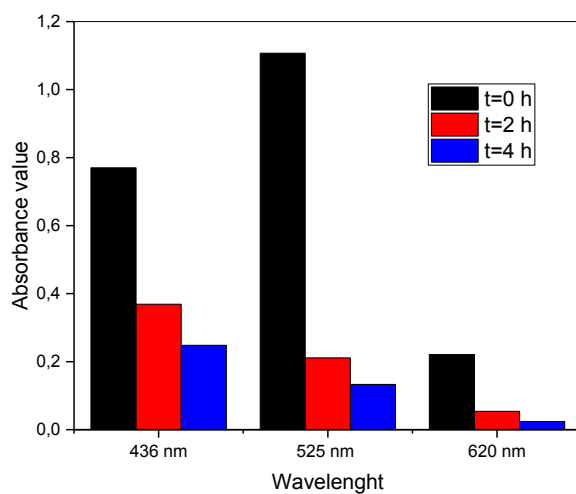

Figure 2. Absorbance value after 2 and 4 h (catalyst type: ZnO; catalyst loading: 1 g/L; light source: UVA; COD concentration: 200 mg/L; feed temperature: 35°C; permeate temperature: 5°C; flow rate: 665 mL/min)

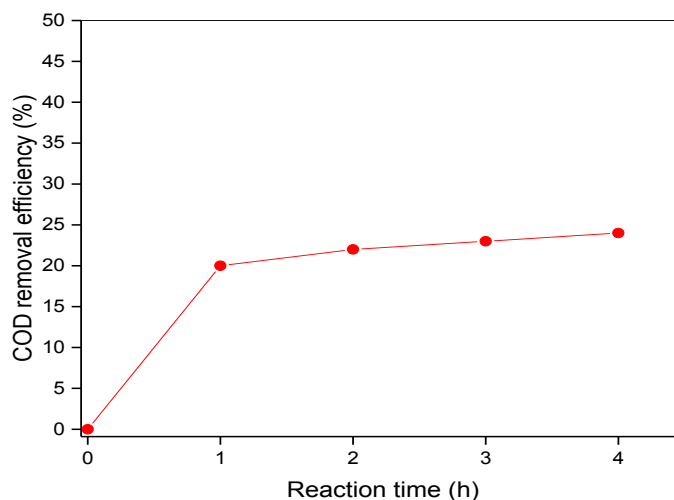

Figure 3. The COD removal efficiency versus time (catalyst type: ZnO; catalyst loading: 1 g/L; light source: UVA; COD concentration: 200 mg/L; feed temperature: 35°C; permeate temperature: 5°C; flow rate: 665 mL/min)

The distillate amount was also followed and presented in Figure 4. At the end of distillation, 87.6 g distillate was collected from PVDF 0.22 μm membrane at 665 mL/min flow rates.

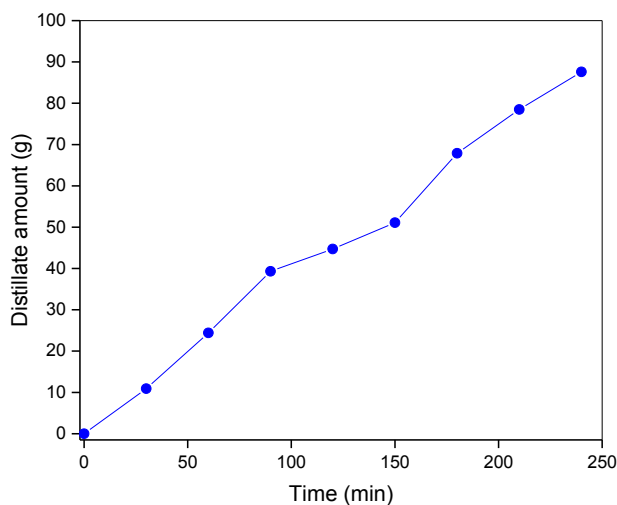

Figure 4. The effect of membrane pore size on (a) the distillate amount and (b) COD removal efficiency of RR 180 dye (catalyst type: ZnO; catalyst loading: 1 g/L; light source: UVA; dye concentration: 100 mg/L; feed temperature: 40°C; permeate temperature: 5°C; membrane type: flow rates: 665 mL/min)

4. CONCLUSIONS

A novel hybrid treatment system was developed for treatment reactive dyes used in textile industry. Photocatalytic reactor and membrane distillation were used as sequencing and hybrid system. Membrane distillation unit was connected to the photocatalytic reactor to achieve further treatment. Using membrane distillation to separate the catalyst particles provided ease of operation while maintaining a small footprint. Integrating membrane distillation unit after the photocatalysis process improved the color removal efficiency up to 90% for fabric dyeing wastewater. However, 24% COD removal efficiency was obtained in distillate after 4 h.

ACKNOWLEDGMENT

The authors thank The Scientific and Technological Research Council of Turkey (TUBITAK) for their financial support [Project number: 112Y223].

REFERENCES

- [1]. J. O. Tijani, O. O. Fatoba, G. Madzivire, L. F. Petrik, A Review of Combined Advanced Oxidation Technologies for the Removal of Organic Pollutants from Water, *Water Air Soil Pollut.* 225:2102 (2014) 1-30
- [2]. M. R. Hoffmann, S. T. Martin, W. Choi, and D. W. Bahnemann, Environmental Applications of Semiconductor Photocatalysis, *Chem. Rev.* 95 (1995) 69-96
- [3]. M. Kaneko, I. Okura, Photocatalysis: Science and Technology, Springer-Verlag, Japan, 2002
- [4]. U. Gaya, Heterogeneous Photocatalysis Using Inorganic Semiconductor Solids, Springer, Netherlands, 2014
- [5]. H. Kisch, Semiconductor Photocatalysis – Principles and Applications, Wiley-VCH, Weinheim, Germany, 2015
- [6]. K. Nakata, A. Fujishima, TiO₂ photocatalysis: Design and applications, *J. Photochem. Photobiol. C*, 13 (2012) 169–189
- [7]. M. N. Chong, B. Jin, C. W. K. Chow, C. Saint, Recent developments in photocatalytic water treatment technology: A review, *Water Research*, 44 (2010) 2997-3027
- [8]. R. Singh, Membrane Technology and Engineering for Water Purification; Application, Systems Design and Operation, Butterworth Heinemann, Colorado Springs, USA, 2014
- [9]. A. Basile, A. Cassano, N. K. Rastogi, Advances in Membrane Technologies for Water Treatment: Materials, Processes and Applications, Woodhead Publishing, 2015
- [10]. R. Molinari, A. Caruso, L. Palmisano, Comprehensive Membrane Science and Engineering, Volume 3.07: Photocatalytic Processes in Membrane Reactors, Newnes, 2010
- [11]. V. Loddo, L. Palmisano, T. Marino, R. Molinari, Advanced Membrane Science and Technology for Sustainable Energy and Environmental Applications, Volume 23: Membranes for photocatalysis in water and wastewater treatment, Woodhead Publishing, 2011
- [12]. R. A. Damodar, S. You, S. Ou, Coupling of membrane separation with photocatalytic slurry reactor for advanced dye wastewater treatment, *Separation and Purification Technology*, 76 (2010) 64–71
- [13]. S. O. Ganiyu, E. D. van Hullebusch, M. Cretin, G. Esposito, M. A. Oturan, Coupling of membrane filtration and advanced oxidation processes for removal of pharmaceutical residues: A critical review, *Separation and Purification Technology* 156 (2015) 891–914
- [14]. R. Molinari, P. Argurio, L. Palmisano, Advances in Membrane Technologies for Water Treatment, Volume 7: Photocatalytic membrane reactors for water treatment, Woodhead Publishing, 2015

- [15]. S. Mozia, A.W. Morawski, R. Molinari, L. Palmisano, V. Loddo, Handbook of Membrane Reactors: Reactor Types and Industrial Applications, Volume 6: Photocatalytic membrane reactors: fundamentals, membrane materials and operational issues, Woodhead Publishing, 2013
- [16]. S. Mozia, Photocatalytic membrane reactors (PMRs) in water and wastewater treatment, *Separation and Purification Technology* 73 (2010) 71–91
- [17]. M. Tekbas, H.C. Yatmaz, N.Bektas, *Microporous and Mesoporous Materials* 115 (2008) 594–602
- [18]. E.W. Rice, R.B. Baird, A.D. Eaton, L.S. Clesceri, APHA, Standard methods for the examination of water and wastewater (2012)

BIOGRAPHY



Nadir Dizge was born in Tarsus, Turkey, in 1978. He received the B.E. degree in environmental engineering from the University of Mersin, Turkey, in 2002, and the M. Tech. and Ph. D. degrees in environmental engineering from the Gebze Institute of Technology (GIT), Kocaeli, Turkey, in 2006 and 2011, respectively. In 2004, he joined the Department of Environmental Engineering, University of GIT, as a Research Assistant. Since 2014, he has been with the Department of Environmental Engineering, Mersin University, where he was an Assistant Professor, and became an Associate Professor in 2014. His current research interests include membrane processes, adsorption, ion-exchange, biological treatment process, and nanoparticles.

Ecotoxicological Investigation of Three Nano-metal Oxides (HfO₂, SiO₂, ZnO) on Four Trophic Levels (Bacteria, Yeast, Mold and Algae) and their Biodegradabilities

Nefise Erdincmer¹, Delia Teresa Sponza²

Abstract

Nano-metal oxides (NMOs) are used in very large scale in industrial applications, in electronics, in textiles and in water treatment technologies. This results with accumulation of these NMOs in the nature and cause to toxicity in the ecosystem. Knowledge of potential toxicity of nanoparticles to organisms is limited. To determine the toxicological effects of nano-HfO₂; nano-SiO₂; nano-ZnO to anaerobic methane Archaea from bacteria, to *Candida albicans* from yeast, to *Aspergillus niger* from mold, to *Chlorella sp.* from blue-green algae; some toxicity analyses were performed to detect the EC₅₀ values (nanoparticle concentration inhibiting 50 % of the organisms). These values were calculated from the inhibitions of NMOs versus exposure time (24, 48 and 72 hours). Among the nanoparticles, the most toxic NMO was found to be nano-ZnO to algae – *Chlorella sp.* because of the low EC₅₀ values after 48 hours contacting time (0,55 mg/l). Anaerobic methane Archaea bacteria are very sensitive to nano-HfO₂ (48-h EC₅₀=13,55 mg/l) due to low EC₅₀ values compared to other NMOs. *Candida albicans* and *Aspergillus niger* were sensitive to nano-ZnO even at low concentrations due to low EC₅₀ values (48-h EC₅₀=17,5 mg/l for *Candida albicans*; 48-h EC₅₀=13,9 mg/l for *Aspergillus niger*). *Chlorella sp.* is very sensitive to all NMOs (nano-HfO₂ EC₅₀= 2,4 mg/l; nano-SiO₂ EC₅₀= 0,86 mg/l and nano-ZnO EC₅₀=0,55 mg/l) due to entrapment of NMOs by the algal cells resulting in inhibitions. Among the three NMOs, the most acute toxic and the less acute toxic nanoparticle were nano-ZnO and nano-HfO₂, respectively. The most sensitive organism was algae - *Chlorella sp.* while the most resistant organism was found to be yeast – *Candida albicans*. From the 28 days biodegradability tests of NMOs it was found that the percentage of removal efficiencies are 19,01 %, 34,34 % and 6,43 % for nano-HfO₂, nano-SiO₂ and nano-ZnO, respectively after 28 days.

Keywords: Nano-metal oxides, Trophic levels, Acute toxicity, Biodegradability

1. INTRODUCTION

Nanoparticles (NP) are structures with dimensions generally between 1 to 100 nm. There are widespread in nature. Different sizes, different structures, one-element or multi-element structure can be formed in different shapes and formats, or desired. NPs have wide potential: in the short term in the textile, cosmetics and dye, in the long-term medications are used in drug delivery systems to send the requested body [1]. Also NMO is widely used in the treatment of industrial wastewater [2], [3]. This widespread production and use of nanoparticles in nature means intense accumulation. NMOs because of can easily be synthesized chemically and can easily be modified consumer products; industrial products, machinery industry, military applications, in wastewater treatment and medicine widely used [4]. In particular, the development of wastewater treatment technology that uses NP is seen as an alternative solution to the growing worldwide water pollution problems. Examples of this work in the treatment of heavy metals; nano zinc oxide were used for the removal of copper from industrial waste water and the maximum adsorption capacity obtained for nano-ZnO are 226 mg/g [5]. Among the inorganic oxide NPs, silica (SiO₂), is among the most commonly utilized NMOs, and this oxide included in the Organization for Economic Cooperation and Development's (OECD) priority list of NMOs requiring urgent testing for human health and environmental safety [6]. Hafnium oxide (HfO₂) is a suitable replacement for silicon oxide. HfO₂ has a dielectric constant of about 14, compared to silicon oxide with a dielectric constant of 3.9 [7]. Studies about the environmental toxicity of these NMOs is very limited. The most commonly used Nano-ZnO creates high toxicity on bacteria (EC₅₀ value for *E. coli*: 0,048 mg/l). Zinc ions (Zn²⁺) connect to bacterial cells and reported that damage to physiological function of the defeated cell to osmotic shock [8].

In this study the effects of increasing nano-SiO₂, nano-HfO₂ and nano-ZnO concentrations (from 0.01 mg/l to 100 mg/l) were studied on three trophic levels (bacteria, fungus, algae) and some toxicity analyses were performed to detect the EC₅₀ values (nanoparticle concentration inhibiting 50 % of the organisms). Furthermore, their

¹ Corresponding author: Dokuz Eylul University, Engineering Faculty, Environmental Engineering Department, Buca Kaynaklar Campus, 35160 Tinaztepe, Izmir, Turkey. nefiseerdincmer@gmail.com; nefise.erdincmer@deu.edu.tr

² Dokuz Eylul University, Engineering Faculty, Environmental Engineering Department, Buca Kaynaklar Campus, 35160 Tinaztepe, Izmir, Turkey. delia.sponza@deu.edu.tr

biodegradability tests were determined in an aquatic environment during 28 days based on the soluble COD concentrations.

2. MATERIALS AND METHODS

2.1. Properties and Preparation of NMOs

The environmental toxicity of nanoparticles was studied using three different NMOs. These nanoparticles are nano-ZnO (abcr, AB249229, Lot:1235097) ; nano-SiO₂ (Sigma-Aldrich, 637238, Lot:MKBL8542V) and nano-HfO₂ (Sigma-Aldrich, 202118, Lot:MKBH3310V). The ranges of studied nanoparticles concentrations were determined by considering the acute toxicity test in the recent literature. NMOs were suspended in deionized water at 100 mg/l. In order to improve the dispersion of NPs, suspensions were sonicated for 60 min at sonicator. Then serial dilutions (10⁻¹, 10⁻², 10⁻³, 10⁻⁴) were prepared to obtain a range of concentrations for further toxicity testing. The diameter of nano-SiO₂, nano-HfO₂ and nano-ZnOs were 10-20 nm, 5-7 nm, and 10-30 nm, respectively.

2.2. Toxicity Tests

2.2.1. Anaerobic Toxicity Test (ATA)

Anaerobic toxicity assays (ATA) were performed at 35°C at volume of 150 ml amber bottle reactors [9]. Anaerobic sludge used for this test was obtained from Pakmaya Baker's Yeast Producing Factory(Izmir) providing 3000 mg/l anaerobic VSS (volatile suspended solids) concentration. Vanderbilt Mineral Medium containing 3000 mg/l glucose-COD, 30 ml sodium thioglycollate (to maintain the anaerobic environment) and 5 ml NaHCO₃ (to keep the neutral pH) were added into a sterile 5 Liter flask (A solution). 1 ; 5 ; 10 ; 25 ; 50 and 100 mg/l NMOs concentrations were added into the amber bottle reactors. 75 ml from A solution were distributed to each bottle reactor and they were stirred in a sonicator for 1 hour. 40 mg/l of the anaerobic sludge containing 750 mg/l anaerobic VSS was added and the mouths of the bottles were sealed with rubber stoppers. Before the toxicity experiments, serum bottles were operated until the variation in daily gas production was less than 15% for at least 2 days. After 24 and 48 hours incubation period the methane gas was measured by passing the gas in the bottles from a solution containing 3 % NaOH solution by liquid displacement method [10]. Methane gas production of the samples containing NMOs and the control groups was determined and the degree of inhibition effect on anaerobic Archaea was calculated by comparison with the control samples and test groups. This inhibition was defined as a decrease in methane gas compared to the control samples.

2.2.2. Yeast and Mold Acute Toxicity Tests

Candida albicans from yeast and *Aspergillus niger* from mold were studied to determine the toxic effect of used NMOs. Reference cultures were purchased from Public Health Agency of Turkey. First of all, lyophilized cultures were incubated in Tryptic Soy Broth (Merck) during 4 hour at 30 °C for both organisms, then they were transferred by pour plate technique to petri plates containing Potato Dextrose Agar (BD Difco) and they were incubated during 72 hours at 30 °C. When the organisms are in log phase (5x10⁻⁵ cfu/ml for *Candida albicans* – 1x10⁻⁵ cfu/ml for *Aspergillus niger*), the acute toxicity of NMOs were performed. NMOs stock solutions (100 mg/l) were sonicated during 60 min. From the stock NMO solutions serial dilutions were performed. 5 ml of the different NMOs dilutions and 1 ml of *Candida albicans* and *Aspergillus niger* culture staying in log phase (5x10⁻⁵ cfu/ml for *Candida albicans* – 1x10⁻⁵ cfu/ml for *Aspergillus niger*) were placed on the steril tubes and they were incubated during 24 h and 48 h at 35 °C temperature. The numbers of yeast and mold were enumerated and compared with control groups containing no NMOs. From the inhibition percentages of the organisms, the values affecting the 50 % of the *C.albicans* and *A.niger* were accepted as EC₅₀ values.

2.2.3. Freshwater Algae Growth Inhibition Test

The purpose of this test is to determine the toxic effect of MNOs on the growth of fresh water algae (*Chlorella sp.*) according to OECD 201 [11]. The medium used to growth of *Chlorella sp.* is AAP-Medium and TG-201 Medium and it was incubated at 25 °C temperature. The initial algal cell concentrations in the test cultures was 2x10⁴ cells/ml. Exponentially growth test organisms are exposed to the NMOs in batch cultures over a period of 72 hours. First of all, NMOs stock solutions (0.01 ; 0.25 ; 0.5 ; 1 and 5 mg/l) were prepared and sonicated before used and NMOs were added to the 50 ml TG-201 Medium. All tests solutions (NMOs and algal cells) must contain the same concentrations of growth medium and initial biomass of test algae and algal cells were exposed during 24, 48 and 72 hours at 21 °C temperature. Average growth rate inhibition was calculated from the following equation : [I % = (1- N/N₀) X 100] ; (N is the number of algal cells exposed to NMOs/10 µl ; N₀ is the number of algal cells in the control group/10 µl and I % is the average growth rate inhibition) [11,12]. From the average specific growth rates recorded in a series of test solutions, the concentration bringing about a specified x % inhibition of growth rate (50 %) is determined and expressed as the EC (EC₅₀) [11].

2.2.4. Biodegradability Test

This method evaluate the biodegradability of NMOs in activated sludge (AS) according to OECD 314 [13]. Before studies, room temperature was adjusted 21 °C. NMOs solutions were prepared (10 mg/2 liter and 100 mg/2 liter) and sonicated during 60 minutes. This 2-liter solutions were transferred to glass reactors with volumes of 2000 ml and they were added 50 mg/l suspended solids (SS) containing aerobic sludge, 10 mg/l and 100 mg/l glucose-COD, separately. pH and dissolved oxygen (DS) were adjusted as 7 and 4 mg/l, respectively. Then it was started to the test. The soluble-COD values were measured for each NMOs in 5th, 10th, 15th, 20th and 28th days. Each NMOs of removal efficiencies were calculated by comparison with the COD value at 0th day.

2.3. Statistical Analyses

The acute toxicity of NMOs to organisms with increasing doses has been studied by the statistical analysis of inhibitor of organisms whether it is time-dependent or dose-dependent. The relationships between the variables of time and inhibition percentages were investigated with multiple regression analysis using the ANOVA program (JMP 10). r^2 and p (<0.05) parameters were used to describe the statistical significance between dependent and independent variables.

3. RESULTS AND DISCUSSION

3.1. Results of Anaerobic Toxicity Assay (ATA)

ATA test based on methane production during 24 h and 48 h incubation periods were performed. In this test methane production of each assay bottle were measured and percent inhibition were calculated compared to control groups containing no NMOs. As seen in Table 1, the ATA tests results show that increasing of NMOs concentrations cause toxic effect to methane productions from the anaerobic Archaea. After 24 hour incubation period, Nano-HfO₂ showed low toxicity ($I=6.6\%$) to anaerobic methane Archaea at low concentration (1 mg/l nano-HfO₂) (Table 1). But at the same incubation period, when NMO doses were increased (from 5 mg/l to 100 mg/l), inhibition percentages also increased from 19.4 % to 87.8 % (Table 1). Likewise, while NMOs concentrations and exposure time were increased after 48 h, resistance of organism to nano-HfO₂ decreased. Nano-SiO₂ concentrations were up to from 1 mg/l to 100 mg/l, methane gas productions were decreased from 11.2 ml to 4.1 ml and were inhibited from 42.3 % to 78.9 % compared to the control group (Table 1). The inhibition of 1, 5, 10, 25, 50 and 100 mg/l nano-SiO₂ on methane production were 42.3 %, 44.3 %, 67.1 %, 70.1 %, 75.3 % and 78.9 % after 48 h exposure time, respectively. Nano-ZnO is the most toxic NMOs because when methane Archaea bacteria exposed to the maximum nano-ZnO concentrations of 100 mg/l since all Archaea were died and they could not produce methane gas after 48 h incubation time (Table 1). Nano-SiO₂ and nano-ZnO caused high toxicity to methane gas generation at 50 and 100 mg/l dose after 24 h and 48 h (Table 1). Beside after 24 h nano-HfO₂ and nano-ZnO caused low toxicity to anaerobic Archaea at low concentrations (1 mg/l nano-HfO₂ : 6.6 % inhibition ; 1 mg/l nano-ZnO : 12.6 % inhibition). NMOs were low toxic to anaerobic methane Archaea at low concentrations (Table 1). ANOVA tests statistics for anaerobic toxicity assay (ATA) tests revealed that there is a linear relationship between NMOs concentrations and incubation period (for nano-ZnO, $R_{\text{square}}=0.095$; for nano-HfO₂, $R_{\text{square}}=0.095$; for nano-SiO₂, $R_{\text{square}}=0.92$). It was found that regression analysis between time (for nano-ZnO, $p=0,0019 < 0,05$; for nano-HfO₂, $p=0,0119 < 0,05$; for nano-SiO₂, $p=0,0143 < 0,05$) and doses (for nano-ZnO, $p=0,0001 < 0,05$; for nano-HfO₂, $p=0,0003 < 0,05$; for nano-SiO₂, $p=0,0101 < 0,05$) was significant as a results of ANOVA tests ($\alpha=0,05$).

Table 1. Methane production and inhibition percentages of anaerobic Archaea after exposed to NMOs during 24 h and 48 h

NMOs Concentrations (mg/l)	Nano-SiO ₂				Nano-HfO ₂				Nano-ZnO			
	24 h		48 h		24 h		48 h		24 h		48 h	
	CH ₄ g (ml) *	I (%)**	CH ₄ g (ml)	I (%)	CH ₄ g (ml)	I (%)	CH ₄ g (ml)	I (%)	CH ₄ g (ml)	I (%)	CH ₄ g (ml)	I (%)
Control Group	19.4	0	23.6	0	18	0	19,2	0	15	0	16	-
1 mg/l	11.2	42.3	13.4	43.2	16.8	6.6	13,1	31.8	14.1	12.6	13.8	13.75
5 mg/l	10.8	44.3	11.6	50.8	14.5	19.4	12,9	32.8	10.2	32	8.4	47.5
10 mg/l	6.4	67	10.3	56.4	13.1	27.2	9,7	49.5	6.2	58.7	4.3	73.1
25 mg/l	5.8	70.1	3.2	86.4	5.9	67.2	4,6	76.04	4.1	72.6	2.3	85.6
50 mg/l	4.8	75.3	1.6	93.22	4.1	77.2	3	84.4	2.5	83.3	1.9	85.1
100 mg/l	4.1	78.9	0.5	97.9	2.2	87.8	1,6	91.7	1.2	92	0	100

[* CH₄ g : Methane gas (ml) **I (%) : Inhibition percentages (%)]

Among the NMOs used it was found that nano-ZnO at all concentrations reduced the methane gas production significantly and cause to the high inhibition. Nguyen et al (2015) found that nano-ZnO at 240 mg/l inhibits the methane production by 74 % [14]. In this study, at 100 mg/l nano-ZnO concentration, after 24 h exposure time biogas production was inhibited by 92 % and we was not measured the methane gas after 48 h. Adsorption of nanoparticles to organic substance, precipitation of nanoparticles, or changes in surface charge are example of environmental influences that affect the toxicity of NMOs [15]. The study performed by Mu et al., (2011) showed 22.8 % and 81.1 % methane gas inhibitors at 100 mg/l nano-ZnO containing 30 and 150 mg/g-TSS [16]. The released Zn⁺² from nano-ZnO was an important reason for its inhibition. Furthermore, it was reported that the metabolic intermediates and key enzyme activities in sludge hydrolysis, acidification and methanation were inhibited by nano-ZnO [16].

3.2. Effect of NMOs to Yeast – *Candida albicans* and Mold – *Aspergillus niger*

Acute toxicity studies of the NMOs was evaluated by their EC₅₀ (effective concentration affecting the 50 % of the organisms) values on the studied yeast – *Candida albicans* and mold - *Aspergillus niger* at increasing NMOs doses (from 1 mg/l to 100 mg/l). First of all, Yeast – *C.albicans* colonies were exposed to increasing NMOs concentrations (1 mg/l ; 10 mg/l ; 50 mg/l and 100 mg/l) during 24 h and 48 h. After incubation period, numbers of yeast were enumerated and were calculated as percent inhibition compared to the control groups. Table 2 exhibited that as the NMOs concentrations were increased from 1 to 100 mg/l, high toxicity were detected for nano-HfO₂ and nano-ZnO studies. When the numbers of colonies were 156x10⁻³ cfu/ml at the control groups, yeast colonies decreased from 135x10⁻³ cfu/ml to 48x10⁻³ cfu/ml at 1 mg/l nano-ZnO up to 100 mg/l nano-ZnO concentrations after 24 hours (Table 2). The toxicity of nano-ZnO nanoparticles was increased as incubation period was up to 48 hours and percent inhibition was up to 97.5 % from 69.2 % at 100 mg/l nano-ZnO concentration (Table 2). On the contrary to nano-ZnO acute toxicity studies, nano-SiO₂ showed low toxicity to yeast cells at low concentrations (1 mg/l) after 24 h (1.2 %) and 48 h (6.5 %) exposure time. Both Nano-ZnO and nano-HfO₂ were more toxic than nano-SiO₂ because of high inhibition percentages of each incubation period (24 h and 48 h). At the maximum NMO concentrations (100 mg/l), inhibition percentages of nano-ZnO, nano-HfO₂ and nano-SiO₂ were 65.2 %, 92.1 and 97.5 % after 48 hours, respectively. ANOVA tests statistics for yeast – *Candida albicans* acute toxicity tests revealed that there is a linear relationship between NMOs concentrations and incubation period (for nano-ZnO, Rsquare=0.996 ; for nano-HfO₂, Rsquare=0.982 ; for nano-SiO₂, Rsquare=0.991). It was found that regression analysis between time (for nano-ZnO, p=0,0005< 0,05 ; for nano-HfO₂, p=0,0145< 0,05 ; for nano-SiO₂, p=0,0185< 0,05) and doses (for nano-ZnO, p=0,0004< 0,05 ; for nano-HfO₂, p=0,0052< 0,05 ; for nano-SiO₂, p=0,0013< 0,05) was significant as a results of ANOVA tests (α=0,05).

Table 2. The number of *Candida albicans* colonies after 24 h and 48 h exposed to NMOs

	Nano-SiO ₂				Nano-HfO ₂				Nano-ZnO			
	24 h		48 h		24 h		48 h		24 h		48 h	
	cfu/ml	I (%)	cfu/ml	I (%)	cfu/ml	I (%)	cfu/ml	I (%)	cfu/ml	I (%)	cfu/ml	I (%)
Control	345000	0	353000	0	210000	0	265000	0	156000	0	165000	0
1 mg/l	341000	1.2	330000	6.5	164000	21.9	146000	44.9	135000	13.5	106000	35.7
10 mg/l	270000	21.7	250000	29.2	110000	47.6	77000	70.9	114000	26.9	72000	56.4
50 mg/l	230000	33.3	192000	45.6	60000	71.4	48000	81.8	73000	53.2	36000	78.2
100 mg/l	170000	50.7	123000	65.2	43000	79.5	21000	92.1	48000	69.2	4000	97.5

The EC₅₀ values are given in Table 3. The EC₅₀ values of nano-SiO₂ were higher than other NMOs (nano-ZnO and nano-HfO₂) because of more resistant to nano-SiO₂ (EC₅₀=92.7 mg/l for 24 h ; EC₅₀=67.2 mg/l for 48 h). The EC₅₀ values of nano-HfO₂ for yeast - *C. albicans* were 41.1 mg/l for 24 h exposure time and 19.7 mg/l for 48 h exposure time, respectively (Table 3). The maximum acute toxicity was observed at nano-ZnO acute toxicity studies as a result of the EC₅₀ values of nano-ZnO were minimum (EC₅₀= 17.5 mg/l) for 48 h incubation period. Low EC₅₀ values indicates the sensitivity of organism to the increasing NMOs concentrations.

Table 3. EC₅₀ values of yeast – *Candida albicans*, mold – *Aspergillus niger* and Algae *Chlorella sp.* after exposure 24 h, 48 h and 72 h

		Nano-SiO ₂ EC (mg/l)	Nano-HfO ₂ EC (mg/l)	Nano-ZnO EC (mg/l)
Yeast – <i>Candida albicans</i>	24 h	EC ₅₀ = 92.7	EC ₅₀ = 41.1	EC ₅₀ = 59.5
	48 h	EC ₅₀ = 67.2	EC ₅₀ = 19.7	EC ₅₀ = 17.5
Mold – <i>Aspergillus niger</i>	24 h	EC ₅₀ = 18.03	EC ₅₀ = 27.8	EC ₅₀ = 25.9
	48 h	EC ₅₀ = 14.6	EC ₅₀ = 18.4	EC ₅₀ = 13.9
Algae – <i>Chlorella sp.</i>	72 h	EC ₅₀ = 0.86	EC ₅₀ = 2.94	EC ₅₀ = 0.55

Table 4 showed the number of mold – *A.niger* colonies after 24 h and 48 h exposure to NMOs. After incubation period, the increasing of NMOs concentrations were significantly affected the mold - *A.niger* colonies and high toxicity was observed. At minimum concentration (1mg/l NMOs), *A.niger* colonies were inhibited almost 50 % for each NMOs (for nano-SiO₂ : 50.1 %, for nano-HfO₂ : 51.7 % and for nano-ZnO : 50.8 % after 48 h) (Table 4). Furthermore mold colonies were almost died at the maximum concentrations (100 mg/l NMOs) for nano-SiO₂ and nano-HfO₂ and their percent inhibitions were 98.8 % and 96.8 %, respectively. Nano-ZnO was the most toxic and mold colonies were killed by nano-ZnO at 100 mg/l concentration during 48 hour (Table 4). ANOVA tests statistics for mold – *Aspergillus niger* acute toxicity test revealed that there is a linear relationship between NMOs concentrations and incubation period (for nano-ZnO, Rsquare=0.971 ; for nano-HfO₂, Rsquare=0.992 ; for nano-SiO₂, Rsquare=0.993). It was found that regression analysis between time (for nano-ZnO, p=0,0115< 0,05 ; for nano-

HfO₂, p=0,0251 < 0,05 ; for nano-SiO₂, p=0,01766 < 0,05) and doses (for nano-ZnO, p=0,0087 < 0,05 ; for nano-HfO₂, p=0,0011 < 0,05 ; for nano-SiO₂, p=0,0009 < 0,05) was significant as a results of ANOVA tests ($\alpha=0,05$).

As seen from the Table 3 shows that the EC₅₀ values of mold – *A.niger* were lower than that EC₅₀ values of yeast – *C.albicans*. After 24 h exposure time, the EC₅₀ values of nano-SiO₂, nano-HfO₂ and nano-ZnO were 18.03 mg/l, 27.8 mg/l and 25.9 mg/l, respectively. When the exposure time was up to 48 hour, EC₅₀ values of nano-SiO₂, nano-HfO₂ and nano-ZnO were 14.6 mg/l, 18.4 mg/l and 13.9 mg/l, respectively. In the comparison of to the EC₅₀ values of yeast - *Candida albicans* and mold – *Aspergillus niger*, it was found that *Aspergillus niger* was more sensitive than *Candida albicans*. Furthermore, nano-ZnO mostly affected both yeast – *C.albicans* and mold- *A.niger*. In other words *C.albicans* and *A.niger* influenced by high nano-ZnO concentrations with low EC₅₀ values of 17.5 mg/l and 13.9 mg/l after 48 h, respectively. Between all NMOs, the least toxic nanoparticle was nano-SiO₂ for *C.albicans* because of high EC₅₀ values after 48 h incubation period (48 h – EC₅₀=67.2 mg/l).

Table 4. The number of *Aspergillus niger* colonies after 24 h and 48 h exposed to NMOs

	Nano-SiO ₂				Nano-HfO ₂				Nano-ZnO			
	24 h		48 h		24 h		48 h		24 h		48 h	
	cfu/ml	I (%)	cfu/ml	I (%)	cfu/ml	I (%)	cfu/ml	I (%)	cfu/ml	I (%)	cfu/ml	I (%)
Control	95000	0	112000	0	90000	0	95000	0	57000	0	63000	0
1 mg/l	54000	43.2	55000	50.1	50000	44.4	46000	51.7	41000	28.1	31000	50.8
10 mg/l	26000	72.6	31000	72.3	46000	48.9	37000	61.1	21000	63.2	19000	69.8
50 mg/l	12000	87.4	13000	88.4	19300	78.6	11000	88.4	9000	84.2	3000	95.2
100 mg/l	5000	94.7	1300	98.8	5700	93.7	3000	96.8	210	99.6	0	100

Lipovsky et al (2011) found that a concentration-dependent effect of ZnO on the viability of *C.albicans* and at 1 mg/ml. Almost complete killing of 99.5 % of *C.albicans* was observed [17]. Kasemets and coworkers (2011) found that the EC₅₀ value of yeast – *Saccharomyces cerevisiae* was 131 mg/l for nano-ZnO after 24 hours [18]. In the comparison of EC₅₀ values of our studies, we found lower EC₅₀ value of nano-ZnO (59.9 mg/l) than that yeast – *Candida albicans* (59.5 mg/l) after 24 h (Table3).

3.3. Algal (*Chlorella sp.*) Acute Toxicity Studies

The toxicity of NMOs to algal cells is shown Table 5. The NMOs concentrations for all NMOs were in the range of 0.01 to 5 mg/l. Percentages of inhibition were measured after 72 hour incubation period. Algal cells were exposed to NMOs during 72 hours, average growth rate inhibition were calculated by comparison with the control groups and test groups. Table 5 exhibited average growth rate inhibitions of each NMOs calculated after 72 h. Algal cells were affected extremely by NMOs and all NMOs inhibited the algal growth also at low concentrations. At 0.01 ; 0.25 ; 0.5 ; 1 and 5 mg/l nano-HfO₂ concentrations, average growth inhibitions increased from 10.9 % to 16.5 % to 25 % to 62.2 % and to 63.4 %, respectively (Table 5). When the nano-SiO₂ concentrations were up to 5 mg/l from 0.01 mg/l, the average growth rate inhibitions were also up to 94.6 % from 31.7 % after 72 hours exposure time (Table 5). The acute toxicity of Nano-ZnO was high to *Chlorella sp.* in the comparison with nano-HfO₂ and nano-SiO₂ NMOs, the highest average growth rate inhibitions were calculated for nano-ZnO. At 0.01 mg/l nano-HfO₂ concentration, *Chlorella sp.* cells were inhibited 100 % after 72 h (Table 5). ANOVA tests statistics for freshwater algae growth inhibition testst revealed that there is a linear relationship between NMOs concentrations and incubation period (for nano-ZnO, Rsquare=0.970 ; for nano-HfO₂, Rsquare=0.991 ; for nano-SiO₂, Rsquare=0,997). It was found that regression analysis between time (for nano-ZnO, p=0,0002 < 0,05 ; for nano-HfO₂, p=0,0013 < 0,05 ; for nano-SiO₂, p=0,0001 < 0,05) and doses (for nano-ZnO, p=0,0001 < 0,05 ; for nano-HfO₂, p=0,0001 < 0,05 ; for nano-SiO₂, p=0,0001 < 0,05) was significant as a results of ANOVA tests ($\alpha=0,05$).

As seen in Table 3 the EC₅₀ values of all NMOs showed that algal cells are very sensitive to all NMOs even at low concentrations due to low EC₅₀ values. Between three NMOs the most toxic NMO is nano-ZnO because of the lowest EC₅₀ value of 0.55 mg/l (Table 3). Algae is very sensitive to other NMOs. The EC₅₀ values of nano-SiO₂ after 72 h incubation period was 0.89 mg/l/ and the EC₅₀ value of nano-HfO₂ was recorded as 2.94 mg/l after 72 h (Table 3).

Table 5. Average growth rate inhibition of NMOs after 72 hour exposure time

	Nano-SiO ₂	Nano-HfO ₂	Nano-ZnO
	I * (%) – 72 h	I (%) – 72 h	I (%) – 72 h
0.01 mg/l	31.7	10.9	97.8
0.25 mg/l	48.5	16.5	81.1
0.5 mg/l	62.3	25	88.8
1 mg/l	77.8	62.2	96.5
5 mg/l	94.6	63.4	100

[* Average growth rate inhibition (I)]

Algae play an important role in the aquatic ecosystem, not only producing biomass that forms the basic nourishment for food webs, but also contributing to the self-purification of polluted water [20]. But the ecotoxicity studies are very limited for the acute toxicity of NMOs to green algae. The effect of nano-ZnO on algae – *Chlorella vulgaris* were studied by J.Ji et al, (2011). They showed that the EC₃₀ value of nano-ZnO was 20 mg/l after 6 day [20]. Franklin et al. (2007) also observed significant toxicity of nano-ZnO to a freshwater alga *Pseudokirchneriella subcapitata* (IC₅₀ = 0.06 mg/l) with 72 h which is the nearly close to our results [21]. The source of culture media could impact the algal growth and the property and behavior of nanoparticles can affect the toxicological responses of algae [20].

3.4. Biodegradability of NMOs

The biodegradability of NMOs in activated sludge were measured during 28 – days for each 10 and 100 mg/l NMOs. Table 6 showed the soluble-COD concentrations measured for each NMOs, and their removal efficiencies calculated at 5th, 10th, 15th, 20th and 28th days. The easiest biodegradable nanoparticles is nano-SiO₂ due to highest removal efficiency (34.3 %) (Table 6). At low nano-SiO₂ concentrations (10 mg/l) 79% glucose-COD mineralization was detected after 28 days. ANOVA tests statistics for biodegradability tests revealed that there is a linear relationship between NMOs concentrations and incubation period (for nano-ZnO, Rsquare=0.968 ; for nano-HfO₂, Rsquare=0.952 ; for nano-SiO₂, Rsquare=0.935). It was found that regression analysis between time (for nano-ZnO, p=0,0256 < 0,05 ; for nano-HfO₂, p=0,0048 < 0,05 ; for nano-SiO₂, p=0,0497 < 0,05) and days (for nano-ZnO, p=0,0057 < 0,05 ; for nano-HfO₂, p=0,0046 < 0,05 ; for nano-SiO₂, p=0,0006 < 0,05) was significant as a results of ANOVA tests ($\alpha=0,05$). Between three NMOs, the most difficult biodegradable nanoparticle is nano-ZnO. Because there is inhibitory effect of nano-ZnO on the hydrolysis of protein and carbohydrate. This was confirmed in the study performed by Liu et al., (2011). The effect of ZnO on the metabolisms of activated sludge probably depends on the solubilisation of Zn⁺² which was most toxic, followed by nano-ZnO and bulk-sized ZnO [22]. Protein and carbohydrate are the main constituents of activated sludge. These zinc and zinc oxide types are usually in particulate state and cannot be hydrolyzed until solubilization of particulate organic in sludge containing the aerobic bacteria. The particulate organic matters does not biodegraded and they are insensitive to nanoparticles and their dissolved metal ions [22].

Table 6. The biodegradability of NMOs during 28 days

	Nano-SiO ₂		Nano-HfO ₂		Nano-ZnO	
	10 mg/l-COD	100 mg/l-COD	10 mg/l-COD	100 mg/l-COD	10 mg/l-COD	100 mg/l-COD
Günler	Removal Efficiency (%)	Removal Efficiency (%)	Removal Efficiency (%)	Removal Efficiency (%)	Removal Efficiency (%)	Removal Efficiency (%)

t=0	0	0	0	0	0	0
t=5	8.5	10.4	36.1	3.3	3.4	1.4
t=10	15	17.9	38.8	6.6	8.1	3.1
t=15	17.9	18.5	44.02	13.3	9.4	3.9
t=20	20.5	20.5	48.2	18.5	15.7	5.4
t=28	79	34.3	54.4	19.01	16.6	6.4

4. CONCLUSIONS

In conclusion, among three nano-metal oxides (nano-SiO₂, nano-HfO₂ and nano-ZnO) investigated In this study it was found that the most toxic NMO is nano-ZnO to algae – *Chlorella sp.* due to the lowest EC₅₀ value (0.55 mg/l) after 72 hours contacting time and the least toxic NMO is nano-SiO₂ to yeast – *Candida albicans* because of the highest EC₅₀ value (92.7 mg/l) after 24 hours exposure time. While the easiest biodegradable nanoparticles is nano-SiO₂ due to the highest removal efficiencies (34.3 %), the most difficult biodegradable nanoparticles is nano-ZnO because of the least removal efficiencies (6.4 %).

ACKNOWLEDGMENT

This study was prepared in the scope of Master of Sciences in Environmental Earth Sciences, and at the same time it was supported by the Department of Scientific Resource Project (2014.KB.FEN.019), in Dokuz Eylul University Graduate School of Natural and Applied Sciences. Also, the author acknowledged The Scientific and Technological Research council of Turkey (TUBITAK) for financial support (2210-C).

REFERENCES

- [1] A. Kahru, H.C Dubourguier, I. Blinova, A. Ivask, A. and Kasemets, K. Biotests and biosensors for ecotoxicology of metal oxide nanoparticles: A Minireview. *Sensors*, vol. 8-8, pp. 5153–5170, 2008.
- [2] Y. Chen, Y. Su, X. Zheng, H. Chen, H. and Yang H. Alumina nanoparticles-induced effects on wastewater nitrogen and phosphorus removal after short-term and long-term exposure. *Water Research*, vol. 46, pp. 4379-4386, 2012.
- [3] Q. Zhou, X. Wangb, J. Liu and L. Zhang, L. Phosphorus removal from wastewater using nano-particulates of hydrated ferric oxide doped activated carbon fiber prepared by Sol–Gel method. *Chemical Engineering Journal*, vol. 200–202, pp. 619–626, 2012.
- [4] Z. Atlı-Şekeroğlu, Nanoteknolojiden nanogenotoksikolojiye: kobalt-krom nanopartiküllerinin genotoksik etkisi. *Türk Hijyen Derneği Biyoloji Dergisi*, vol. 70-1, pp. 33-42, 2013.
- [5] Z. Rafiq, R. Nazir, D.-Shahwar, M.R. Shah, S. Ali, Utilization of magnesium and zinc oxide nano-adsorbents as potential materials for treatment of copper electroplating industry wastewater, *Journal of Environmental Chemical Engineering*, vol. 2, pp. 642–651, 2014
- [6] A. Garcia, R. Espinosa, L. Delgado, E. Casals, E. Gonzales, V. Puentes, C. Barata, X. Font and A. Sanchez, [Acute toxicity of cerium oxide, titanium oxide and iron oxide nanoparticles using standardized tests](#), *Desalination*, vol. 269/1–3, pp. 136-141, 2011.
- [7] J.A. Field, A. Luna-Velasco, S.A. Boitano, F. Shadman, B.D. Ratner, C. Barnes, R. Sierra-Alvarez, Cytotoxicity and physicochemical properties of hafnium oxide nanoparticles, *Chemosphere*, vol. 84, pp. 1401–1407, 2011.
- [8] T.P. Dasari, K. Pathakoti, and H. Hwang, Determination of the mechanism of photoinduced toxicity of selected metal oxide nanoparticles (ZnO, CuO, Co₃O₄ and TiO₂) to *E. coli* bacteria. *Journal of Environmental Sciences*, vol. 25-5, pp. 882–888, 2013.
- [9] W.F. Owen, D.C. Stuckey, J.B. Healy, L.Y. Young, and Jr. McCarty, Bioassay for monitoring biochemical methane potential and anaerobic toxicity. *Water Research*, vol. 13, pp. 485–492, 1979.
- [10] E. Razo-Flores, M. Luijten, B.A. Donlon, G. Lettinga, and J.A. Field, Complete biodegradation azo dye azodisalicylate under anaerobic conditions. *Environmental Science and Technology*, vol. 31-7, pp. 2098–2103, 1997.
- [11] OECD 201, OECD Guidelines for Testing Chemicals, Freshwater Algae Growth Inhibition Tests. 2006.
- [12] N. Gong, K. Shao, W. Feng, Z. Lin, C. Liang, and Y. Sun, Biototoxicity of nickel oxide nanoparticles and bio-remediation by microalgae *Chlorella vulgaris*. *Chemosphere*, vol. 83, pp. 510–516, 2011.
- [13] OECD 301, OECD Guidelines for Testing of Chemicals, Ready Biodegradability, 1992.
- [14] D. Nguyen, C. Visvanathan, P. Jacob and V. Jegatheesan, Effects of nano cerium (IV) oxide and zinc oxide particles on biogas production. *International Biodeterioration & Biodegradation*, vol. 102, pp. 165–171, 2015
- [15] S.K. Brar, M. Verma, R.D. Tyagi and R.Y. Surampalli, Engineered nanoparticles in wastewater and wastewater sludge: evidence and impacts Waste Manag., vol. 30, pp. 504–520, 2010.
- [16] H. Mu, Y. Chen and N. Xiao, Effects of metal oxide nanoparticles (TiO₂, Al₂O₃, SiO₂ and ZnO) on waste activated sludge anaerobic digestion. *Bioresour. Technol.* vol. 102, pp. 10305–10311, 2011.
- [17] A. Lipovsky, Y. Nitzan, A. Gedanken and R. Lubart, Antifungal activity of ZnO nanoparticles—the role of ROS mediated cell injury. *Nanotechnology*, vol. 22, pp. 105101, 2011.
- [18] Toxicity of nanoparticles of ZnO, CuO and TiO₂ to yeast *Saccharomyces cerevisiae* Kaja Kasemets *, Angela Ivask, Henri-Charles Dubourguier, Anne Kahru *Toxicology in Vitro* 23 (2009) 1116–1122
- [19] C. Garcia-Saucedo, J.A. Field, L. Otero-Gonzalez, R. Sierra-Alvarez, Low toxicity of HfO₂, SiO₂, Al₂O₃ and CeO₂ nanoparticles to the yeast, *Saccharomyces cerevisiae*. *Journal of Hazardous Materials*, vol. 192, pp. 1572– 1579, 2011.

- [20] J. Ji, Z. Longa and D. Lina, Toxicity of oxide nanoparticles to the green algae *Chlorella* sp. *Chemical Engineering Journal*, vol.170, pp. 525–530, 2011.
- [21] N.M. Franklin, N.J. Rogers, S.C. Apte, G.E. Batley, G.E. Gadd and P.S. Casey, Comparative toxicity of nanoparticulate ZnO, bulk ZnO, and ZnCl₂ to a freshwater microalga (*Pseudokirchneriella subcapitata*): the importance of particle solubility, *Environ. Sci. Technol.*, vol.41, pp.8484–8490, 2007.
- [22] G. Liu, D. Wang, J. Wang, C. Mendoza, Effect of ZnO particles on activated sludge: role of particle dissolution. *Sci. Total Environ.* vol.409, pp.2852-2857, 2011.

BIOGRAPHY

Bachelor of Science (B.S.) : Hacettepe University – Biology (2007 - 2012)

Master of Science (M.Sc.) : Dokuz Eylül University – Environmental Earth Sciences (2012 - 2015)

Doctor of Philosophy (PhD) : Dokuz Eylül University – Marine Sciences and Technology (2016 - ...)

Pulp and paper wastewater treatment by using chemical and biological processes: chemical coagulation followed by innovatively designed CSTR

Abdullah Kizilet¹, Merve Yurdaku², Dilda Gumuscu², [Amar Ćemanović](#)³, Ozer Cinar^{2*}

Abstract

The aim of this study is to determine the performance of colour-containing pulp and paper wastewater treatment by using chemical and biological processes that include chemical coagulation followed by innovatively designed CSTR. Determination of optimum pH for coagulation was performed with various pH values (4 to 8) with jar testing. The results for the two selected types of coagulants demonstrate the optimum pH value to be at 5.5. Initially, the most commonly used coagulant Alum ($Al_2(SO_4)_3 \cdot 18H_2O$) was selected. However, Alum failed to produce any effect whatsoever on the coagulation with range of 5 mg /L-2500 mg/L, though optimum conditions were provided. Then, $FeCl_3$ was tried at different dosage and the optimum dosage value was determined of 1500 mg/L under the same conditions. The $FeCl_3$ was superior for the removal of both colour and COD. The colour and COD decreased from average 52330 PtCo and 25675.6 mg/L to 5459,7 and 13622,4 PtCo (89.6% and 47.22% removal efficiency), respectively, with chemical treatment. Despite these results being satisfying in respect to percentage of yield, the results were not sufficient for discharge standards. So, we applied biological treatment with innovatively designed CSTR with an HRT value of 5 days. The biological treatment demonstrated excellent results especially with the removal of colour being on average 96.40% when combined with chemical treatment. on the other hand, the removal COD efficiency increased from 89.6% to 90.70% when combined with chemical treatment.

Keywords: Chemical and biological treatment, CSTR, Pulp and paper wastewater

1. INTRODUCTION

Despite many newspapers and magazines shifting to online publishing, and the emergence of technologies such as e-books, e-government etc., the use of paper is not showing signs of decline. The International Energy Agency (IEA) estimates the annual paper and paperboard demand and production to continue increasing from a value of 365 million tonnes (Mt) in 2006 to between 700 Mt (low estimate) and 900 Mt (high estimate) [1]. This will be mostly noticeable in India, China and some other Asian countries [2]. The pulp and paper industry is specific for its exceptionally high demand for water – between 80 and 180 m³ of wastewater is produced in the process of obtaining 1 ton of pulp, and between 20 and 70 m³ per ton of paper and paperboard manufactured [3]. The exact characteristics of this type of wastewater vary with the type of raw material, treatment type and the employment of effluent recycling [4]. Most common pollutants found, however, include lignin and its derivatives, tannins, sterols, waxes, extractives, diterpene alcohols, fatty acids as well as various chlorinated compounds [5,6,7]. Such effluents can cause great damage to the environment, in the form of slime growth, scum formation, thermal impacts, colour problems etc. Furthermore, the very presence of toxic compounds is lethal to the aquatic life in the receiving bodies, and also affects nearby terrestrial ecosystems [8]. Due to the aforementioned, special efforts have to be applied in order to treat such wastewater so as to meet required standards. Conventional methods have been shown to be insufficient due to the low biodegradability index (BOD₅/COD) of less than 0.4 [9]. Hence, the most common solution is to apply chemical or physico-chemical methods prior to the biological treatment. In the case of pulp and paper wastewater, it may contain substantial amounts of suspended or dissolved solids, so the preferable method would be coagulation [10]. In the coagulation of wastewater, a chemical is added to trigger the solid particles to clump together so they can be easier separated from the rest of the water. Most commonly used chemical coagulants include alum, iron-based salts like ferric chloride, polyacrylamides (PAMs), polyaluminum chloride (PAC), and polydiallyldimethylammonium chloride (polyDADMAC) [11]. Alum generally refers to a group of chemical elements described as hydrated double salts, and consisting mostly of aluminum sulfate, water molecules and the sulfate of some other element. In wastewater treatment, alum usually refers to $Al_2(SO_4)_3 \cdot 18H_2O$ [12]. Ferric chloride ($FeCl_3$) is a crystalline compound which

¹Department of Bioengineering and Sciences, Kahramanmaraş Sutcu Imam University, 46100, Kahramanmaraş, Turkey, abd.kizilet@gmail.com

²Yildiz Technical University, Department of Environmental Engineering, 34220, Esenler/Istanbul, Turkey, ocinar@yildiz.edu.tr

³Istanbul Technical University, Department of Environmental Engineering, Maslak/Istanbul, Turkey.

dissolves well in water to produce a brown, acidic solution. Even though they are proven potent coagulants, the mentioned chemicals also have negative sides, which is why the dosage and applicability needs to be carefully assessed. Those include large volumes of resulting chemical sludge, ineffectiveness in low-temperature water as well as negative effects on human health [13]. Generally COD (Chemical Oxygen Demand), BOD (Biological Oxygen Demand), SS (Suspended Solids), DS (Dissolved Solids), colour, turbidity and heavy Metals etc. using for basic pulp and paper water characterization. Typically pulp and paper industry wastewater include low or high COD (COD from 450 to 34000), pH and turbidity (pH from 2 to 14 [14,15]), turbidity from 15 to 5700 [16]) and also strong colour. The diversity of values arises from material variation.

Continuous Stirred Tank Reactor Colour Removal Performance

Continuous Stirred Tank Reactor (CSTR); CSTR is the easiest probable continuous flow suspended growth bioreactor, which is formed of well mixed tank with rich polluted influent stream and a treated effluent including microorganisms. The wastewater volume in reactor is fixed and the mixing is adequate to make concentrations for all components uniform throughout the reactor and effluent is equal to interior volume concentration [17]. Therefore, these reactors also called as completely mixed reactors. Using SBR to colour removal is fairly new approach compared to anaerobic-aerobic sequential treatment [18]. SBR used for many types of industrial wastewaters such as pulp and paper wastewaters. SBR modified as activated sludge process. Main advantages of this system are low build cost, high flexibility and low required spaces [19]. Significant disadvantages of SBR systems are extreme sludge production and high sludge volume index (SVI) values. CSTR has many advantages that it operates in a steady state, it is well controllable, large heat transfer areas can be installed, although has disadvantage like necessary of high volume,

Chemical Treatment Agents (Coagulation)

Before biological treatment in the innovatively designed CSTR processes, the next unit process in a conventional water treatment system is a mixer, where the first chemicals are added in what is known as coagulation. There are special case occurs in small systems using underground water, when chlorine or other taste and odor control precautions are introduced at the intake and are the extent of treatment. Many researchers have worked the coagulation of synthetic and real pulp and paper wastewater using various inorganic chemicals (e.g., FeCl_3 , FeSO_4 , alum, lime, and MgCl_2) alongside components of biological origin. Auxiliary poly-electrolytes are executed by the forced hydrolysis of a easy coagulant, like alum [20, 21]. The process of coagulation is a series of chemical and mechanical operations by which coagulants are practical and made effective. There are two stages of this process: (1) fast mixing to disperse coagulant chemicals by violent mixing into the water being treated, and (2) flocculation to band together small particles into well-defined floc by attentive mixing for a much longer time. The coagulant must be added to raw water and completely disperse in the liquid; such stability of chemical treatment is achieved by the way of rapid mixing. Coagulation consequences from adding salts of iron or aluminum to the water and is a reaction between one of the following (coagulants) salts and water: Polymers, Sodium aluminate, Ferrous sulfate etc. [22].

Aim of the study

In this study, chemical treatment has been applied prior to biological. The coagulation efficiency and subsequent COD removal has been tested with alum and ferric chloride, separately. Furthermore, by innovatively designed of CSTR mechanism including a settlement cone inside the main reactor has been devised and applied. In this context, the study was to determine the removal of colour natural organic and inorganic matter by enhanced coagulation before biological treatment with CSTR (continuous stirred tank reactor). Despite the fact that obtained satisfactory COD removal, the colour removal results were unsatisfactory after CSTR. So, applied Advanced Treatment (with chemical agents) to effluent of CSTR, in this context; Jar tests were applied by using $\text{Al}_2(\text{SO}_4)_3$, FeCl_3 after enhanced coagulation conditions determined optimum dosage and optimum pH for each coagulant. Although obtained discharge standards by using $\text{Al}_2(\text{SO}_4)_3$, auxiliary polyelectrolytes were used for advance more stronger than wastewater.

2. MATERIAL AND METHODS

2.1. Design and operation of CSTR

Using of CSTR that have total 2.5L to colour removal is fairly new approach. CSTR is the easiest probable continuous flow suspended growth bioreactor, which is formed of well mixed tank with rich polluted influent stream and a treated effluent including microorganisms. The wastewater volume in reactor is fixed and the mixing is adequate to make concentrations for all components uniform throughout the reactor and effluent is equal to interior volume concentration [17]. Therefore, these reactors also called as completely mixed reactors. In this study used CSTR was demonstrated as schematically in the Figure.1. The CSTR was operated with about constant 3000 ± 100 mg/L mixed liquid suspended solids (MLSS).

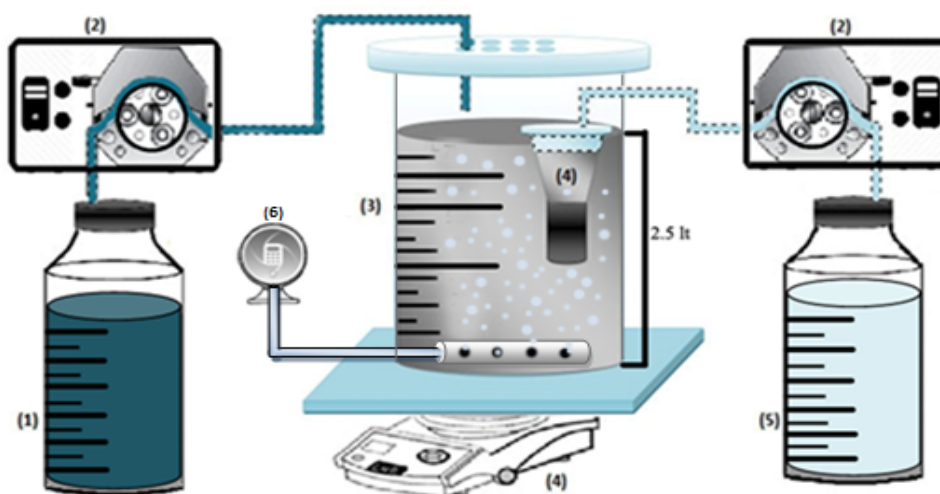

Figure 1. Schematic Representation of CSTR configuration: (1:Influent Tank, 2:Peristaltic pumps, 3:CSTR, 4:Secondary clarifier, 5:Effluent Tank, 6: Air Pump and Diffuser)

Operation conditions

The CSTR was operated under the aerobic conditions. Different hydraulic retention times (HRT) such as; 2, 3, 5 days were examined to obtain optimum colour and COD removal. In this context, CSTR was operated at HRT of 5 days after chemical treatment as optimum HRT. The reactor was fed with real pulp and paper wastewater at $32 (\pm 1) ^\circ\text{C}$ temperature. The reactor has 3 lt volume (2.5 lt active working volume). The influent pH that increased about 8-9 after chemical treatment, was daily adjusted to 7.2 for optimum media of living microorganisms. The CSTR was operated with 5 days hydraulic retention time as continuous flow with peristaltic pump (SHENCHEN V6-3L, China). The study gives wide coverage to effect of different coagulants such as $\text{Al}_2(\text{SO}_4)_3$ (Alum) and FeCl_3 . CSRT was used to treatment pulp and paper wastewater as simulated full-scale treatment plant conditions, and applied after advanced chemical treatment.

2.2. Wastewater Characteristic

The real pulp and paper wastewater was obtained from full-scale treatment plant. The used real pulp and paper wastewater wide range influent colour (50002-54775 PtCo). Daily pH of the influent fed was adjusted for optimum chemical treatment to 7.2 (raw pH 9.2). The used real pulp and paper wastewater main characteristics average were tabulated in the Table.1.

Table 1. The used real pulp and paper wastewater main characteristics

Parameter	Unit	Raw Wastewater
Average COD	mg/L COD	≈25675,6
PtCo	-	≈52330
Contuctivity	mS/cm	7.2
436nm(abs)	CN (λ)	140.31
525nm(abs)	CN (λ)	84.16
620nm(abs)	CN (λ)	75.71
Turbidity	NTU	250
Suspended solids	mg/L	550±50
pH	-	10.4

The colour unit of absorbance about the wave length was converted to Chrominance Number (CN) unit by using equation 1. Also daily wave length scanning was examined for influent water, the result of this scanning was 558 nm as shown also in the Table.1.

$$CN(\lambda) = \frac{A}{d} * f \quad (1)$$

Here;

CN (λ): λ wave length, number of chrominance value (m^{-1})

A= λ The absorbance value of the sample wave height (absorbance read) (cm^{-1})

d: Cell thickness (mm),

f: factor to obtain the spectral absorbance values of m^{-1} of unit, $f=1000$,

2.3. Analytical Methods

Chemical Treatment

Coagulation process is commonly applied as a pre-treatment or primary treatment to remove suspended solids from industrial effluent including pulp and paper mill effluent. However, the excessive use of inorganic coagulants, such as $Al_2(SO_4)_3$ and $FeCl_3$ poses deleterious environmental impacts and risks to living organisms include low biodegradability, increase of metal content in discharged effluent and generation of toxic sludge. In view of this, the present study investigated the potential of biological treatment in the CSTR, after chemical treatment to decrease cost and the other side effect of chemical treatment.

Jar tests were applied by using $Al_2(SO_4)_3$, $FeCl_3$ after enhanced coagulation conditions determined optimum dosage and optimum pH for each coagulant. Firstly tried determine optimum pH (2, 2.5, 4, 5,5.5, 7.5, 9) and optimum dosage mg/L; (100,200, 250,300,500,750,1000,1500,2000,2500) for both $Al_2(SO_4)_3$ and $FeCl_3$. Then, tried determine optimum stirring speeds, waiting periods for settlement before biological treatment. The best chosen results were shown in the Result and Discussion section.

COD measurement

The COD measurement method determines the quantity of oxygen required to oxidize the organic matter in a waste sample, under specific conditions of oxidizing agent, temperature, and time. Since the test utilizes a specific chemical oxidation the result has no definite relationship to the Biochemical Oxygen Demand (BOD) of the waste or to the Total Organic Carbon (TOC) level. In this study, titrimetric method (Standard Method 5520) was used. The test result should be considered as an independent measurement of organic matter in the sample, rather than as a substitute for the TOC test. Organic and oxidizable inorganic substances in the sample are oxidized by potassium dichromate in 50% sulfuric acid solution at reflux temperature. Silver sulfate is used as a catalyst and mercuric sulfate is added to remove chloride interference. The excess dichromate is titrated with standard ferrous ammonium sulfate, using orthophenanthroline ferrous complex as an indicator. Samples are boiled with a strong oxidizing $K_2Cr_2O_7$ severe acid conditions in the thermoreactor (WTW-CR 3200, Wissenschaftlich-Technische Werkstätten, Weilheim, Germany). Two hours of boiling a standard amount of remaining oxidizing eventually consumed without allowing oxidation of reduced (ferrous ammonium sulphate) was assessed on the basis of substance solution with the volumetric determination of the road (APHA, 2005) [23].

Turbidity, pH, conductivity measurement

The turbidity analyses were measured by turbidimeter (WTW-Turb 550 IR, Wissenschaftlich-Technische Werkstätten, Weilheim, Germany) with NTU of unit. The measurement of free electrons released as a result of the biochemical reactions that occur in the CSTR. The conductivity is indicative of the free electrons. The pH of a solution indicates how acidic or basic it is in the reactor. The pH and conductivity of samples were measured using multimeter (HACH-HQ 40d Portable Multi-meter, Loveland, U.S.A). Standard methods used for the other series of analysis.

3. RESULTS AND DISCUSSION

3.1 COD Removal with Chemical and Biological Treatment

The fig.2 presents the values obtained from raw influent wastewater, wastewater after chemical and after biological treatment in terms of COD reduction and colour removal (on the PtCo scale). The reduction in average values of COD was almost 50% after chemical treatment, and 96,40% after biological treatment. The results for colour removal were around 90% (on average) both after the chemical and the biological treatment. The COD removal results were demonstrated with chemical and biological treatment, subsequently.

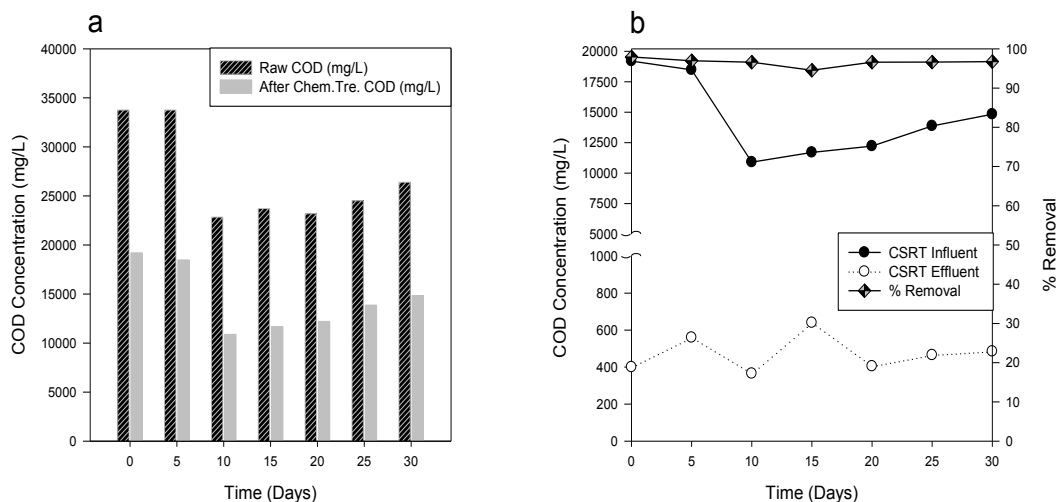

Figure 2. COD Removal; (a) with Chemical Treatment (b) with Biological Treatment

In the previous studies, Smólka et al., demonstrated COD removal in the similar wastewater treatment with continuous system [24]. Their system was efficient in the COD reduction (> 88 %), the level forced by legislation for influents to surface water was exceeded. Furthermore, the outflow pH was around 9 irrespectively of the feed pH (about 7) similar to our study. Also, they showed that the effluent conductivity reached to 16 mS/ cm higher than our results.

3.2. Determination of Optimum pH Values for Al₂(SO₄)₃ and Fe₃Cl

To Determine optimum pH value of both Al₂(SO₄)₃ and FeCl₃, different dosages were tried range of dosage mg/L; (100,200, 250,300,500,750,1000,1500,2000,2500) for both Al₂(SO₄)₃ and FeCl₃. Treatment with alum produced insufficient effect on the pulp and paper wastewater. The optimum dosage of 1500 mg/L FeCl₃. To determine optimum pH values, jar tests were applied by using Al₂(SO₄)₃ and FeCl₃ after enhanced coagulation conditions determined optimum dosage and optimum pH for each coagulant. Firstly tried to determine optimum pH (2, 2.5, 4, 5,5,7,5, 9) for both Al₂(SO₄)₃ and FeCl₃. As a results of these tries the optimum pH values were obtained the optimum pH value of 5.5 for FeCl₃ based on both PtCo and COD removal. Adjusted influent pH increased average from 5.5 to 8, also conductivity average from 6.9 to 7.99 after chemical treatment and then did not increase significantly after biological treatment.

3.3 Turbidity (NTU) Removal with Chemical Treatment Before Biological Treatment

Treatment with alum produced insufficient effect on the pulp and paper wastewater. The highest reduction of the values of turbidity (measured in NTU units), colour and COD reached levels of 20-30%, either with alum alone or together with polyelectrolyte (PE) added. The highest COD removal was measured at 20,18% with 2500 ppm alum+PE added. In comparison, ferric chloride performed much better in nearly all tested scenarios. Hereby, the maximum achieved NTU reduction was 52,69% as shown in the table 2; the maximum colour reduction (PtCo) was 48,8%; and the maximum COD reduction was 46,3% (in combination with PE). The NTU results at different dosage of Alum and Fe₃Cl tabulated in the Table 2.

Table 2. NTU results at different dosage of Alum and Fe₃Cl

Alum Dosage	NTU (Inf.)	NTU (Alum)	% Removal	NTU (Alum+PE)	% Removal	Fe ₃ Cl Dosage	NTU (Giriš)	NTU (Fe ₃ Cl)	% Removal	NTU (Fe ₃ Cl+PE)	% Removal
100 ppm	499	450	9,8	440	11,8	100 ppm	499	688	0	630	0
200 ppm	499	463	7,2	420	15,8	200 ppm	499	695	0	690	0
250 ppm	499	499	0,0	450	9,8	250 ppm	499	615	0	610	0
300 ppm	499	470	5,8	490	1,8	300 ppm	499	588	0	650	0
500 ppm	499	450	9,8	617	0,0	500 ppm	499	618	0	1000	0
750 ppm	499	532	0,0	926	0,0	750 ppm	391	353	9,7	242	38,1
1000 ppm	499	499	0,0	547	0,0	1000 ppm	391	395	0,0	256	34,5
1500 ppm	499	489	0,0	591	0,0	1500 ppm	391	492	0,0	185	52,7
2000 ppm	499	488	0,0	698	0,0	2000 ppm	391	503	0,0	537	0
2500 ppm	499	487	0,0	694	0,0	2500 ppm	391	720	0,0	741	0

It can be deduced that ferric chloride has a much higher efficiency when applied to this type of wastewater, and that polyelectrolyte generally improves results, be it in combination with alum or with ferric chloride. Accordingly, ferric chloride was used for further analysis.

3.4 Colour Removal with Chemical and Biological Treatment

The colour and COD decreased from average 52330 PtCo and 25675.6 mg/L to 5459.7 and 13622.4 PtCo (89.6% and 47.22% removal efficiency), respectively, with chemical treatment. Despite these results being satisfying in respect to percentage of yield, the results were not sufficient for discharge standards. So, we applied biological treatment with innovatively designed CSTR with an HRT value of 5 days. The biological treatment demonstrated excellent results especially with the removal of colour being on average 96.40% when combined with chemical treatment. On the other hand, the removal COD efficiency, as relevant to colour removal, increased from 89.6% to 90.70% when combined with chemical treatment. The colour results were demonstrated in the fig.3.

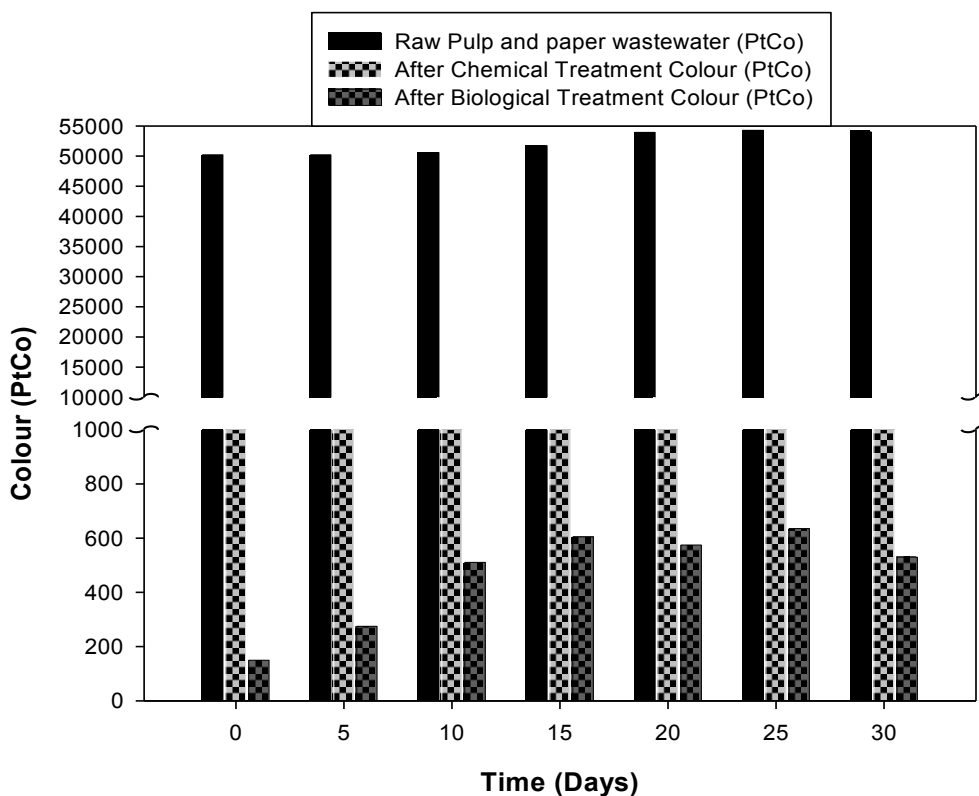

Figure 3. The Colour Removal with Chemical and Biological Treatment

In addition to all these, the wavelength scanning data for colour removal tested with the wavelength of 606 nm. The average removal was 87%, with the highest value reaching 97,8%. The obtained values prove that the combined chemical and biological system tested is very efficient in treating wastewater from the pulp and paper industry.

4. CONCLUSIONS

In this study, very high paper wastewater containing COD and colour were measured. In view of this, the present study investigated the potential of biological treatment in the CSTR, after chemical treatment to decrease cost and the other side effect of chemical treatment. Firstly we tried Alum for chemical treatment. However, Alum failed to produce any effect whatsoever on the coagulation though optimum conditions were provided. Then, $FeCl_3$ was tried at different dosage and the optimum dosage under the same conditions. The $FeCl_3$ was superior for the removal of both colour and COD. The colour and COD decreased from average 52330 PtCo and 25675.6 mg/L to 5459,7 and 13622,4 PtCo (89.6% and 47.22% removal efficiency), respectively, with chemical treatment. Despite these results being satisfying in respect to percentage of yield, the results were not sufficient for discharge standards. So, we applied biological treatment with innovatively designed CSTR with an HRT value of 5 days. The biological treatment demonstrated excellent results especially with the removal of colour being on average 96.40% when combined with chemical treatment. on the other hand, the removal COD efficiency increased from 89.6% to 90.70% when combined with chemical treatment.

REFERENCES

- [1] International Energy Agency (IEA), "Energy Technology Transitions for Industry – Strategies for the Next Industrial Revolution," Paris, France, 2009.
- [2] L. Kong, A. Hasanbeigi, L. Price, "Assessment of emerging energy-efficiency technologies for the pulp and paper industry: a technical review," *Journal of Cleaner Production*, 122, 5-28, 2016.
- [3] J.A. Rintala, J.A. Puhakka, "Anaerobic treatment in pulp and paper mill waste management: a review," *Bioresour. Technol.* 47, 1-18, 1994.
- [4] R. Sridhar, V. Sivakumar, V. Prince Immanuel, J. Prakash Maran, "Treatment of pulp and paper industry bleaching effluent by electrocoagulant process," *J. Hazard. Mater.* 186, 1495-1502, 2011.
- [5] S.S.Wong, G.D. Najafpour, T.T. Teng, et al., "Treatment of pulp and paper mill wastewater with cationic and anionic polyelectrolytes," *Iran. J. Energ. Environ.* 1, 106-115, 2010.

- [6] I. Oller, S. Malato, J.A. Sánchez-Pérez, "Combination of advanced oxidation processes and biological treatment for wastewater decontamination—a review," *Sci. Total Environ.* 409, 4141–4166, 2011.
- [7] A. Dhir, N.T. Prakash, D. Sud, "Coupling of solar-assisted advanced oxidative and biological treatment for degradation of agro-residue-based soda bleaching effluent," *Environ. Sci. Pollut. Res.* 19, 3906–3913, 2012.
- [8] E. El Bestawy, I. El-Sokkary, H. Hussein, A.F. Abu Keela, "Pollution control in pulp and paper industrial effluents using integrated chemical-biological treatment sequences," *J Ind Microbiol Biotechnol* 35, 1517-1529, 2008.
- [9] M. Al-Shannaq, W. Lafi, K. Bani-Melhem et al., "Reduction of COD and TSS from Paper Industries Wastewater using Electro-Coagulation and Chemical Coagulation," *Separation Science and Technology* 47, 700–708, 2012.
- [10] M. Basibuyuk, S. Unlu, D.G. Kalat, "Use of waterworks sludge, Ferric Chloride and Alum for the Treatment of Papermill Wastewater," *Asian Journal of Chemistry* 16, No.1, 103-112, 2004.
- [11] W. Subramonian, T.Y. Wu and S.-P. Chai, "A comprehensive study on coagulant performance and floc characterization of natural *Cassia obtusifolia* seed gum in treatment of raw pulp and paper mill effluent," *Industrial Crops and Products* 61, 317–324, 2014.
- [12] Alum, *Encyclopædia Britannica. Encyclopædia Britannica Ultimate Reference Suite*. Chicago: Encyclopædia Britannica, 2013.
- [13] C.-Y. Yin, "Emerging usage of plant-based coagulants for water and wastewater treatment," *Process Biochem.* 45, 1437–1444, 2010.
- [14] W.J Lau, and A.F. Ismail. "Polymeric nanofiltration membranes for textile dye wastewater treatment: preparation, performance evaluation, transport modelling, and fouling control- a review" *Desalination* 245, 321-348, 2009.
- [15] D.J Joo, W.S Shin, J.H.; Choi, S.J.; Choi, M.C Kim, M.H. Han, T.W Ha, and Y.H.Kim, "Decolour ization of reactive dyes using inorganic coagulants and synthetic polymer", *Dyes and Pigments*, 73, 59-64, 2007.
- [16] Ciabatti, I., Tognotti, F., Lombardi, L., 2010. Treatment and reuse of dyeing effluents by potassium ferrate. *Desalination* 250, 222e228.
- [17] C. P. Leslie Grady, Jr., and Henry C. Lim "Biological Wastewater Treatment: Theory and Applications" 2nd ed. English, Book, Marcel Dekker, 1999.
- [18] I. K. Kapdan and R. Ozturk, "Effect of operating parameters on colour and COD removal performance of SBR: Sludge age and initial dye stuff concentration", *J. Hazardous Materials*, 123, 217-222, 2005.
- [19] R. Ganjesh, G. Balaji, and R. A. Ramanujam, R. A., "Biodegradation of tannery wastewater using sequencing batch reactor Respirometric assessment", *J. Bioresource Tech.*, 97, 1815–1821, 2006.
- [20] B. H.; Tan, T. T.; Teng, A. K. M Omar, "Removal of dyes and industrial dye wastes by magnesium chloride", *Water Res*, 34, 597-601, 2000.
- [21] P, Moussas and A. Zouboulis, "A new inorganic–organic composite coagulant, consisting of Polyferric Sulphate (PFS) and Polyacrylamide (PAA)", *Water Res.*, 43, 3511–3524, 2009.
- [22] F. R. Spellman, "Mathematics manual for water and wastewater treatment plant operators", 2nd ed., English, Book, Taylor & Francis Group, 2014.
- [23] APHA, American Public Health Association (1995). *Standart Methods for the Examination of Water and Waste Water*, 19th ed., APHA-AWWA-WEF, Washington, DC. USA.
- [24] A. K. Smólka, J. S. Ledakowicz, K. Pazdzior and S. Ledakowicz, "Application of anoxic fixed film and aerobic CSTR bioreactor in treatment of nanofiltration concentrate of real textile wastewater", *Chemical Papers*, 64 (2), 230–236, 2010.

Comparison of Performance of Conventional Membrane Bioreactor with Dynamic Membrane Bioreactor

Mehmet Akif Veral¹, Abdullah Kizilet², Ozer Cinar^{1*}

Abstract

The purpose of this study is about comparison of non-woven and 0.45 μm pore size real membrane placed in one aerobic tank and under same conditions. Comparison has been made between dynamic membrane bioreactors (DMBR) and membrane bioreactor (MBR), which have been employed in a widespread manner, to develop a convenient solution of high membrane cost handicap. Both membrane types operated under same aerobic conditions such as; volume, LMH and SADM. In addition, they have been fed with synthetic municipal wastewater and operated periodically to hinder membrane fouling. At the end of approximate one month adaptation time course, bioreactors, which have reached stable conditions, have been operated to gather the data throughout 60 days. COD removal rates and turbidity results have been compared and non-woven dynamic membrane results have shown similar results to real membrane in terms of efficiency. Furthermore, dynamic membrane has exposed air back wash and pressure changes examined. While average COD removal is determined 93% for non-woven dynamic membrane and 95% for 0.45 μm pore size real membrane, turbidity values have obtained 1,5 NTU and 0,7 NTU for non-woven and 0.45 μm real membrane, respectively.

Keywords: Dynamic membrane, membrane bioreactors, non-woven and 0.45 μm membrane

1. INTRODUCTION

There has been growing relevance for biological wastewater treatment methods using membranes. Solid-liquid separation processes are being done in the way of biological wastewater treatment and in particular, membrane bioreactors (MBRs) are playing essential role in treatment processes [1]. With the benefits and usage of micro/ultrafiltration, MBR ensures significant benefits and progression if it is compared with conventional active sludge processes (CASP), while pore size of the membrane doesn't allow to pass all substances or colloidal particles through the pores whose range is between 0.05-0.4 μm [2]. MBRs are combination of permeable membranes and they include the physical separation of refined water and biomass. In conventional active sludge process, biochemical oxidation and water/biomass separation occurs in two different tank but MBRs make it convenient to proceed in one tank [1, 3]. Therefore, membrane bioreactors hinder the production of sludge whose amount normally increases throughout the process and employ high concentration of constituents of mixed liquor that comprises colloidal particles or solid substances suspended in the reactor. It also provides high dispelling yield of biological oxygen demand (BOD) and chemical oxygen demand (COD) [3]. While process has been done by using aerobic and anaerobic bacteria cultures, different types of membranes are being tested for better performance. Combination of the reactors and more convenient module designs ensures visually induced footprint. Throughout the separation process, usage of the membrane that filtrates the mixed liquor enhances the quality of excreted effluent. Therefore, MBR systems permit engagement of the bacteria in each other and forming flocs through the surface of the membrane and it also blocks the transition of colloidal particles from the pores and sustains sterilization [4, 5]. However, there are wide spread applications of aerobic MBR studies in the literature, there are also anaerobic processes in the applications of MBR system [6, 7]. Although, effluent quality and low system footprint are mentioned as benefits of MBRs, it has some primary limitations like; low flux, energy demand, membrane cost and clogging control. All those problems can be solved by using dynamic membrane technology (DMBR) [1, 8, 9]. Generally membrane pores are plugged because of organic materials or colloidal particles. DM layer hinders the blockage of support material by biomass filtration layer that underlies on DM itself [10, 11, 12]. Throughout the process, transition/movement of the suspended solid particles creates a cake layer on the membrane. Generation of the cake layer can decide the refusal characteristics of the process because cake layer itself plays the secondary membrane role hence after [13, 14, 15]. Water backwash, air backwash or scrubbing methods can be efficient to clean the dynamic membranes without using chemical substances [16]. Nevertheless, cleaning without using chemical substances may employ transient deprivation of effluent. One of the most critical properties for the dynamic membranes is the preclusion of the solid substances through the surface of the secondary membrane which can be comprised or regenerated by itself called

¹Yildiz Technical University, Department of Environmental Engineering, 34220, Esenler/Istanbul, Turkey.
veralakif@gmail.com

²Department of Bioengineering and Sciences, Kahramanmaraş Sutcu Imam University, 46040, Kahramanmaraş, Turkey.
abd.kizilet@gmail.com

^{*}Yildiz Technical University, Department of Environmental Engineering, 34220, Esenler/Istanbul, Turkey.
ocinar@yildiz.edu.tr

self-forming dynamic membrane (SFDM). However, formation and/or reformation of the dynamic membrane layer may diminish the transmissivity of the membrane which is similar hitch that has been seen in conventional MBRs [17]. Micro/ultrafiltration membranes are overpriced than other low cost materials like mesh, non-woven fabric and woven wire cloth which can be used as support material for the generation of dynamic layer [9, 18, 19, 20]. In addition, employing low cost materials, which are mentioned above, instead of using traditional materials ensures high rate flow of liquid at lower transmembrane pressure (TMP) in cost saving field [3, 15, 21, 22].

In this study, two different types of membranes, non-woven and 0.45 μm pore size real membrane, have been employed and compared in each other in terms of Turbidity, TMP, SMP, EPS and CST analyses.

2. MATERIAL AND METHOD

Two different membrane modules were performed and one lab scale aerobic membrane bioreactor (AeMBR) tank was designed. It was made of plexiglas at dimensions of 8x14x38 cm operated in total volume of around 3000 ml and active volume of 2500 ml. Suspended solids concentration was stabilized at 5000 mg AKM/L. Reactor was equipped with water level sensor and aeration device, which procures mixing and continuous physical membrane cleaning, at the bottom. Inside of the tank, two different membrane types, non-woven flat-sheet polyethersulfone (PES) microfiltration and 0.45 μm pore size real membrane, were employed for the operation and double-sided support layer was utilized for the membrane stableness. Each membrane module, made of 12x12 cm plexiglas, had volume of 217 ml and active surface area was adjusted to 7.5x7.5 cm^2 (Fig.1).

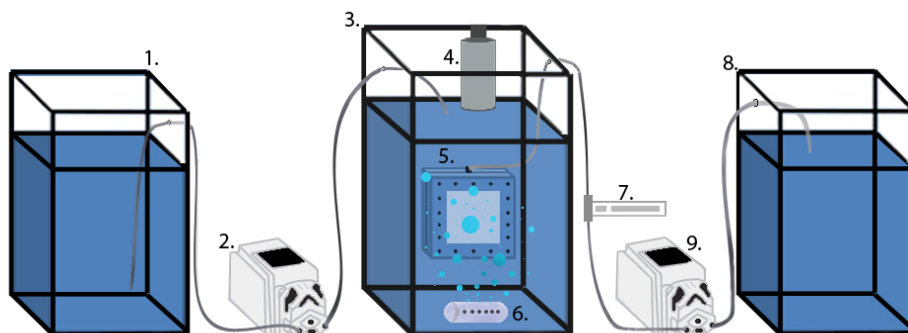

Figure 1. Schematic representation of MBR system: 1. Feed Tank, 2. Feed Pump, 3. Reactor, 4. Level Sensor, 5. Membrane Modules, 6. Air Diffuser, 7. Air Flow Regulator, 8. Permeate Tank, 9. Suction Pump

MBR system was operated at 11.11 LMH flux and 10 LMH net flux. SADm value and membrane suction pumps' flow rate was 1 Nm^3 (air)/ m^2 .hour and 2.08 ml/minute, respectively. Membranes were operated 4.5 min. and kept 0.5 min rest. When the membrane pressure reached 250 mbar pressure, dynamic membrane module was subjected to physical cleaning process. Every day, air backwash operation implemented to the membranes to reduce plugging at 22.5 L (air)/hr. flux through 1 minute. It was noticed that physical cleaning and air backwash pressure values were at desired level, in terms of transmembrane pressure (TMP).

Synthetic Wastewater Characteristics and Operation Procedures

The feed water of the MBR system was synthetic wastewater and feed chamber was filled regularly as 7000 ml every day. Chemicals of synthetic wastewater were represented at Table 1 and sucked permeate accumulated into two different tanks. Established AeMBR was operated interminably, because throughout its operation no kind of sludge elimination process was employed. However, pumps were adjusted 4.5 minutes of suction pressure so as to apply 30 seconds rest. This is one of the methodologies widely used to prevent plugging. To prevent clogging, non-woven dynamic membrane was administered for backwash operation each day, one minute and 0.45 μm pore size membrane was not employed for the same operation.

Table 1. Synthetic Wastewater Content

Chemicals	Concentration (mg/L)
C ₆ H ₁₂ O ₆ .H ₂ O	500
NaHCO ₃	2754
NH ₄ Cl	230
K ₂ HPO ₄	37
KH ₂ PO ₄	67
MnSO ₄ .H ₂ O	0.4289
ZnSO ₄ .7H ₂ O	0.1053
NaSO ₃	0.2811
CuSO ₄ .5H ₂ O	0.0556
FeSO ₄ .7H ₂ O	5.92
NiSO ₄ .6H ₂ O	0.1
CoCl ₂ .6H ₂ O	1

Net Flux Calculations

Amount of water passing along the unit surface area of membrane per unit of time is simply called flux, J. In this context, flux can be formulated as [3];

$$Flux = \frac{Flow}{Area} \quad J = \frac{Q}{A} = \frac{Volume}{Time \times Area} \quad (1)$$

MBR system was operated in 5 minutes periods as 4.5 min. working and 0.5 min. rest. Net flux is represented with the following formula [3];

$$Net\ flux = flux \times \frac{running\ time}{waiting\ time + running\ time} = 11.11 \times \frac{4.5\ min.}{(0.5 + 4.5)\ min.} \cong 10\ LMH \quad (2)$$

2.1. Surface area, Flow and SADm Calculations

Dimensions of the membrane were 7.5cmx7.5cm. Active surface area calculation is presented with an equation below;

$$Active\ surface\ area = 7.5\ cm \times 7.5\ cm \times 2(\text{membrane modules}) = 0.01125\ m^2$$

Flow, can be calculated by multiplying the flux and membrane surface area. Active surface area and flux are calculated as 0.01125 m² and 11.11 LMH (L/m².saat), respectively. Flow is calculated by the following equation [3];

$$Flow = 11.11 \frac{L}{m^2 \cdot hour} \times 0.01125\ m^2 = 0.125\ L/hour \quad (3)$$

Volume of permeate which should be evacuated from the operation and volume of flow that should be sucked by the pumps were computed via following balance, respectively;

$$Permeate = 0.125 * 24 = 3000\ L$$

$$Flow = \frac{Volume}{Time} = \frac{3000\ L}{1440\ min.} = 2.083 \cong 2.08\ ml/minute$$

System was operated under 1 Nm³·hr/m² SADm value and required oxygen amount is calculated as;

$$SADm = \frac{Q(\text{air})}{Area} \quad SADm = \frac{Nm^3/hr}{m^2} \quad 1 = \frac{Nm^3(\text{air})}{0.1125 \times 1hr} \quad (4)$$

Amount of air for a membrane module calculated as 11.25 L/hour. In our system, two membrane modules were operated, so total amount of air for the reactor was calculated as 22.5 L/hour.

2.2. Analytic Methods

2.2.1. Chemical Oxygen Demand

While samples taken from feed tank were two times diluted for analysis, samples taken from permeate tank were not diluted and directly utilized in the NTU experiment. There were four experimental tubes reserved for the COD process. 2 individual, 2.5 ml, samples were taken from real and dynamic membranes permeate and 2.5 ml distilled water was taken as witness sample. On the other hand, 1.25 ml sample from the feed tank was mixed with 1.25 ml distilled water for two times dilution. These four different types of samples were stored individually to the tubes and 1.5 ml potassium dichromate and 3.5 ml silver sulfuric acid (Ag_2SO_4) were added inside of the tubes. After then, tubes were stored inside of the thermoreactor, for 120 minutes at 150°C . WTW CR 3200 brand thermoreactor was used and after two hours, tubes were taken from thermoreactor and allowed to cool down. Titration process was ensured by using magnet inside beaker placed on mixer. While beaker was stirring the mixture, two drops of ferroin indicator were added and titrated with the FAS solution. At the end, consumptions were noted.

2.2.2. Determination of Turbidity, Transmembrane Pressure, CST

Suspended solids inside of the water and soluble inorganic constituents can cause and also increase the turbidity parameters. Unit of the turbidity is NTU in nephelometric turbidimeters. In experimental phase, WTW TURB 550IR type turbidimeter instrument was employed. Therefore, determination of the turbidity was done by two individual 35 ml samples taken to the 50 ml falcon tubes from the permeate of 0.45 pore size real membrane and non-woven dynamic membrane. Before turbidimeter was run, 1000 NTU, 10 NTU and 0.02 NTU standard solutions glass tubes were cleaned up painstakingly with glass-cloth and put to dedicated wells of the instrument respectively for calibration process. Turbidimeter glass tube was washed with the soap and rinsed. Then, washed with distilled water, wiped with glass-cloth, shaken two times with few drops of sample of interest for the measurement and 25 ml sample was put inside of the tube which was shaken at that moment. Tube was placed inside of the instrument and measurement results were noted for both sample types. Transmembrane Pressure (TMP) Measurement: Throughout the experiment, pressure measurements were done daily with TMP instrument. As a result of dynamic membrane pressure reach of 250 mbar it was sentenced to backwash. Increase in pressure indicates that membrane blockage occurred. All pressure measurements were carried out programmable digital manometer (KELLER-Leon record, Swiss), and Installerlogger5 the software. Air Backwash: Backwashing the membrane with water and the negative or positive pressure to be lifted to rest on was one method for preventing the blockage problem. Membranes operated at high flux can run in a shorter time period and blockage can be prevented by more frequent backwashing or rest periods applying (D.C. Stuckey, 2012). In this experiment, backwash was employed only for non-woven dynamic membrane, daily. Backwashing was done for 1 minute, while flux was kept constant. Capillary Suction Time (CST), SMP, EPS Analyses: Capillary suction time (CST) is a widely utilized methodology to measure the filterability and related with the movement of water from the sludge through 1 cm path in a particular time period, in a porous capillary membrane. In experiment, the determination of sludge filtration properties and to determine the relationship of capillary absorption time with obstruction, CST instrument (Triton 304M, England) was used to determine CST. SMP was determined after centrifugation of the samples at 4000 rpm for 10 min. from the reactor effluent obtained at experimental stages of filtering supernatant samples and amount of protein and carbohydrates obtained from filtrate. Samples taken from reactor were centrifuged for the EPS analyze and EPS in biomass was extracted. EPS extraction process was carried out just as specified in the book of Judd (2006) with the heating. EPS value was stated as protein and carbohydrate concentration. Analyses were made by Bradford (1976) and Dubois (1956) methods, respectively.

3. RESULTS AND DISCUSSION

3.1 COD Experimental Results

Through the operation of MBR system, COD experiment results are represented at Fig. 2 by the samples taken from influent synthetic feed wastewater, non-woven dynamic membrane and 0.45 μm pore size real membrane permeate. COD tests were made every three days for 60 days. During the experiment, it was noticed that COD concentrations of non-woven dynamic membrane was lower than 0.45 μm pore size real membrane. COD concentration of dynamic membrane was time to time higher than the real membrane because it takes time to ensure the stability of the dynamic membrane and backwashing operations from time to time when membrane stableness was disrupted.

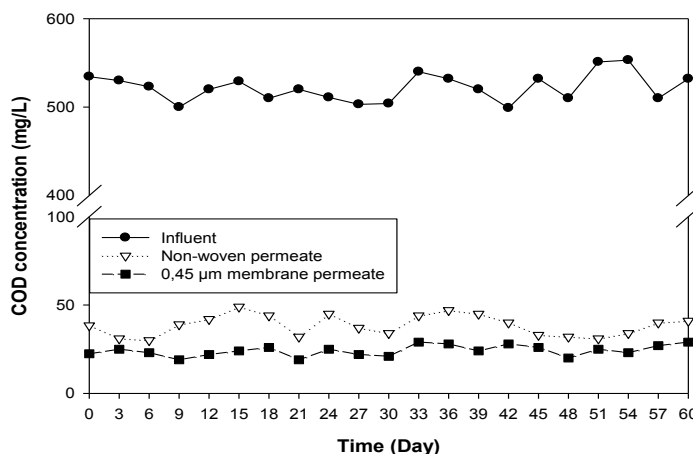

Figure 2: COD concentrations of influent, real and dynamic membrane Throughout MBR operation.

Until reactor reaches decisive condition, COD concentrations are high. In this context, COD data taken from the samples were imprinted when the reactor come up with stable standards. There has been reduction of COD concentrations of non-woven dynamic membrane after day 42. It was thought that this reduction occurred due to inefficient removal yield of cake layer that formed on the surface of membrane by plugging.

COD concentrations of non-woven dynamic membrane were quite close to the real membrane when the cake layer on membrane surface became stable. Throughout the operation duration, total COD concentration of influent wastewater was maximum 551 mg/L and COD concentrations from permeate were 19 mg/L and 30 mg/L for real and dynamic membrane, respectively. COD values from influent wastewater may change due to the environmental circumstances which can be affected. Through 60 days, COD removal performance results of 0.45 μm pore size real membrane and non-woven dynamic membrane were given at Fig.3. Along the operation, it was noticed that COD removal yield of non-woven dynamic membrane was lower than 0.45 μm pore size real membrane. It was because of non-woven dynamic membrane permeate contains high COD causing bacteria concentration. COD analyses were not exposed any kind of filtration operations and directly performed with titrimetric method in terms of representing real values.

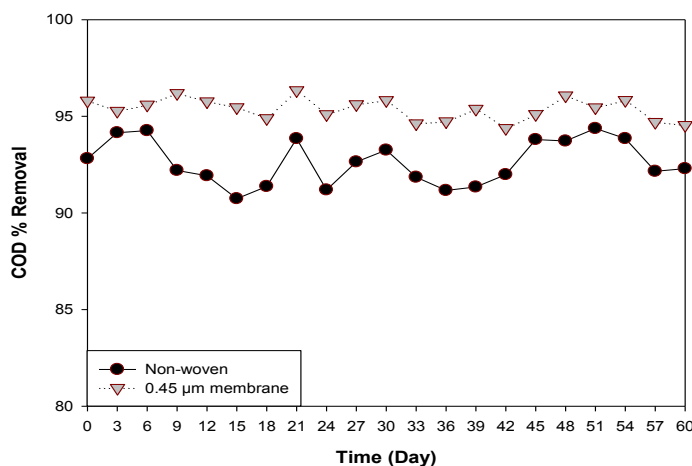

Figure 3: COD removal yields of real and dynamic membrane through the MBR operation.

Close COD concentration percentages between non-woven and dynamic membrane from permeate was already noticed in research made by Lee et al. [23]. However, some studies employment of non-woven fabric filter and micro-filter membranes showed convenient performance for mixed liquor separation [24].

3.2 Turbidity Result

Turbidity results of the samples taken from non-woven dynamic membrane and 0.45 μm pore size real membrane are represented at Fig. 4. Samples were taken every three days and determination of turbidity was made through two mounts for every three days.

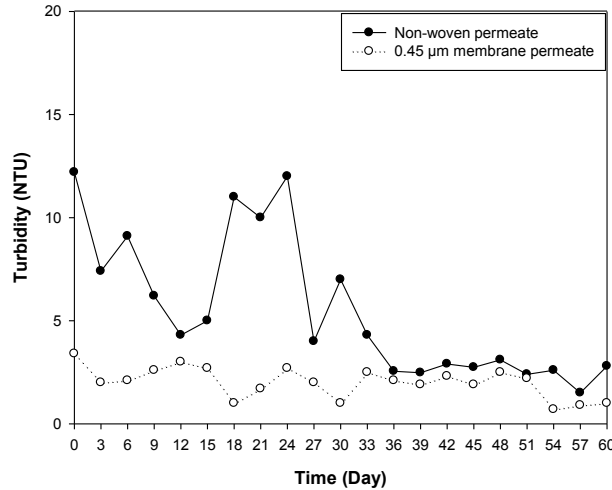

Figure 4: Turbidity results of dynamic and real membrane through MBR operation.

In the filtration of the standard turbidity solution, turbidity removal of the dynamic membrane showed [3, 25]. There have been changes at the removal performance of the membranes in MBR. The reason of high turbidity results of dynamic membrane is because of the membrane stability which was ensured at first 24 days. 0.45 μm pore size real membrane came up with much better turbidity results. Last 30 days of the experiment, turbidity values of dynamic membrane was quite close to the real membrane due to the plugging and increase at the removal yield.

3.2 TMP Measurements

In the experiment, distilled water transition was ensured over the membrane surface for both membrane types and pressure measurements were recorded. Even though the pressure values were obtained when distilled water released for 24-hour measurements, operation was repeated for better performance and comparison. Pressure measurements of real membrane were made and noted every three days. Fig. 5 represents the pressure measurement of the real membrane. After then, the system has been started to run and synthetic wastewater feeding.

In MBR system, synthetic wastewater from 0.45 μm pore size real membrane was filtered. It was observed for the real membrane that the pressure was below 100 mbar when the system at stable condition and pressure value rose to levels of 250 mbar. Beside of interrupted suction operation, any physical or chemical washing was not applied.

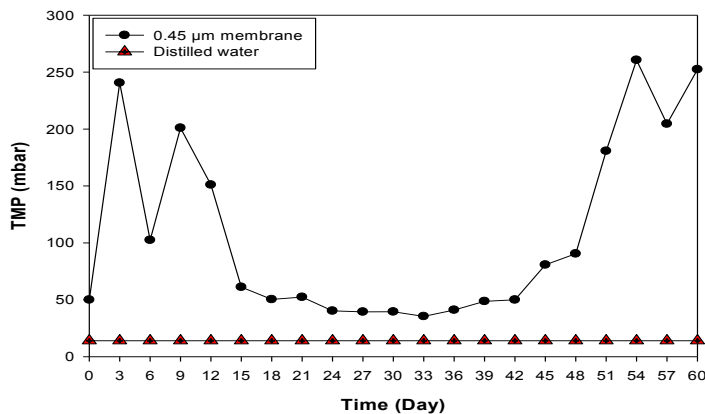

Figure 5: Pressure measurement of the real membrane through MBR operation.

Dynamic membrane was also exposed to interrupted suction operation, 4.5 minutes working and half a minute rest, and 1 minute back washing. In MBR system, synthetic wastewater prepared from non-woven dynamic membrane was filtered and while the system was operating, pressure measurements of dynamic membrane and released distilled water were recorded and represented at Fig. 6. When the measured pressure reached 250 mbar, non-woven dynamic membrane exposed to physical washing. Pressure increment is the result of membrane plugging. During the experiment, physical cleaning was applied three times. Physical cleaning was applied as removal of membrane module and skinning the cake layer from the surface of the membrane. After physical cleaning, significant pressure reduction has been observed. After physical cleaning, increment in pressure is because of the permanent plugging of the pores of the membrane and there are a lot of experiments indicated for this situation.

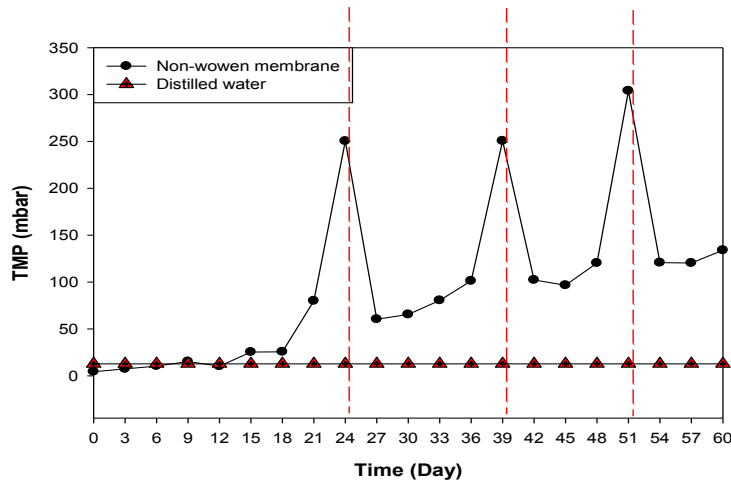

Figure 6: Pressure measurements through MBR operation.

3.2.1 The Effect of Air Backwash

It was only wanted to examine the effect of air backwash for non-woven dynamic membrane, before backwashing and after air backwashing, 12-hour pressure measurement additionally made. Fig. 7 represents the pressure reduction after air backwash. The effect of air backwash has been made for once throughout the MBR operation. TMP values for 30th day were saved with 12-hour period and 2-minute intervals. After 1 minute air backwash operation, TMP values again observed with 12-hour period and effects of air backwash were recorded. Findings showed that air backwash reduced the present TMP value averagely 20%.

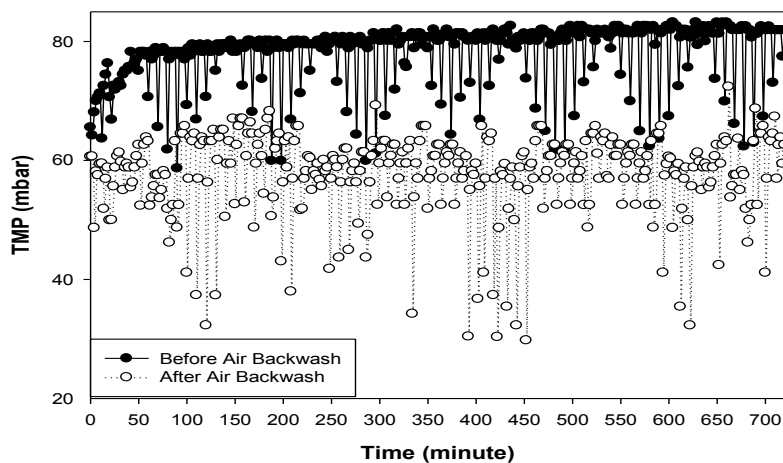

Figure 7: Pressure values before and after air backwash.

3.3 SMP and EPS Results

Throughout the experiment, SMP and EPS analyses were made firstly at day-15 and secondly at day-30. Protein and carbohydrate dependent SMP and EPS concentrations are represented at Table 2. It was noticed that, day-15 SMP and EPS concentrations were higher than the day-30. These results shows gradually heal of COD removal inside of the reactor.

Table 2. SMP and EPS results regarding permeate of dynamic membrane, real membrane and mixed liquor.

Time	Non-woven		0.45 membrane		Supernatant			
	SMP		SMP		SMP		EPS	
	Protein (mg/L)	Carbohydrate (mg/L)	Protein (mg/L)	Carbohydrate (mg/L)	Protein (mg/L)	Carbohydrate (mg/L)	Protein (mg/L)	Carbohydrate (mg/L)
Day 15	0,05989	24,601	0,07567	85,261	0,999	147,943	0,1465	171,533
Day 30	0,18964	59,649	0,27584	195,46	0,431	99,752	0,1379	66,389

At day-15, analyze results of permeate of dynamic and real membrane were lower than the results of day-30. When this situation is examined with the turbidity values of both modules, it can be noticed that COD removal yield is lower than for the first time in days.

3.4 CST Results

CST is used to identify the sludge characteristics and it measures the time of water drop from the sludge moved 1 cm path in a porous membrane. CST results of fully mixed liquor samples are represented at Fig. 8.

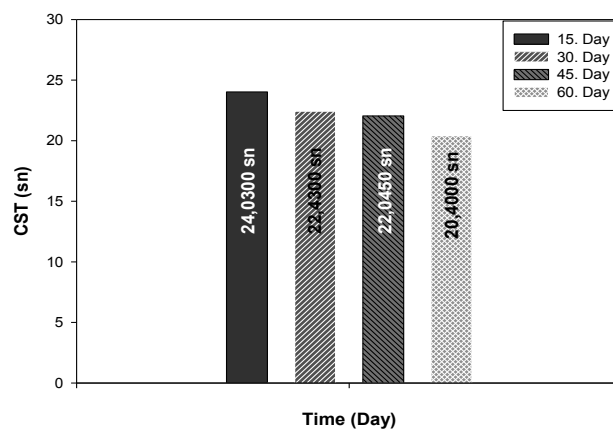

Figure 8: CST analyzes results of the MBR mixed liquor.

CST analyses from day 15, 30, 45 and 60 were found as 24.03 sec., 22.43 sec., 22.045 sec. and 20.40 sec., respectively. Findings showed that CST values are gradually reducing. This shows the increment in viscosity of the sludge in the reactor, and thus demonstrates that the membrane filtration rate gets better.

4.CONCLUSIONS

In this study the comparison of DMBR and MBR was studied. Both membrane types operated under same aerobic conditions such as; volume, LMH and SADm. At the end of approximate one month adaptation time course, bioreactors, which have reached stable conditions, have been operated to gather the data throughout 60 days. COD removal rates and turbidity results have been compared and non-woven dynamic membrane results have shown similar results to real membrane in terms of efficiency. Furthermore, dynamic membrane has exposed air back wash and pressure changes examined.

REFERENCE

- [1] S. Judd, The MBR book. Oxford, Elsevier, 2006.
- [2] G.T.Seo, B.H. Moon, T.S. Lee, T.J. Lim, I.S. Kim, Non-woven fabric filter separation activated sludge reactor for domestic wastewater reclamation. Wat. Sci. Tech., 47(1), 133–138, 2002.

- [3] H. D. Park, I. S. Chang, K. J. Lee, Principles of Membrane Bioreactors for Wastewater Treatment, CRC Press, Taylor&Francis Group, 2015.
- [4] W.Fuchs, C.Resch, M.Kernstock, M. Mayer, P.Scoeberl, R. Braun, Influence of operational conditions on the performance of a mesh filter activated sludge process. *Water Res.* 39 (4), 803–810, 2005.
- [5] Y. Kiso, Y.J. Jung, K.S. Min, W. Wang, M. Simase, T. Yamada. Coupling of sequencing batch reactor and mesh filtration: operational parameters and wastewater treatment performance. *Water Res.* 39, 4887–4898, 2005.
- [6] M.H.Al-Malack and G.K. Anderson, Formation of dynamic membranes with crossflow microfiltration. *J. Membr. Sci.* 112, 287–296, 1996.
- [7] M. Ye, H. Zhang, Q. Wei, H. Lei, F. Yang, X. Zhang, Study on the suitable thickness of a pac-pre-coated dynamic membrane coupled with a bioreactor for municipal wastewater treatment. *Desalination* 194, 108–120, 2006
- [8] C. Wisniewskand A. Grasmick, *Coll Surf A: PhysicochemEng Aspects* 138:403, 1998.
- [9] P.Côté, D. Thompson, *Water SciTechnol* 41:209, 2000.
- [10] Y. Wu, X. Huang, X. Wen, F. Chen, Function of dynamic membrane in selfforming dynamic membrane coupled bioreactor. *Water Sci. Technol.* 51 (6–7), 107–114, 2005.
- [11] L. Chu and S. Li, Filtration capability and operational characteristics of dynamic membrane bioreactor for municipal wastewater treatment. *Sep. Purif. Technol.* 51, 173–179, 2006.
- [12] F. Li, J. Chen, C. Deng, The kinetics of crossflow dynamic membrane bioreactor. *Water SA* 32 (2), 199–203, 2006.
- [13] H.Q. Chu, D. Cao, W. Jin, B.Z. Dong, Characteristics of bio-diatomite dynamic membrane process for municipal wastewater treatment. *J. Membr. Sci.* 325, 271–276, 2008.
- [14] D.W. Cao, H.Q. Chu, W. Jin, B.Z Dong, Characteristics of the biodiatomite dynamic membrane (cake layer) for municipal wastewater treatment. *Desalination* 250, 544–547, 2010.
- [15] D. Jeison, I. Diaz, J.B. van Lier, Anaerobic membrane bioreactors: are membranes really necessary? *Electron. J. Biotech.* 11 (4), 1–7, 2008.
- [16] A.E. Marcinkowsky, K.A. Kraus, H.O. Phillips, J.S. Johnson, A.J. Shor, Hyperfiltration studies IV. Salt rejection by dynamically formed hydrous oxide membranes. *J. Am. Chem. Soc.* 88 (24), 5744–5750, 1966.
- [17] D. Freilich, G.B. Tanny, The formation mechanism of dynamic hydrous Zr(IV) oxide membrane on microporous supports. *J. Colloid Int. Sci.* 64, 362–370, 1978.
- [18] T. Ohtani, M. Nakajima, Y. Nawa, A. Watanabe, Formation of dynamic UF membrane with fine Zr particles. *J. Membr. Sci.* 64, 273–281, 1991.
- [19] M. Rummyantsev, A. Shauly, S. Yiantios, D. Hasson, A. Karabelas, R. Semiat, Parameters affecting the properties of dynamic membranes formed by Zr hydroxide colloids. *Desalination* 131, 189–200, 2000.
- [20] M. Altman, R. Semiat, D. Hasson, Removal of organic foulants from feedwaters by dynamic membranes. *Desalination* 125, 65–75, 1999.
- [21] R.Y. Horng, C. Huang, M.C. Chang, H. Shao, B.L. Shiau, Y.J. Hu, Application of TiO₂ photocatalytic oxidation and non-woven membrane filtration hybrid system for degradation of 4-chlorophenol. *Desalination* 245, 619–182, 2009.
- [22] Y. Zhao, Y. Tan, F.S. Wong, A.G. Fane, N. Xu, Formation of Mg(OH)₂ dynamic membranes for oily water separation: effects of operating conditions. *Desalination* 191, 344–350, 2006.
- [23] J. Y. Lee, S. K. Maeng, B. K. Choi, K. H. Ahn, K. G. So, Characteristics of flux and gel layer on microfilter and non-woven fabric filter surface based on anoxic-aerobic MBRs, *Bioprocess Biosyst Eng.* 35:1389–1398, 2012.
- [24] L. Chu and S. Li, Filtration capability and operational characteristics of dynamic membrane bioreactor for municipal wastewater treatment, *Separation and Purification Technology*, 51, 173–179, 2006.
- [25] X. H. Zhou, H. C. Shi, Q. Cai, M. He, Y. X. Wu, Function of selfforming dynamic membrane and biokinetic parameters determination by microelectrode, *Water Res* 42:2369–2376, 2008.

Isotherm and Kinetic Modelling of Azo Dyes Adsorption

Onur Isik¹, Ibrahim Demir¹, Ahmet Yuceer², Ozer Cinar^{3*}

Abstract

Textile and dye industries' wastewaters are one of the major problem in the water pollution. This wastewater causes serious environmental pollution, because of non-biodegradable and toxic dye molecules. Azo dyes are widely used in the textile industry. In the anaerobic condition azo dyestuff decompose to toxic byproducts. The aim of this work is to understand the adsorption mechanisms of various azo dyestuff adsorbed by domestic wastewater treatment plant inactivated sludge. To determine the adsorption mechanisms, various isotherms and kinetics were used and constants of each isotherms and kinetics were calculated for each dyestuff. In this study, Reactive Black 5 (RB5), Reactive Blue 21 (RB21), Acid Brown 283 (AB283) and Basic Violete 3 (BV3) azo dyestuff adsorption data were used for isotherms and kinetics calculations. The results of this study showed that, the best isotherm which describe the adsorption process was Freundlich. This isotherm model assumes that heterogeneous sorption occurs on adsorbent surface, stated in other words adsorption power varies at every sorption point. For RB5 and AB283 dyes, the best kinetic model which describe the adsorption process was pseudo-second-order kinetic model. This kinetic model assumes that adsorption rate dependent to adsorbent material quantities and contact time.

Keywords: Azo Dyes, Dyestuff Adsorption, Equilibrium Isotherms and Kinetic Models

1. INTRODUCTION

Dye manufacturing is a large industry. There are more than 100,000 commercially available dyes in the world trade market [1]. It is estimated that approximately 1 million tones dyestuff produced annually, and 20-25% of these produced dyestuff is discharged to the receiving environment as waste [2]. Furthermore, Dyes are widely used in many industries, such as textile, packaging industry, automotive industry, food industry, etc. These industries colored wastewaters are caused serious aesthetic and environmental problems. The colored substances prevent the passes of the sun ray into the water. So that, photosynthetic reactions are reduced [3]. Dyes can cause mutagenic and carcinogenic effects on living organisms. At that, dyes can affect brain, central nervous, reproduction system, and organs such as kidney, lung, liver, etc. [4]. The majority of the synthetic dyes are resistant to biological degradation, because of its' complex structures, such as azo dyes [5]. Azo dyes have at least one double bounded nitrogen (N=N), and these dyes are named according to the number of double bounded nitrogen pairs. Azo dyes which have one double bound nitrogen molecules are called monoazo, and azo dyes which have 2 or 3 double bound nitrogen molecules are called diazo or triazo dyes [6]. In the anaerobic conditions, azo dyes are degraded to colorless and toxic aromatic amines [7]. Many physical, chemical and biological techniques have been developed for dye removal. Adsorption is one of the most important techniques for dye removal. Many adsorbents have been as scientifically or commercially tested for dye removal. Peat, activated sludge, coir pith, waste organic peel, tree fern, red mud and minerals can be red given as examples for these adsorbents [8,9,10,11,12,13,14,15]. Biological activated sludge systems are one of the most common treatment method for colored wastewaters, particularly textile industries wastewater treatment [16].

One of the dye remove mechanisms that occur in activated sludge system is adsorption. Adsorbable substances can transferred into the cell, and take a part in metabolic / co-metabolic activities. In this reason, studies on adsorption of dyestuff with activated sludge, and understand of the adsorption mechanisms of dyestuff is important for colored wastewater treatment [9]. Isotherms and kinetic models are important to understand the adsorption mechanisms, identify optimum operation conditions, and design effective treatment systems.

The aim of this work is to understand the adsorption mechanisms of various azo dyestuff adsorbed by domestic wastewater treatment plant inactivated sludge.

¹Department of Environmental Engineering, Istanbul Technical University, 34469, Maslak/Istanbul, Turkey.
onurisik01@hotmail.com

¹Department of Environmental Engineering, Istanbul Technical University, 34469, Maslak/Istanbul, Turkey.
idemir@itu.edu.tr

²Department of Environmental Engineering, Cukurova University, 01330, Saricam/Adana, Turkey.

^{3*} Department of Environmental Engineering, Yildiz Technical University, 34220, Esenler/Istanbul, Turkey.
ozercinar@gmail.com

2. MATERIAL AND METHOD

In this paper, some isotherms and kinetics used to understand Reactive Black 5 (RB5), Reactive Blue 21 (RB21), Acid Brown 283 (AB283) and Basic Violete 3 (BV3) azo dyestuff adsorption mechanisms by domestic wastewater plant inactivated sludge.

Table 1. RB5, RB21, AB283, and BV3 dyes properties

Color Index	RB5	RB21	AB283	BV3
Type	Anyonik	Anyonik	Anyonik	Katyonik
Chemical Property	Reactive	Reactive	Acidic	Basic
Chromophore Group	Azo	Azo	Azo	Azo
CAS	17095-24-8	12236-86-1	12219-66-8	42555
Molecular Weight	991.82	377.43	882.25	407.99
Molecule Formula	C ₂₆ H ₂₁ N ₅ Na ₄ O ₁₉ S ₆	C ₁₈ H ₁₅ N ₇ OS	C ₃₂ H ₁₉ CrN ₈ O ₁₁ .S.H.Na	C ₂₅ H ₃₀ ClN ₃
λ_{maks}	579	626	328	590

The adsorption data used in the modeling was taken from a MS. Thesis of the year 2014 [17]. The material and method part can be stated in this MS. Thesis. To sum up, adsorption experiments were performed at room temperature, and the study was conducted at different concentrations of initial dye concentrations.

3. RESULTS AND DISCUSSION

3.1. Adsorption Isotherms

Adsorption isotherms demonstrate adsorption phenomena during the adsorption process reaches an equilibrium state [18]. Design parameters can be determined fitting isotherm data to different isotherm models [19]. Adsorption isotherm is show the interaction between solutes and adsorbents. It is important for optimizing the use of adsorbents [18].

Langmuir, Freundlich, Temkin and Dubinin-Radushkevich isotherms were used in this study.

3.1.1. Langmuir Isotherm

Langmuir isotherm model assumes that adsorbent surface has adsorptive points and each point can adsorb one molecule. So that, mono layer occurred on the adsorbent and the layer disperse homogenous [18,20]. Langmuir isotherm equation linearized form is given as:

$$\frac{q_e}{C_e} = K_L q_{max} + K_L q_e \quad (1)$$

where; C_e is the equilibrium concentration of adsorbate in solution (mg/L), q_e is the equilibrium solid phase concentration (mg/g), K_L is the Langmuir constants. C_e/q_e data is plotted against C_e to calculate K_L and q_{max} [21,22].

3.1.2. Freundlich Isotherm

Freundlich isotherm model assumes that heterogeneous sorption occurs on adsorbent surface, stated in other words adsorption power varies at every sorption point [23]. Freundlich isotherm equation linearized form is given as:

$$\log(q_e) = \log K_f + \left(\frac{1}{n}\right) \log C_e \quad (2)$$

where; C_e is the equilibrium concentration of adsorbate in solution (mg/L), q_e is the equilibrium solid phase concentration (mg/g), K_f and n are Freundlich constant. K_f (L/mg) represents the quantity of dye adsorbet onto adsorbent for a unit equilibrium concentration. n (unitless) shows that the degree of favourability of adsorption. $1/n$ value change between 0 and 1. Surface heterogeneity increase as $1/n$ value gets closer to zero. $\log q_e$ data is plotted against $\log C_e$ to calculate K_f and $1/n$ [18,22,24].

3.1.3. Tempkin Isotherm

Tempkin isotherm model is evaluated interactions between adsorbed substances. This isotherm assumed that heat of adsorption decreases linearly with coverage due to adsorbate/adsorbent interactions [18,25]. Tempkin isotherm equation linearized form is give as:

$$q_e = \frac{RT}{b_T} \ln K_T + \frac{RT}{b_T} \ln C_e \quad (3)$$

where; C_e is the equilibrium concentration of adsorbate in solution (mg/L), q_e is the equilibrium solid phase concentration (mg/g), $1/b_T$ corresponds to the adsorption potential of the adsorbent (J/mol), K_T is the Tempkin isotherm constant (L/g), T is temperature (Kelvin) and R gas constant (8.314 J/mol.K). q_e data is plotted against $\ln C_e$ to calculate K_T and b_T [26].

3.1.4. Dubinin-Radushkevich Isotherm

Dubinin-Radushkevich isotherm model is based on the micro pore volume filling theory. This isotherm assumes that multilayer adsorption mechanisms [27]. Dubinin-Radushkevich isotherm equation linearized form is given as:

$$\ln q_e = \ln q_{max} + B_D \varepsilon^2 \quad (4)$$

where; q_e is the equilibrium solid phase concentration (mg/g), q_{max} is the maximum solid phase concentration (mg/g), B_D is free energy adsorption constant. To calculate the equation (4) the initial value of ε must be calculated with the below equation:

$$\varepsilon = RT \ln \left(1 + \frac{1}{C_e} \right) \quad (5)$$

where; C_e is the equilibrium concentration of adsorbate in solution (mg/L), T is temperature (Kelvin) and R gas constant (8.314 J/mol.K). $\ln q_e$ data is plotted against ε^2 to calculate B_D and q_{max} . Equation (6) is applied after the B_D value find. In equation (6), E refers to free energy [27]:

$$E = \frac{1}{\sqrt{2B_D}} \quad (6)$$

If the free energy value range between 1-8 kJ/mol, Van der Waals forces are effective and physical adsorption is happened. If free energy value greater than 8 kJ/mol, chemical adsorption is happened [28].

Evaluation of Isotherms:

Calculated isotherm parameters summarized on the Table 2 for RB5, RB21, AB283 and BV3 dyes. The results on the Table 2 show that, the best isotherm which describe the adsorption process was Freundlich for all dyes, because of the higher regression coefficient (R^2) values. This isotherm model assumes that heterogeneous sorption occurs on adsorbent surface, stated in other words adsorption power varies at every sorption point. Moreover, calculated "1/n" values were range between 0.378-0.957 ($1/n < 1$). Its mean that chemical adsorption happened. Chemical adsorption is generally irreversible. For AB283 dye, calculated regression coefficient of Tempkin isotherm ($R^2=0.991$) was very high. It means that the heat of adsorption decreased linearly with coverage due to adsorbate/adsorbent interactions, so we assume that the adsorption process of AB283 by inactivated sludge is an endothermic reaction.

Table 2. Isotherms parameters of RB5, RB21, AB283 and BV3 dyes

Isotherm	Parameters	RB5	RB21	AB283	BV3
Langmuir	q_{max}	2.956	-0.00295	0.0376	888
	K_L	0.0285	-0.0006	0.0237	0.0063
	R^2	0.715	0.0243	0.875	0.089
	$1/n$	0.378	0.957	0.625	0.930
Freundlich	K_F	3.01	0.247	3.128	6.045
	R^2	0.964	0.950	0.960	0.989
	b_t	3655	213	172	83
Tempkin	K_T	5.390	0.060	0.248	0.607
	R^2	0.915	0.836	0.991	0.865
Dubinin-Raduskevich	q_{max}	2.03	16.665	33.36	47.375
	B_D	$8 \cdot 10^{-5}$	$9 \cdot 10^{-5}$	$2 \cdot 10^{-5}$	$1 \cdot 10^{-5}$
	R^2	0.663	0.671	0.904	0.771

3.2. Adsorption Kinetics

Intraparticle diffusion model, Lagergren kinetic model, Pseudo second order kinetic model and Elovich kinetic model were used in this study. BV3 dye reached equilibrium point in 1 minute. So, BV3 dye data could not use in the kinetic models.

3.2.1. Intraparticle Diffusion Model

Intraparticle diffusion model assumes that adsorbate substances in solution enter the pores which are state at the adsorbent, and hold on the surface of the pores [29,30]. Intraparticle diffusion equation is given as:

$$q_t = k_p t^{0.5} \quad (7)$$

where; q_t is the amount of material collected on the adsorbent during the t time (mg/g), t is the time (minute), k_p is the intraparticle diffusion rate constant. q_t data is plotted against $t^{0.5}$ to calculate k_p [31,22].

Table 3. Intraparticle diffusion model parameters of RB5, RB21 and AB283 dyes

Initial Dye Concentration	Parameters	RB5	RB21	AB283
25 mg/L	R^2	0.994	0.974	0.961
	K_L (mg/g.min ^{0.5})	0.323	1.053	2.396
50 mg/L	R^2	0.973	0.968	0.979
	K_L (mg/g.min ^{0.5})	0.363	1.413	4.933
75 mg/L	R^2	0.978	0.994	0.958
	K_L (mg/g.min ^{0.5})	0.4513	1.834	6.002

100 mg/L	R ²	0.9821	0.995	0.964
	K _L (mg/g.min ^{0.5})	0.5327	3.013	7.893
150 mg/L	R ²	0.988	0.991	0.950
	K _L (mg/g.min ^{0.5})	0.6828	4.197	9.67

Intraparticle diffusion model parameters' calculated and summarized on the Table 3 for RB5, RB21 and AB283 dyes. High regression coefficient values proved that the intraparticle diffusion theory is valid for all these dyes. It can be assumed, the adsorbent substances which come to the adsorbent pores were entered the pores and kept the pore surface.

3.2.2. Lagergren (First Order) Kinetic Model

Lagergren equation is used to evaluate the relationship between adsorption rate and adsorption capacity [32]. This model generally in compliance with low adsorbent concentration process [33]. Lagergren kinetic model equation is given as:

$$\log \frac{q_e - q_t}{q_e} = - \frac{k_1 t}{2.303} \quad (8)$$

where; q_e is the equilibrium solid phase concentration (mg/g), q_t is the amount of material collected on the adsorbent during the t time (mg/g), k_1 is the Lagergren rate constant adsorption (min^{-1}), t is the time (min) [34, 18].

Table 4. Lagergren kinetic model parameters of RB5, RB21 and AB283 dyes

Initial Dye Concentration	Parameters	RB5	RB21	AB283
25 mg/L	R ²	0.996	0.934	0.962
	K _L (min^{-1})	0.171	0.149	0.150
50 mg/L	R ²	0.997	0.968	0.857
	K _L (min^{-1})	1.170	0.103	0.220
75 mg/L	R ²	0.981	0.981	0.922
	K _L (min^{-1})	0.210	0.0744	0.189
100 mg/L	R ²	0.976	0.996	0.897
	K _L (min^{-1})	0.216	0.076	0.171
150 mg/L	R ²	0.919	0.997	0.893
	K _L (min^{-1})	0.231	0.073	0.157

Lagergren kinetic model parameters' calculated and summarized on the Table 4 for RB5, RB21 and AB283 dyes. Calculated regression coefficient values for RB21 were increased in direct proportion to initial dye concentration. However, RB5 and AB283 dyes regression coefficient values were decreased depending on the increase initial dye concentration. So, it can be said that Lagergren kinetic model is available for RB21 dye.

3.2.3. Pseudo Second Order Kinetic Model

This kinetic model assumes that adsorption rate dependent to adsorbent material quantities and contact time [35]. This kinetic model equation linearized form is given as:

$$\frac{1}{q_t} = \frac{1}{q_e} + \left(\frac{1}{k_2 q_e^2} \right) \frac{1}{t} \quad (9)$$

where; q_e is the equilibrium solid phase concentration (mg/g), q_t is the amount of material collected on the adsorbent during the t time (mg/g), k_2 is the pseudo second order rate constant (g/mg.min), t is the time (minute) [36,37].

Pseudo second order kinetic model parameters' calculated and summarized on the Table 5 for RB5, RB21 and AB283 dyes. Calculated regression coefficient values for RB5 and AB283 were increased in direct proportion to

initial dye concentration. However, RB21 dye regression coefficient values were decreased depending on the increase initial dye concentration. So, it can be said that adsorption rate of RB21 and AB283 dependent to adsorbent material quantities and contact time.

Table 5. Pseudo Second Order kinetic model parameters of RB5, RB21 and AB283 dyes

Initial Dye Concentration	Parameters	RB5	RB21	AB283
25 mg/L	R ²	0.990	0.958	0.922
	K _L (g/mg.min)	0.078	0.085	0.034
50 mg/L	R ²	0.998	0.990	0.909
	K _L (g/mg.min)	0.087	0.020	0.061
75 mg/L	R ²	0.996	0.976	0.964
	K _L (g/mg.min)	0.169	0.009	0.026
100 mg/L	R ²	0.994	0.978	0.964
	K _L (g/mg.min)	0.163	0.005	0.018
150 mg/L	R ²	0.898	0.991	0.971
	K _L (g/mg.min)	0.237	0.002	0.011

3.2.4. Elovich Kinetic Model

Elovich kinetic model has been determined the kinetics of the adsorption and desorption of inorganic substances on solid surface [38]. This kinetic model assumes that the solid (adsorbent) surface is heterogeneous, and adsorption kinetic not affected the low adsorption/desorption interaction [39]. This kinetic model equation linearized form is given as:

$$q_t = \frac{1}{\beta} \ln(\alpha\beta) + \frac{1}{\beta} \ln t \quad (10)$$

where; q_t is the amount of material collected on the adsorbent during the t time (mg/g), t is the time (minute), α is the adsorption rate constant (mg/g.min). β is a constant related with to expand the activation energy for chemical sorption and the surface coverage (g/mg). q_t data is plotted against $\ln t$ to calculate α and β [40,41].

Elovich kinetic model parameters' calculated and summarized on the Table 5 for RB5, RB21 and AB283 dyes. High regression coefficient values proved that the Elovich kinetic model is valid for all these dyes. It can be assumed that desorption phenomena does not occur, and adsorption rate decrease with the coverage of adsorbent surface.

Table 6. Elovich kinetic model parameters of RB5, RB21 and AB283 dyes

Initial Dye Concentration	Parameters	RB5	RB21	AB283
25 mg/L	R ²	0.979	0.998	0.971
	α (mg/g.min)	0.486	17.121	22.623
	β (g/mg)	2.547	1.442	0.598
50 mg/L	R ²	0.994	0.992	0.992
	α (mg/g.min)	0.663	0.973	89182
	β (g/mg)	2.300	0.579	0.785
75 mg/L	R ²	0.996	0.967	0.988
	α (mg/g.min)	2.180	2.264	948
	β (g/mg)	2.809	0.319	0.397
100 mg/L	R ²	0.997	0.985	0.998
	α (mg/g.min)	3.237	3.460	604
	β (g/mg)	2.557	0.183	0.272
150 mg/L	R ²	0.967	0.989	0.985
	α (mg/g.min)	17.125	4.459	186
	β (g/mg)	2.796	0.119	0.176

Elovich kinetic model parameters' calculated and summarized on the Table 5 for RB5, RB21 and AB283 dyes. High regression coefficient values proved that the Elovich kinetic model is valid for all these dyes. It can be assumed that desorption phenomena does not occur, and adsorption rate decrease with the coverage of adsorbent surface.

4.CONCLUSION

The study was carried out to understand adsorption mechanisms of RB5, RB21, AB283 and BV3 dyes. Four different isotherms and four different kinetics were used and constants of each isotherms and kinetics were calculated for each dyestuff. The best isotherm which describe the adsorption process was Freundlich isotherm. The best kinetic model which has the highest regression coefficient values was Pseudo second order kinetic model for RB5 and AB283 dyes and Lagergren kinetic model for RB21 dye.

REFERENCE

- [1] J.W. Lee, S.P. Choi, R. Thiruvengkatchari, W.G. Shim, H. Moon, Evaluation of the performance of adsorption and coagulation processes for the maximum removal of reactive dyes, *Dyes Pigments*, 69 (2006) 196–203.
- [2] A.B. dos Santos, F.J. Cervantes, J.B. van Lier, Review Paper on Current Technologies for Decolourisation of Textile Wastewaters: Perspectives for Anaerobic Biotechnology. *Bioresource Technology*, 98 (2007) 2369-2385.
- [3] A.A. Attia, B.S. Girgis, N.A. Fathy, Removal Of Methylene Blue Bycarbons Derived From Peach Stones By H3PO4 Activation: Batch And Columnstudies. *Dyes And Pigments*, (2008) 282-289.
- [4] M.A.M. Salleh, D.K. Mahmoud, W.A. Karim, A. Idris, Cationic and anionic dye adsorption by agricultural solid wastes: A Comprehensive review. *Desalination*, 280 (2011) 1-13.

- [5] Stolz, Basic and applied aspects in the microbial degradation of azo dyes. *Appl. Microbiol. Biotechnol.* 56 (2001) 69–80.
- [6] H. Zollinger, *Synthesis, Properties and Applications of Organic Dyes and Pigments*. Weinheim, (1991) 367p.
- [7] O. Cinar, K. Demiroz, Biodegradation of Azo Dyes in Anaerobic–Aerobic Sequencing Batch Reactors, *Handbook Environmental Chem., Biodegradation Azo Dyes*, (2010) 215.
- [8] Y.S. Ho, G. McKay, *Chemical Eng. J.*, 70 (1998) 115.
- [9] M. Basibuyuk, C.F. Forster, An Examination of Adsorption Characteristics of A Basic Dye (Maxilon Red BL-N) on to Live Activated Sludge System, *Process Biochemistry*, 38 (2013) 1311-1316.
- [10] C. Namasivayam, R. Radhika, S. Suba, *Waste Manag.*, 1 (2001) 381.
- [11] C. Namasivayam, N. Muniyasamy, K. Gayatri, M. Rani, *Bioresour. Technol.*, 57(1996) 37.
- [12] Y.S. Ho, T.H. Chiang, Y.M. Hsueh, *Process. Biochem.*, 40 (2005) 119.
- [13] C. Namasivayam, D. Arasi, *Chemosphere*, 34 (1997) 401.
- [14] A.S. Ozcan, A. J. Ozcan, *Colloid. Interf. Sci.*, 276 (2004) 39.
- [15] B. Meroufel, O. Benali, M. Benyahia, Y. Benmoussa, M.A. Zenasni, Adsorptive removal of anionic dye from aqueous solutions by Algerian kaolin: Characteristics, isotherm, kinetic and thermodynamic studies, *J. Mater. Environ. Sci.* 4 (3) (2013) 482-491.
- [16] M. Basibuyuk, C.F. Forster, The Use of Sequential Anaerobic/Aerobic Process for the Biotreatment of A Simulated Dying Wastewater, *Environmental Technology*, 28 (1997) 843-845.
- [17] O. Isik, Inaktif Camurla Cesitli Boyar Maddelerin Adsorpsiyonu, MS Thesis, Cukurova University, Institute of Natural and Applied Sciences, 2014, Adana.
- [18] I.A.W. Tan, B.H. Hamed, A.L. Ahmad, Equilibrium and kinetic studies on basic dye adsorption by oil palm fibre activated carbon, *Chemical Eng. J.*, 127 (2007) 111-119.
- [19] M. El-Guendi, Homogeneous surface diffusion model of basic dyestuffs onto natural clay in batch adsorbers, *Adsorpt. Sci. Technol.*, 8 (2) (1991) 217–225.
- [20] B. Balci, Atıksulardan Bisfenol-A Gideriminde Biyotik ve Abiyotik Süreçlerin Araştırılması. Doktora Tezi, Çukurova Üniversitesi Fen Bilimleri Enstitüsü, 2014, Adana.
- [21] Langmuir, *J. Am. Chem. Soc.*, 40, 1361 (1918)
- [22] O. Keskinan, B. Balci, Adsorptive Removal of Dyes Using Crude Tree Barks: Equilibrium Isotherm and Kinetics, *Asian J. of Chem.*, 25 (8) (2013) 4693-4698.
- [23] M.S. Chiou, H.Y. Li, Equilibrium And Kinetic Modeling of Adsorption of Reactive Dye on Cross-Linked Chitosan Beads. *Journal of Hazardous Materials*, 93(2) (2002) 233-248
- [24] F. Haghseresh, G. Lu, Adsorption characteristics of phenolic compounds onto coal-reject-derived adsorbents, *Energy Fuels*, 12 (1998) 1100–1107.
- [25] J. Febrianto, A.N. Kosasih, J. Sunarso, Y.H. Ju, N. Indraswati, S. Ismadji, Equilibrium and kinetic studies in adsorption of heavy metals using biosorbent: a summary of recent studies. *Journal of Hazardous Materials*, 162 (2009) 616–645.
- [26] J.F. Farah, Nour Sh. El-Gendy, Performance, Kinetics and Equilibrium in Biosorption of Anionic Dye Acid Red 14 by the Waste Biomass of *Saccharomyces cerevisiae* as a Low-Cost Biosorbent. *Turkish J Eng Env Sci.*, 37 (2013) 146-161.
- [27] Dabrowski, *Adsorption-From Theory To Practice. Advances in Colloid and Interface Science*, 93 (2001) 135-224.
- [28] A.H. Chen, S.M. Chen, Biosorption of Azo Dyes from Aqueous Solution Byglutaraldehyde-Cross Linked Chitosans, *Journal Hazardous Material*, 172 (2009) 1111-1121.
- [29] H.C. Chu, K.M. Chen, Reuse of Activated Sludge Biomass: I. Removal of Basic Dyes from Wastewater By Biomass. *Process Biochemistry*, 37 (2002) 595-600.
- [30] O. Keskinan, A. Yuceer, M.Z.L. Goksu, M. Basibuyuk, C.F. Forster, Heavy metal adsorption characteristics of a submerged aquatic plant (*Myriophyllum spicatum*). *Process Biochemistry*, 39 (2003) 179-183.
- [31] W.J. Weber, J.C. Morris, *J. Sanit. Eng. Div. Am. Soc. Civ. Eng.*, 89 (1963) 31.
- [32] Y. Song, Y. Du, D. Lu, G. Ye, J. Wang, Macrocyclic receptors immobilized to monodisperse porous polymer particles by chemical grafting and physical impregnation for strontium capture: A comparative study. *Journal of Hazardous Materials*, 274 (2014) 221-228.
- [33] W. Hassan, U. Farooq, M. Ahmad, M. Athar, M.A. Khan, Potential biosorbent, *Haloxylon Recurvum* plant systems, for the removal of methylene blue dye. *Arabian Journal of Chemistry* (2013).
- [34] S. Langergren, B.K. Svenska, Zur theorie der sogenannten adsorption gelöster stoffe, *Veternskapskad Handlingar* 24 (4) (1898) 1–39.
- [35] H. Ghodosi, J. Farhoudi, M.H. Omid, A. Mahdavi, Mazdeh, Comparison of different methods for linear regression of pseudo second order adsorption kinetics of cadmium. *Journal of Civ. Eng. and Urb.* 3, Issue 2 (2013) 73-76.
- [36] Y.S. Ho, G. McKay, Sorption of dye from aqueous solution by peat, *Chem. Eng. J.*, 70 (1998) 115–124.
- [37] N. Ghasemi, P. Tamri, A. Khademi, N.S. Nezhad, ALWI, Alwi, Linearized equations of pseudo second-order kinetic for the adsorption of Pd(II) on *Pistacia Atlantica* Shells. *IERI Procedia*, 5 (2013) 232-237.
- [38] D.L. Sparks, *Environmental Soil Chemistry*. Academic Press, Second Edition, 350 p., 2002, USA.
- [39] S.S. Gupta, K.G. Bhattacharyya, Kinetics of adsorption of metal ions on inorganic materials: A review. *Advances in Colloid and Interface Science*, 162 (1–2) (2011) 39–58.
- [40] Y.S. Ho, G. McKay, Comparative Sorption Kinetic Studies of Dye and Aromatic Compounds onto Fly Ash. *J. Environ. Sci. Health*, A34 (35) (1999) 1179-1204.
- [41] F.E. Erkurt, B. Balci, Investigation of Adsorption of Reactive Black 5 Dye onto Activated Carbon by Using Kinetic and Adsorption Models, *Cukurova Uni. J. of the Faculty of Engi. And Arch.*, 30(1) (2015) 257-269.

Investigation on the characteristics and management of dental wastewater in Tehran, Iran

Majid Bahramian¹, Ozer Cinar², Naser Mehrdadi³, Mehmet Akif Verat⁴

Abstract

The objective of this study was to identify the components, composition, generation rate and management of dental wastewater in Tehran, Iran. Five dental centers in district 6 of Tehran selected from twenty-eight centers using Kukran random sampling formula. Three samples were taken from each center daily and sent to laboratory for relevant analyses. The mean value for pH, COD, EC, TDS, TSS, temperature and turbidity was 6.72 ± 0.009 , 241.25 ± 75.87 mg/l, 1593.75 ± 75.11 μ s/cm, 1282.25 ± 53.64 mg/l, 220 ± 77.45 mg/l, 17.15 ± 0.69 °c and 39 ± 11.69 FTU. The qualitative analyzes declares that the mean concentration of dissolved silver is higher than other metals while tin has the minimum concentration. The mean dissolved concentration for Mercury, Silver, Zinc, Tin and cooper was 25.74 ± 3.79 , 44.22 ± 32.59 , 10.12 ± 5.93 , and 0.20 ± 0.05 and 0.84 ± 0.09 μ g/l, respectively. According to previous studies dental clinics mostly do not use amalgam filtration and pre-treatment systems, so a significant amount of heavy metals discharge to municipal wastewater both in the form if dissolved or particle elements. The quantitative analyze shows that the mean generated wastewater in units using water suction machine is much higher than the respective amount generated in units with surgery suction machine. Due to the lack of the filtration unit and amalgam separator a high concentration of mercury observed which can be reduced by 90% using filtration unit. Based on the discharge standards and destructive effects of this type of wastewater on environment and food chain, it is suggested that dental wastewaters should be treated before entering the municipal wastewater collection systems.

Keywords: Dental wastewater, Mercury pollution, Amalgam, Metals, Wastewater treatment plants

1. INTRODUCTION

Dental amalgam is of concern because almost half of its mass is mercury; a metal that is very mobile in the environment, biologically accumulates in food chain, and has well documented health risks [16][3][7][8][9]. Amalgam Mercury contributes to 5% total Mercury emission which in the case of accumulation by the Mercury of laboratories and health centers this amount can reach 53% [21]. The basic ingredients of amalgam, by weight, are silver (20 – 34%), tin (8 – 15%), copper (1 – 15%), other metals (0 – 5%), and mercury, which comprises 42 – 52% of the total mass [2]. Dental amalgams contribute to 33% of Mercury in municipal wastewaters which in the case of discharge to wastewater collection systems could cause to environmental pollution and sedimentation in the collection pipes [1]. Accordingly, dental clinics are considered as a major source of mercury discharges to the environment [10][13]. Due to its hazardous nature, mercury was globally regulated. Amalgam separators, also called ASD (amalgam separator devices), mercury traps, or MRU (mercury recovery unit), have been introduced to minimize the quantities of mercury (Hg) emitted via waste water from dental clinics. These emissions will continue also after a transition to Hg free dental materials, due to repair, polishing and removal of existing amalgam fillings, and because of the emission of particles from sediments already deposited in tubing systems [4]. having low price to other materials (eg composites), the effective protection of tooth structure, resistant to abrasion and long durability, strong bonding to the tooth, flexibility and usability for all ages are several advantages that makes broad market for amalgam [4]. In new amalgam units, amalgam separator placed before device output in order to prevent any touch or mixture of mercury with wastewater collection system. The amalgam separator is placed in the suction (vacuum) system designed as either a dry or a wet type system [8]. A wet system is characterized by the transportation of air and fluid from the dental unit (dental chair) to a central tank, where the air is separated from fluid. The fluid then enters an amalgam separator before it is passed on. In the so-called dry system, air and liquid is separated within the dental unit, and the amalgam separator is, generally, integrated within the unit. Amalgam separators with suction system are able to collect particles up to 0.4 mm. these separators contain either a replaceable filter or a detachable unit which can be replaced by a new one. An assortment of amalgam separation equipment is available in the market

¹ Yildiz Technical University, Department of Environmental Engineering, 34220, Esenler/Istanbul, Turkey
majidbahramian401@gmail.com

² Corresponding author: Yildiz Technical University, Department of Environmental Engineering, 34220, Esenler/Istanbul, Turkey.
ocinar@yildiz.edu.tr

³ University of Tehran, Graduate Faculty of Environmental Sciences, 54, Azadi, Tehran, Iran, mehrdadi2@yahoo.com

⁴ Yildiz Technical University, Department of Environmental Ebgineering, 34220, Esenler/Istanbul, Turkey veralakif@gmail.com

place with wide ranges in both cost and complexity [5][2][11]. This study evaluates the quality of the generated wastewater in dental offices located in the district 6 of the Tehran municipality in terms of heavy metals specially Hg as its environmental aspects have recently become an important issue for dentistry.

2. METHODOLOGY

2.1 Location of study

This study was conducted on the dental centers of district 6 of Tehran city, located in the north of Iran, in 2014. In Tehran with the population of 7896541 citizens, there are 478 general clinics (public and private), 251 doctor offices and 140 hospitals. 166 specialized dental clinics have been registered among which 28 of them located in district 6 of Tehran municipality. There are nine dental specialties in Iran including endodontics, oral and maxillofacial pathology, oral and maxillofacial radiology, dental implantation, oral and maxillofacial surgery, orthodontics, pediatric dentistry, periodontics, and prosthodontics. One of or any of these activities is done in each specialist dental offices and dental clinics, respectively. Five clinics selected based on Kukran random sampling formula.

2.2 Sample collection and analysis

By Visiting clinics and providing the required information (number of patients per day , the number of units in each section , type amalgam used, filter type , the presence of septic tanks, sewage discharge type) in form of questionnaire, the relevant samples collected and labeled. Earlier studies indicate that the Hg content of the wastewater varies widely during the course of a day. This is why sampling limited volume wastewater, separately or in series, was not considered relevant. Therefore, collecting and sampling all waste water on several working days was judged to be the best sampling approach, as is also done in an American verification of amalgam separators [20]. From each office, three samples were taken at the end of successive working day and kept in polyethylene containers in laboratory for one day. Since the establishment and deployment of laboratory equipment in dental clinics was not possible, the samples kept at 4 °c for maximum four weeks. Besides, to reduce the temperature effect on samples while transforming from the location of sampling to laboratory, sampling procedure conducted in cold seasons of the year (autumn). To minimize analyses loss during collection and storage, nitric acid solution (50% v/v) was added to the samples to maintain a solution with pH below 2. Physical and chemical parameters were conducted based on standard methods and then statically analyzed.

Table 1. Wastewater discharge standards (Iranian Association of Environmental Protection, 2012)

Pollutant	Discharge to surface waters (mg/lit)	Discharge to cesspools (mg/lit)	Agricultural and Sanitation Usage (mg/lit)
Ag	1	0.1	0.1
Cu	1	1	0.2
Hg	0.01	0.01	0.01
Zn	2	2	2
COD***	60	60	200
DO	2	-	2
TDS	*	**	-
TSS	40	-	100
pH	6.5-8.5	5-9	6-8.5
NTU	50	-	50
TCU	75	75	75
°c	****	-	-

* Discharge with higher concentration only allowed when the effluent would not be able to increase the concentration of Cl^- , SO_4^{2-} and dissolved elements by 10% in radius of 200m.

** Discharge with higher concentration only allowed when the increase in concentration of CL^- , SO_4^{2-} and solvents would not cross 10% proportional to consumption water.

*** Industries are allowed to reduce BOD_5 and COD at least by 90%.

**** Temperature must be in the level in which it would not be able to increase or decrease the temperature of accepting source by 3°C.

2.3 Materials and equipment

Chemical characteristics of wastewater (pH, COD, turbidity, EC, TDS and TSS) were measured in the laboratory of environmental science in the University of Tehran. [Table 2](#) shows the standards methods and facilities used for the analyses. Augment activities were investigated by means of a structured questionnaire.

Table 2. Standard methods and facilities

Parameter	Standard Method	Unit	Facility	Model
pH	ASTM D-1293	-	pH meter	Metrohm 691
Turbidity	SM 210	FTU	Turbidity meter	HACH DR/2000
EC	SM 2510	µs/cm	Conductivity meter	inoLab Cond 7110
T	SM 2550	°c	Thermometer	Metrohm 691
TDS	SM 2540	mg/lit	-	inoLab Cond 7110
TSS	HACH method 8006	mg/lit	Spectrophotometer	-
COD	SM 5220	mg/lit	Spectrophotometer	HACH DR 500
Hg	ASTM 1976	µg/lit	ICP	Varian 710
Ag	ASTM 1976	µg/lit	Atomic Absorption	Varian AAS-240
Zn	ASTM 1976	µg/lit	Atomic Absorption	Varian AAS-240
Sn	ASTM 1976	µg/lit	ICP	Varian 710
Cu	ASTM 1976	µg/lit	Atomic Absorption	Varian AAS-240

3 RESEULTS AND DISCUSSION

Due to involvement of the various parameters in the quantity and quality of wastewater such as difference in restoration time, type of tooth decay, suction systems, performance of units and materials, a great difference in quality and quantity of wastewaters has been observed. [Table 3](#) represents the total wastewater generated by each clinic in a successive working day.

Table 3. Quantitative parameters of generated wastewaters in 5 clinics

Clinic	Work Hours	Number of Units	Number of patients in a day	Wastewater production(lit/person)	Generated wastewater(Lit)
1	7:30-15:30	14	10	2.6	26
2	18-21	2	2	1.8	3.6
3	8-17	8	6	300	1800
4	9-14 16-20	5	6	2.1	12.5
5	16-21	4	5	0.6	3

Units in the clinics from 1 to 4 do not use filtration and in clinic number 1 due to the age of filter and lack of regulated discharge, the filter didn't show the expected performance. In clinic 5 for restoration operation, surgery suction has been used so the volume of the generated wastewater is so low in contrast to other clinics. Table 3 illustrates the concentration of qualitative parameters in clinics 1 to 4.

Table 4. Qualitative analyses of effluents

Parameter	Unit	Mean Value	Minimum	Maximum	Standard Deviation
pH	-	6.72	6.6	6.8	0.095
Turbidity	FTU	39	26	52	11.69
EC	µs/cm	1593.75	1490	1670	75.87
T	°c	17.15	16.5	17.8	0.69
TDS	mg/lit	1282.25	1210	1339	53.64
TSS	mg/lit	220	110	290	77.45
COD	mg/lit	241.25	165	344	75.11
Hg	µg/lit	25.74	21.03	29.4	3.79
Ag	µg/lit	44.22	15.40	89.06	32.59
Zn	µg/lit	10.12	6.2	18.87	5.93
Sn	µg/lit	0.2	0.15	0.26	0.05
Cu	µg/lit	0.84	0.74	0.93	0.09

Table 5. Assessment of COD concentration based on the EPA discharge standards

Clinic	Value (mg/lit)	Surface Water	Cesspools	Agricultural Usage	Status
1	238				Unfavorable
2	344				Unfavorable
3	165	60	60	200	Unfavorable
4	218				Unfavorable
5	900				Unfavorable

Table 6. Assessment of mercury concentration based on the EPA discharge standards

Clinic	Value (mg/lit)	Surface Water	Cesspools	Agricultural Usage	Status
1	29.4				Unfavorable
2	21.03				Unfavorable
3	28.13	Inconsiderable	Inconsiderable	Inconsiderable	Unfavorable
4	24.39				Unfavorable
5	33.31				Unfavorable

Table 7. Assessment of silver concentration based on the EPA discharge standards

Clinic	Value (mg/lit)	Surface Water	Cesspools	Agricultural Usage	Status
1	25.77				Unfavorable
2	46.64				Unfavorable
3	15.40	1000	100	100	Unfavorable
4	89.06				Unfavorable
5	417.30				Unfavorable

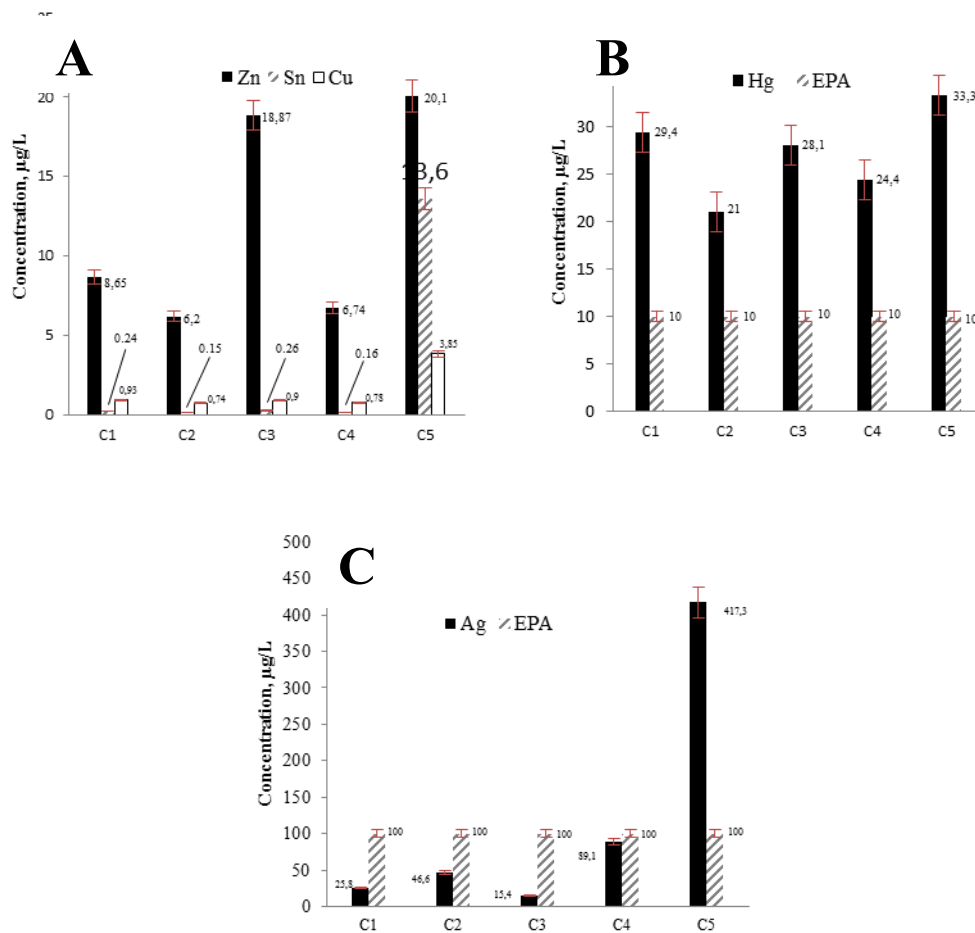

Figure 2. Excel bar graphs for the average concentrations (µg/L) of metals in wastewater samples of dental clinics. (A) Zn, Sn and Cu (B) Hg and EPA standard limit for mercury (C) Ag and EPA standard limit for Silver. C1: Bozorgmehr (clinic 1), C2: Yusef abad Health Centre (clinic 2), C3: Vesal dental clinic (clinic 3), C4: Fathi Shagagi dental center (clinic 4) and C5: Valiasr dental center (clinic 5).

The findings of this study are in line with the results reported in the literature where unacceptable levels of mercury in wastewater of dental clinics were documented [6][13][2][7][14][18][11][1]. The mean generated wastewater was 1.77 ± 0.85 per capita/day. Lit. In one of these clinics due to unit burnout with assumption of 30 minutes for restoration, 300 lit/per capita wastewater generated. District 6 of Tehran municipality doesn't have wastewater collection system. For this Tehran Wastewater Cooperation is now employing policies and longtime plans to study the feasibility of implementation of wastewater collection system. Right now domestic wastewater and the wastewater from health services are deposited in cesspools. As tables 5, 6 and 7 shows chemical parameters of generated wastewaters in dental clinics are higher than permitted value to be discharged to cesspools. On the other hand, these effluents also are not allowed to be discharged to rivers. Current practices have demonstrated that release of mercury from dental clinics to the environment can be extensively reduced by several means including use of amalgam separators, traps and vacuum filters, and proper handling, collection, and storage of Hg-containing waste [2][7][3]. The introduction and use of sealed capsules by all dentists in Tehran has also helped in reducing the release of mercury to the wastewater.

Table 8. Wastewater treatment plants in Tehran (Tehran Wastewater Cooperation, 2014)

Treatment Plant	Start Date	Population Coverage	Mean Volume (m ³ /hr)	Length of Plant (km)
Sahebgaraneh	1955	2E+3	12	3.5
Mahallati	1999	3E+4	200	17.75
Zargand	1987	1.2E+4	190	23
Geytariyeh	1986	1.2E+4	62.5	18.2
Ghods	1995	8.5E+4	1260	198
Shush	1882	4E+4	240	42
Ekbatan	1884	1E+5	625	29
Tehran South	First phase 2009	2.1E+5	9E+3	-
	Phase 2 to 4 2011			

There are eight operating wastewater treatment plants in Tehran among which one is out of order. In case that clinic wastewater is transformed to each of these plants, the system imposes extra loading rate leading to reconsideration of designing criteria.

In the case of no filtration and amalgam separator, high values of Mercury particles have been observed. In comparison to usage of filtration this value can be reduced by 90% [19]. Due to the lack of wastewater collecting tank and no use of amalgam separator, all of the pollution leads directly to wastewater collection system and cesspools, endangering soil and underground waters. On the other hand it can permeate through wastewater treatment plants. Besides, generated wastewater from radiology and radiography sectors categorized as hazardous wastewater and toxic as materials like silver and Potassium cyanide enters municipal wastewater or underground aquifers. This wastewater contains great threat to environment and should be collected and delivered to corresponding organizations like Atomic Energy Organization. The followings are some of the reasons that authorities in Atomic Energy Organization do not engage enough with radiology wastewater:

- Short half life time (3 to 20 days).
- The low rate of generated wastewater in long period of time.
- Lack of sufficient space in atomic energy organization.
- Lack of specific operations on this type of wastewater.

As documented in the literature, the occurrence of metals and other contaminants in the environment (e.g. wastewater effluents) is undesirable and thus their presence has been regulated. Generally, the presence of some metals above certain concentrations in wastewater can be toxic to microorganisms used in wastewater treatment plants. The effect of metals on inhibition of microbial growth is dependent on several factors such as metal concentration, pH, biomass concentration, and presence of other metals [9, 15]. As an example, heavy metal ions like As³⁺ at levels of 0.05 mg L⁻¹, Hg²⁺ at 0.2 mg L⁻¹, Cd²⁺, Cr³⁺ and Cu²⁺ at 0.5 mg L⁻¹, and Pb²⁺ and Zn²⁺ at 1 mg L⁻¹ were reported by [22]. The scrap amalgam and amalgam filling in the removed teeth along with the amalgam lost to the wastewater stream during the dental practices require a strict and controlled program. Due to the absence of silver recycling companies or silver recovery units in Iran, X-ray fixer solution was disposed in the drain. To achieve the best management of dental wastewater, minimization, segregation, reuse and recycling program should be implemented as much as possible. Wastewater reduction must be carried out using less hazardous and toxic materials with a smaller amount of

packaging. For instance, installation of amalgam traps and application of small size capsules can minimize amalgam waste.

4 CONCLUSION

Considering the national and international environmental guidelines, the wastewater discharged from the investigated clinics contains high and unacceptable levels of metals including mercury. This implies that such wastewater should not be discharged to the domestic sewer system without adequate pretreatment. Based on the geographical positions of treatment plants in Tehran it would be logical to transfer dentistry wastewater to Tehran South plant as wastewater collection system is under construction and phases 5 and 6 of the South plant are functioning. Obviously, the source of these metals in the wastewater of investigated clinics is the materials and tools used in dental operations. Amalgam is one of the most common materials used for dental restorations. In Iran both capsule and powder types are commonly used. The powder amalgam has great demand in the market as it is cheaper and also it is placed in larger containers. To prevent the release of heavy metals into the environment, the use of amalgam capsule is preferred. Pollution Prevention, Waste Management is the first solution. Therefore, it is recommended primarily for the prevention of heavy metals in sewage, convenient and practical amalgam alternatives such as gallium, ceramic, composite resins and polymers used. However, the application of these materials is so rare due to the lack of the sufficient advertisement and public awareness. The only long-term solution for the issues prompted by amalgam is to completely remove it from dentistry centers. For the startup considering the following items would be necessary:

- The use of alternative and non-metallic filler instead of mercury amalgam.
- Public awareness about the dangers of dental amalgam.
- Equip dental units with amalgam separator (ISO 11143) and prevent the discharge of wastewater in municipal sewage.

REFERENCES

- [1]. Al Kawas, S., Abu-Yousef, I., Kanan, S., El-Kishawi, M., Siddique, A., Abdo, N., Shraim, A., 2008. Analysis of mercury in wastewater of some dental clinics in United Arab Emirates. *J. Int. Environ. Appl. Sci.* 3, 21–28.
- [2]. Arenholt-Bindslev, D., Larsen, A.H., 1996. Mercury levels and discharge in waste water from dental clinics. *Water, Air, Soil Pollut.* 86, 93–99.
- [3]. Batchu, H., Rakowski, D., Fan, P.L., Meyer, D.M., 2006. Evaluating amalgam separators using an international standard. *J. Am. Dent. Assoc.* 137, 999–1005.
- [4]. Berzas Nevado, J.J., Garcia Bermejo, L.F., Rodriguez Martin-Doimeadios, R.C., 2003. Distribution of mercury in the aquatic environment at Almaden, Spain. *Environ. Pollut.* 122, 261–271.
- [5]. Community strategy concerning mercury. http://www.europa.eu.int/comm/environment/chemicals/mercury/pdf/com_2005_0020_en.pdf, updated January 28, 2005, accessed January 31, 2005.
- [6]. Desmet, F., Lemaitre, L., Vanpeteghem, A.P., Dhauwers, R., 1984. Recovery of mercury from dental amalgam waste. *Mater. Chem. Phys.* 11, 305–309.
- [7]. Drummond, J.L., Cailas, M.D., Croke, K., 2003a. Mercury generation potential from dental waste amalgam. *J. Dent.* 31, 493–501.
- [8]. Fan PL, Batchu H, Chou HN, Gasparac W, Sandrik J, Meyer DM. Laboratory evaluation of amalgam separators. *JADA* 2002; 133:577– 89.
- [9]. Gikas, P., 2008. Single and combined effects of nickel (Ni(II)) and cobalt (Co(II)) ions on activated sludge and on other aerobic microorganisms: a review. *J. Hazard. Mater.* 159, 187–203.
- [10]. Horsted-Bindslev, P., 2004. Amalgam toxicity – environmental and occupational hazards. *J. Dent.* 32, 359–365
- [11]. Hylander, L.D., Goodsite, M.E., 2006. Environmental costs of mercury pollution. *Sci. Total Environ.* 368, 352–370.
- [12]. Ismail, A.I., 2006. Neurotoxicity of mercury in dental amalgam. *J. Am. Med. Assoc.* 296, 1461–1462.
- [13]. Klemenc, F., Skreblin, M., Horvat, M., Stegnar, P., 1992. Mercury levels in dental surgeries and dental personnel in Slovenia. *Chemosphere* 24, 1731–1743.
- [14]. Kummerer, K., Wallenhorst, T., Kielbassa, A.M., 1997. Mercury emissions from dental chairs by disinfection. *Chemosphere* 35, 827–833.
- [15]. Li, H., Feng, Y., Zou, X., Luo, X., 2009. Study on microbial reduction of vanadium metallurgical waste water. *Hydrometallurgy* 99, 13–17.
- [16]. O'Brien WJ. *Dental materials and their selection*, second ed. Chicago, IL: Quintessence Publ Co; 1997. pp. 187–201.
- [17]. Stone, M.E., Cohen, M.E., Liang, L., Pang, P., 2003. Determination of methyl mercury in dental-unit wastewater. *Dent. Mater.* 19, 675–679.
- [18]. Vandeven, J.A., McGinnis, S.L., 2005. An assessment of mercury in the form of amalgam in dental wastewater in the United States. *Water, Air, Soil Pollut.* 164, 349–366.
- [19]. USEPA. National Primary Drinking Water Regulations: Public Notification Rule. Federal Register: June 21, 2000; Volume 65, Number 120. <http://www.epa.gov/EPA-WATER/2000/June/Day-21/w9534.htm> last updated Dec. 24, 2003; accessed March 23, 2005.
- [20]. USEPA. Protocol for the verification of mercury amalgam removal technologies. Ann Arbor, MI, USA7 NSF International; 2001.
- [21]. WHO, 1978. Environmental Health Criteria for Mercury 7-1, pp. 28–30.
- [22]. Zhou, S., Wei, C., Liao, C., Wu, H., 2008. Damage to DNA of effective microorganisms by heavy metals: impact on wastewater treatment. *J. Environ. Sci.* 20, 1514–1518.

Investigation of Degredability of Ibuprofen from Wastewater by Using Advanced Oxidation Process

Sevde Ustun Odabasi¹, Hanife Buyukgungor*

Abstract

Pharmaceutical in natural waters could be an environmental problem because of their potential toxicology risk on living organisms. Conventional wastewater treatment plants are not enough to remove pharmaceutical therefore advanced oxidation process have become an emerging solution. Ibuprofen (IBF), a non-steroidal anti-inflammatory drug (NSAID), is a most widely used medicine in almost every part of world. In present study, under laboratory conditions, coagulation followed by advance oxidation, using H₂O₂ and FeSO₄ (fenton process) is used to degrade the concentrations of ibuprofen from water were conducted. Fenton process is known to be most effective and common methods for the treatment of such wastewaters. In the present study H₂O₂ was used with FeSO₄ for the treatment ibuprofen and effects of H₂O₂, FeSO₄ concentrations COD and TOC removals. Experiments with optimal concentrations of H₂O₂ and FeSO₄ were carried out by chancing pH, temperature, stirring and residence time of solution (2-6), room temperature, (10,20,30 min) and (30,60,90 min) respectively. Concentration of FeSO₄ and H₂O₂ were selected as (30,75,150 mg/L). After processing, 150 ml of samples taken out from the upper layers of sample COD and TOC tests were conducted.

Keywords: *Ibuprofen, Pharmaceuticals, Fenton Process, Water, Wastewater*

1. INTRODUCTION

It has been observed the pharmaceuticals residues on ground and surface water, wastewater where they have been found at very low concentrations like ng/L to mg/L [1]. Ibuprofen (IBF) is a non-steroidal anti-inflammatory drug (NSAID) [2], consuming often both for human and veterinary practices. Ibuprofen leaves the body in the shape of metabolized and non-metabolized after excretion [3]. Therefore the form links up with other substances on water, the regenerated form may cause hazard for aquatic environments. As a result of common use of IBF, there exists very high concentration of IBF in wastewater. To say more clearly, after using IBF by patients, the disused parts are removed out of body by urine [4]. In this way, the residue of IBF goes through canalization and arrives treatment plant. It is not only way to survive of the contamination but also the other way to survive is cumulating in sediments. The water from treatment plant and sediment can be used for agriculture which has access to reach soil and ground water. Conventional treatment plants are not advanced to refine the water, classic physical-chemical techniques and conventional microbiological techniques can not effectively treat micropollutants. To purify them, Advanced Oxidation Process (AOP) is usually used. Many advanced treatment technologies have been used in removal of micropollutants. These methods include membrane technologies, ozonation, ultraviolet, ultrasound, hydrogen peroxide-ultraviolet, and fenton [5]. Fenton Processes, a branch of AOP, are seen as a good process for micropollutant removal, and also it is easy to apply, works quickly. With these qualifications, fenton is most commonly used process for IBF removal. In this study the effectiveness of IBF degradation in drinking water uses fenton process.

2. MATERIAL & METHODS

In the present study, under laboratory conditions, coagulation and advance oxidation, using H₂O₂ and FeSO₄ (Fenton process) is used to degrade the concentrations of ibuprofen from water were conducted. We have taken 25 mg/l ibuprofen synthetic solution. Biodegradability of the treated solutions (COD) and test with background constituents in

¹ sevde.ustun@omu.edu.tr, hbuyukg@omu.edu.tr

the water matrix, like TOC will also observed. In the end of the experiments, to measure the efficiency of Fenton process, optimum pH, FeSO_4 , H_2O_2 , stirring time, residence time and temperature will be measured. Before starting our experiments we checked initial values of COD, TOC and amount of ibuprofen in untreated samples. Later, we selected different parameters like, pH values (2-6), FeSO_4 and H_2O_2 concentration (30-75-150 mg/l), stirring time (10, 20, 30 minutes), residence time (30, 60, 90 minutes) and room temperature that will be provided to our sample and optimal (high) values will be selected. After processing, 150 ml of samples was taken out from the upper layers of samples and COD and TOC tests were conducted.

A solution of ibuprofen, obtained market was prepared in tap water to carry out advanced oxidation with fenton process. In the experiments, BROFEN namely tablet was used to obtain 25 mg/L ibuprofen content. For the preparation of sample, tablet containing 25 mg ibuprofen tablet was first finely grinded to powdered form and then mixed with tap water in 1 liter flask to prepare 25 mg drug/liter solution.

We used in fenton process 35% pure grade H_2O_2 hydrogen peroxide (Merck), $\text{FeSO}_4 \cdot 7\text{H}_2\text{O}$ iron sulphate (Sigma Aldrich), 98% pure grade H_2SO_4 sulfuric acid (Merck), NaOH sodium hydroxide (Merck). We used in COD process potassium dicromate K_2CrO_4 (Merck), Iron ammonium sulphate (Carlo Erba) 99% pure grade 1.10-phenanthroline and monohydrate (Sigma Aldrich), mercury sulphate (sigma aldrich), silver sulphate (sigma aldrich), thermo reactor (spectroquant TR 320). We used in TOC analyze Apollo 9000 combustion TOC analyzer.

The purpose of this study is to analyze the optimum degradation of ibuprofen by using different parameters like pH, temperature, stirring time, waiting time, amount of Iron sulphate and hydrogen peroxide.



Figure 1. Fenton Process System

3. RESULTS AND DISCUSSION

In this context, first of all experiment with different pH like 2,3,4 and 6 was performed with concentrations: 75mg/l; FeSO_4 , 75ml/l; H_2O_2 , stirring time;20 minutes, waiting time 60 minutes. After measuring COD and TOC optimum pH was observed to be in between 3 and 4. Because the value was more closer to 3 and after consulting literature further experiments were decided to carry out by taking 3.5 pH as optimum [6]. Values and results of TOC and COD can be cross checked from table 1 and figure 2.

Table 1. IBF removal with fenton process. H_2O_2 :75 mg/L, Fe^{2+} : 75 mg/L, stirring time:20 min, waiting time:60 min

pH value	Final concentration (COD) (mg/L)	Efficiency (COD removal (%))	Final concentration (TOC) (mg/L)	Efficiency (TOC)
2	262	7,74	66,57	14,95
3	102	64,08	53,22	32,01
4	115	59,50	59,53	23,95
6	230	19,01	71,88	8,17

(Initial pH:6,85, Initial COD: 284 mg/L, Initial TOC concentration: 78,28 mg/L C)

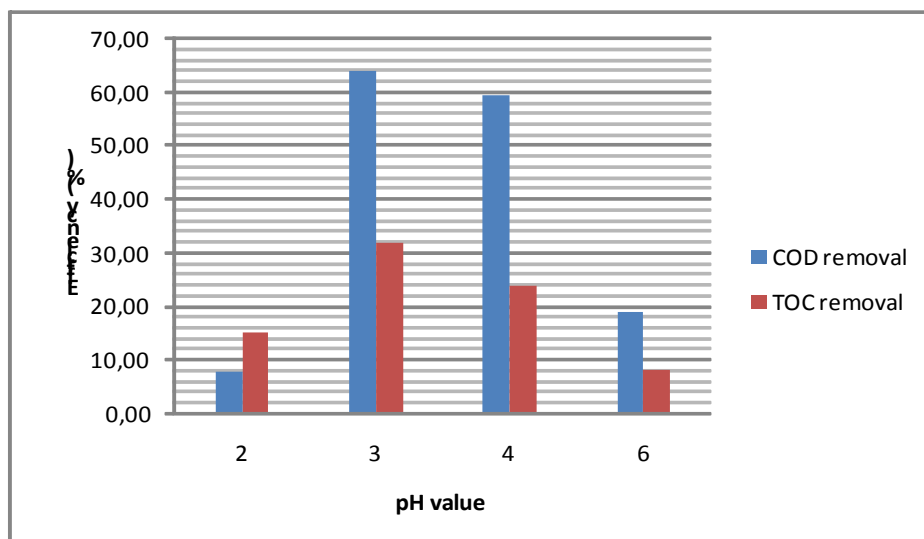

Figure 2. IBF removal with fenton process. Efficiency with COD and TOC.

In the second step optimum concentration of FeSO_4 required for the degradation of drug was analyzed. For this purpose with optimum pH of <3.5, 75 mg/L; H_2O_2 , stirring time; 20 minute, waiting time 60 minute, different concentrations of FeSO_4 like, 30-75-150 mg/L were tried to select optimum amount to carry out further series of steps. As per the observed results of COD and TOC best value of FeSO_4 was 150 mg/L. Values and results of TOC and COD can be seen in table 2 and figure 3.

Table 2. IBF removal with fenton process. $\text{Ph} < 3,5$, H_2O_2 : 75 mg/L, stirring time: 20 min, waiting time: 60 min

Fe^{+2} Concentration (mg/L)	Final concentration (COD) (mg/L)	Efficiency (COD removal) (%)	Final concentration (TOC) (mg/L)	Efficiency (TOC)
30	59,43	79,07	50,30	35,74
75	58,60	79,36	49,98	36,15
150	19,20	93,23	49,68	36,53

(Initial pH: 6,85, Initial COD: 284 mg/L, Initial TOC concentration: 78,28 mg/L C)

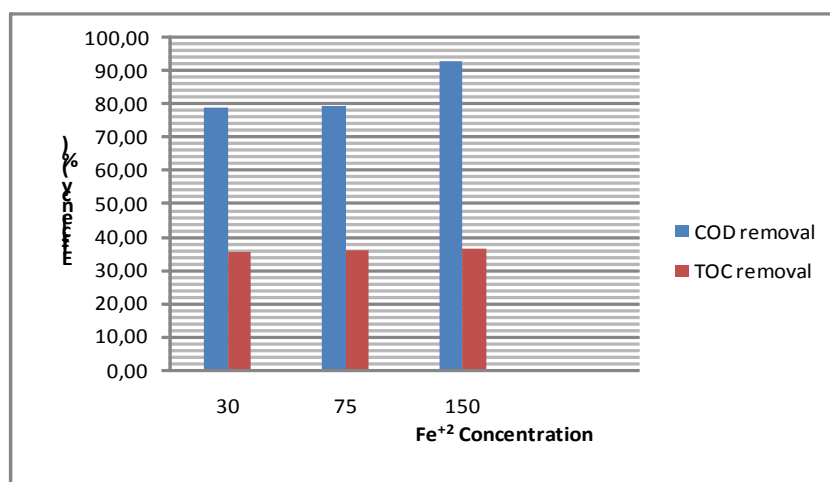

Figure 3. IBF removal with fenton process. Efficiency with COD and TOC

The purpose of third step was selection of optimum value of H₂O₂. In this step different concentrations of H₂O₂ like 30-75-150 mg/L were tried with optimum pH<3.5, optimum value of FeSO₄ 150 mg/L along with stirring time; 20 minute, waiting time 60 minute. According to the observed values of COD and TOC optimum value of H₂O₂ was selected as 150 mg/L. Published literature has show that degradation of drugs increases with the increase amount of H₂O₂, hence increased amount of H₂O₂ means good degradation [7]. After these results we assumed that our research is on right track. Observed TOC and COD values and results are shown in table 3 and graph 4.

Table 3. IBF removal with fenton process. pH<3,5, Fe²⁺: 150 mg/L, stirring time:20 min, waiting time:60 min

H ₂ O ₂ Concentration (mg/L)	Final concentration (COD) (mg/L)	Efficiency (COD removal) (%)	Final concentration (TOC) (mg/L)	Efficiency (TOC)
30	48	83,09	53,04	32,20
75	32	88,73	41,18	47,39
150	16	94,36	37,70	51,83

(Initial ph:6,85, Initial COD: 284 mg/L, Initial TOC concentration: 78,28 mg/L C)

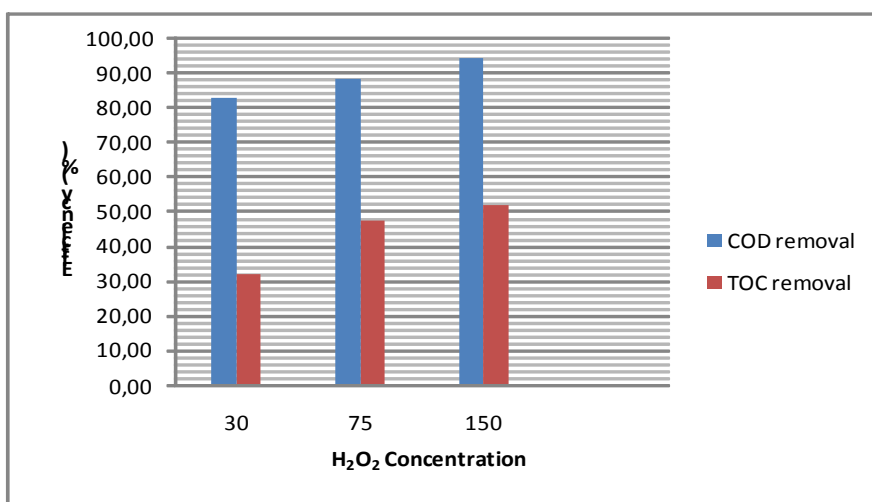

Figure 4. IBF removal with fenton process. Efficiency with COD and TOC.

In the fourth step the optimum stirring time was figured out by applying different stirring times of 20-30-60 minutes to the solution under optimized parameters: pH<3.5, 150 mg/L; FeSO₄, 150 mg/L; H₂O₂, waiting time 60 minute. COD and TOC showed that 10 minute is the best optimum stirring time. Values of TOC and COD are showed in table 4 and final results are showed in figure 5.

Table 4. IBF removal with fenton process. pH< 3,5, H₂O₂:150 mg/L, Fe²⁺: 150 mg/L, waiting time:60 min

Stirring time (min)	Final concentration (COD) (mg/L)	Efficiency (COD removal) (%)	Final concentration (TOC) (mg/L)	Efficiency (TOC)
10	6,4	97,74	35,69	54,40
20	16	94,36	37,70	51,83
30	20	92,95	44,40	43,28

(Initial ph:6,85, Initial COD: 284 mg/L, Initial TOC concentration: 78,28 mg/L C)

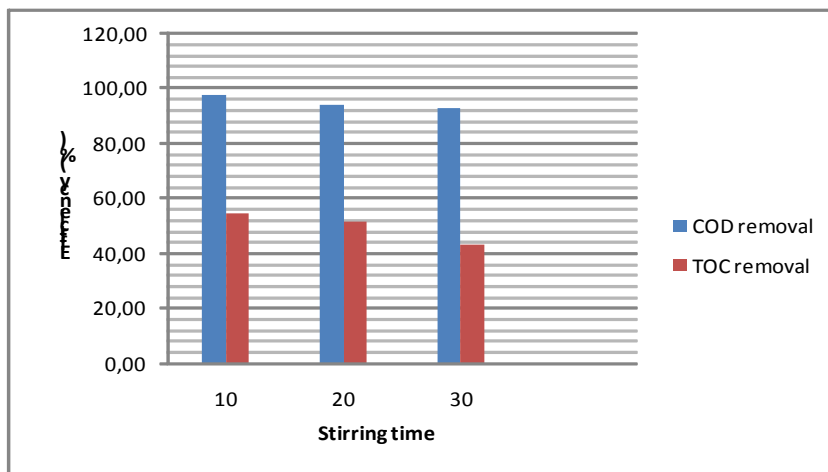

Figure 5. IBF removal with fenton process. Efficiency with COD and TOC.

Fifth step was to optimize the waiting time, for this purpose time directions 30-60-90 minutes were provided to solution with other already optimized parameters as described above. Final optimized waiting time was cross checked by performing COD and TOC tests and it was finalized that waiting time of 90 minute was best optimum time. Observed TOC and COD values and results are shown in table 5 and graph 6.

Table 5. IBF removal with fenton process. H_2O_2 : 150 mg/L, Fe^{+2} : 150 mg/L, stirring time: 10 min

Settling time (min)	Final concentration (COD) (mg/L)	Efficiency (COD removal (%))	Final concentration (TOC) (mg/L)	Efficiency (TOC)
30	7,0	97,53	38,18	51,22
60	6,4	97,74	35,69	54,40
90	6,1	97,85	34,98	55,31

(Initial ph:6,85, Initial COD: 284 mg/L, Initial TOC concentration: 78,28 mg/L C)

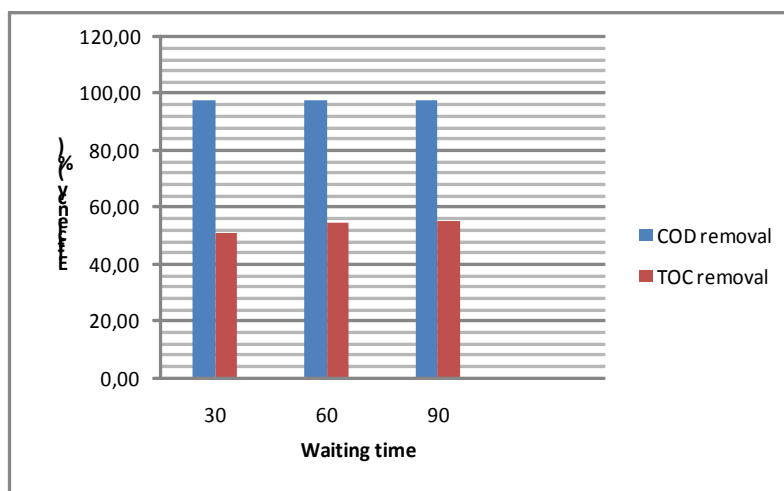

Figure 6. IBF removal with fenton process. Efficiency with COD and TOC.

4. CONCLUSION

All the results for investigated tap water sample containing drug (ibuprofen) are precisely described below: pH<3.5, $FeSO_4$; 150 mg/L, H_2O_2 ; 150 mg/L, stirring time; 10 minute, waiting time; 90 minute were optimized. According to these results highest removal efficiencies for COD and TOC are 97,85 and 55,31 % respectively. Observed values of

pH and H₂O₂ are in agreement with the published literature. With this research optimum figures for the degradation of ibuprofen in the tap water by fenton process were questioned. According to the results of the analysis, it can be decline that the best solution for the removal of pharmaceutical pollution from wastewater or freshwater resources is fenton process which is compared with others.

REFERENCES

- [1] M. Markovic, M. Jovic, D. Stankovic, V. Kovacevic, G. Roglic, G. Gojgic-Cvijovic, D. Manojlovic, "Application of non-thermal plasma reactor and Fenton Reaction for Degredation of Ibuprofen", Science of Total Environment, vol:505, pp: 1148-1155, Nov. 2014.
- [2] M. Kwon, S. Kim, Y. Yoon, Y. Jung, T. Hwang, J. Lee, J. Kang, "Comparative evaluation of ibuprofen removal by UV/H₂O₂ and UV/S₂O₈ process for wastewater treatment", Chemical Engineering Journal, vol: 269, pp:379-390, February' 2015.
- [3] L. Lishman, S. A. Smyth, K. Sarafin' S. Kleywegt, J. Toito, T. Peart, B. Lee, M. Servas, M. Beland, P. Seto "Occurance and reductions of pharmaceuticals and personal care products and estrogens by municipal wastewater treatment plants in Ontorio, Canada", Science of the Total Environment, vol: 367, pp: 544-558, August, 2006.
- [4] K. Kummerer, " Drugs in the environment-. Emissions of drugs, diagonistic acids and disinfectants into wastewater by hospitals in relation to other siurces-a review", Chemosphere, vol: 45, pp: 957-969, November, 2001.
- [5] H. A. Hasan, S. R. S. Abdullah, A. W. N. Al-Attabi, D. A. H. Nash, N. A. Rahman, H. S. Tiah, " Removal of ibuprofen, ketoprofen, COD and Nitrogen Compounds from Pharmaceutical wastewater using aerobic suspension-sequencing bath reactor (ASSBR)", Seperation and Purification Technology, vol: 157, pp: 215-221, November, 2015.
- [6] G. Sonmez, "Removal of some pharmaceutical residues by advanced chemical oxidation process", Aksaray University, Science Enstitue, November, 2015.
- [7] Y.W. Kang, ve K.. Hwang, "Effect of reaction conditions on the oxidation efficiency in the Fenton process", Water Research, vol:10, pp:2786-2790, Jully, 2000.

BİOGRAPHY

Sevde USTUN ODABASI works as a research assistant at Ondokuz Mayıs University Environmental Engineering Department.

Ustun Odabasi received her BSc in Environmental Engineering in 2011 from Ondokuz Mayıs University, Samsun, Turkey, and her MSc in Environmental Engineering in 2013 from Ondokuz Mayıs University, Samsun, Turkey. Her master thesis subject was 'Life Cycle Assessment'. She is still PhD student on Investigation of Environmental Effects of Micropollutants and Its Removal in Frame of Sustainability at Ondokuz Mayıs University Environmental Engineering Department.

She may be contacted at sevde.ustun@omu.edu.tr or sevde.ustun@gmail.com.

Investigation Of Domestic Wastewater Discharge Performance Of Submarine Outfalls In Rize Province And Alternative Proposals

Ozge Koksall¹, Tolga Ayeril¹, Yuksel Ardalil¹

Abstract

Domestic wastewater discharges to marine environment by submarine outfall systems are the most commonly used method of wastewater disposal in coastal regions. The aim of this study is to investigate the performance of the submarine outfalls in Rize, Turkey. In order to analyze the negative effects of marine ecosystems, the submarine outfalls performance should be given to monitoring of all them. We investigated the dilution of domestic wastewater around Rize and measured sea water for water quality conditions such as pH, conductivity, oil-grease, BOI₅, AKM, KOI, kjieldahl nitrogen, total nitrogen, total phosphorus, total coliform, fecal coliform. The effects of pre-treatment to dilution were investigated by analyzing of the input sewerage wastewater. We have identified the different treatment scenarios it is important to evaluate the results of the study with discharge system. Design should not be overlooked in the sea outfall of the special features of the Black Sea have emerged requirements.

Keywords: *Submarine outfall, domestic wastewater discharge, marine pollution.*

1. INTRODUCTION

In addition to other seas and oceans of the Black Sea's secession from big polluting sources, especially land based in domestic, industrial and agricultural source pollutants, reducing the ecological sensitivity of the Black Sea is every day increases the burden of pollution. Symptoms of eutrophication are attracting attention especially in recent years [1]. Various sewage discharges into the Black Sea and reaching to the sea as a result of agricultural operations with nutrients resulting in eutrophication as a result of collapsing to the bottom of the sea, in addition to the organic matter of the organism is the cause of the disappearance [2].

To determine of performance of legislation for the Black Sea ecology and operated submarine outfall supported by determination of the impact of the requirement in the Black Sea. According to the Urban Wastewater Treatment Directive, the integrated basin management of the terrestrial origin of the effect to the sea of land based pollutants determination and measures to be carried out many projects [3]. In line with the Water Framework Directive, the design and operation of the submarine outfall, adapting legislation, taking into consideration the conditions of the Black Sea when designing, monitoring and modeling issues studies of large dilution is needed [4]. Turkey in Black Sea shores municipal and industrial pollution is one of the measures taken in order to prevent submarine outfall. Submarine outfall is dilution capacity of the sea in order to take advantage of a disposal method [5]. For many years, to the Black Sea disposal of land based pollutants on terrestrial origin method as applied to the determination of the effects of submarine outfall of Black Sea and terrestrial origin, putting the future of pollutants appropriate disposal has emerged the necessity [6].

2. MATERIALS AND METHODS

2.1 Study Area

Rize is involved in the eastern part of the Eastern Black Sea coastline, 40°-22' and 41°-28' east longitude and 40°-20' and 41°-20' amongst the northern parallel.

¹ *Ondokuz Mayıs University, Engineering Faculty, Department of Environmental Engineering, Samsun, 55139, Turkey.ozgekoksall8@gmail.com*

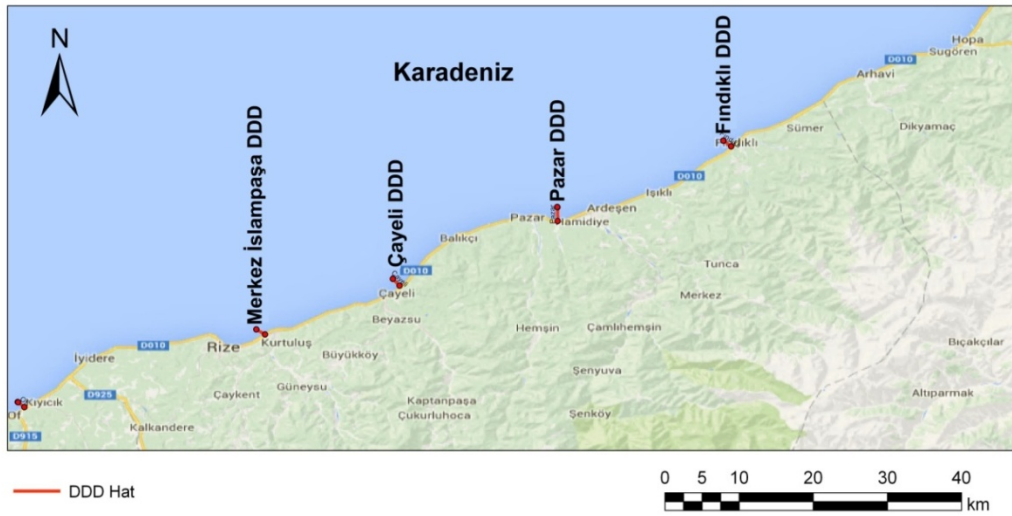

Figure 1. Rize-İslampaşa and Rize-Fındıklı submarine outfall lines [7].

Trabzon of the west, from the south to the east of Erzurum, Yusufeli, Arhavi and Artvin, İspir districts of Rize on the Black Sea from the north with surrounded by lakes area except 3.922 km². According to the population census data based on the address in 2014, it is 329.779. The part of 211.495 population the city center and 118. 284 people are living in towns and villages in the districts.

The Black Sea region designated in the spot for domestic and industrial submarine outfall applications inventory. Also available submarine outfall line entries are identified by examining the current situation of pre-treatment facilities, designated positive and negative aspects of the evaluations have been conducted.

Rize-İslampaşa submarine outfall average 277 l/s flow approximately 44 m submarine outfall line 1142 m was determined. 52 m long diffuser is available on line. In the project is 258 m steel pipe, 895 m HDPE pipe. Like other lines in the Black Sea existing lines except as embedded in the floor diffusers.

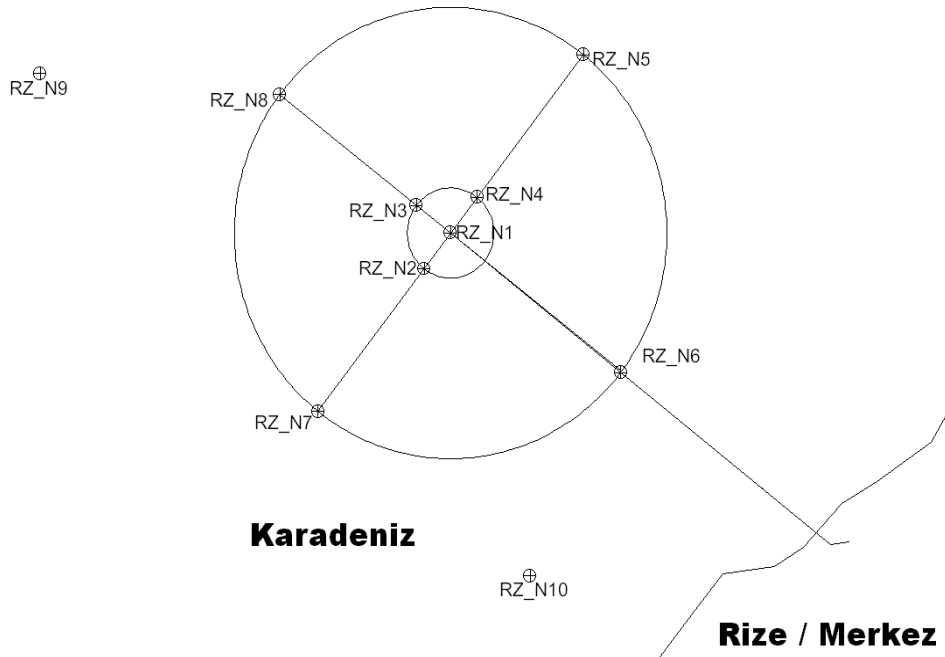

Figure 2. Rize / İslampaşa submarine outfall line sampling points [7].

System filled in 2016 economic life of physical treatment center it is planned the construction of the treatment plant at the point. Secondary treatment will be suitable for the post submarine outfall area. During periods of heavy rainfall flow rate is expressed as the increase occurred and bleeds.

Rize-Fındıklı submarine outfall line in the region of the other facilities such as fully embedded design line in terms reliability has appropriated. The total length is 1100 m of the line. Only 30 m long diffuser is on the ground. The diffuser depth is -44 m.

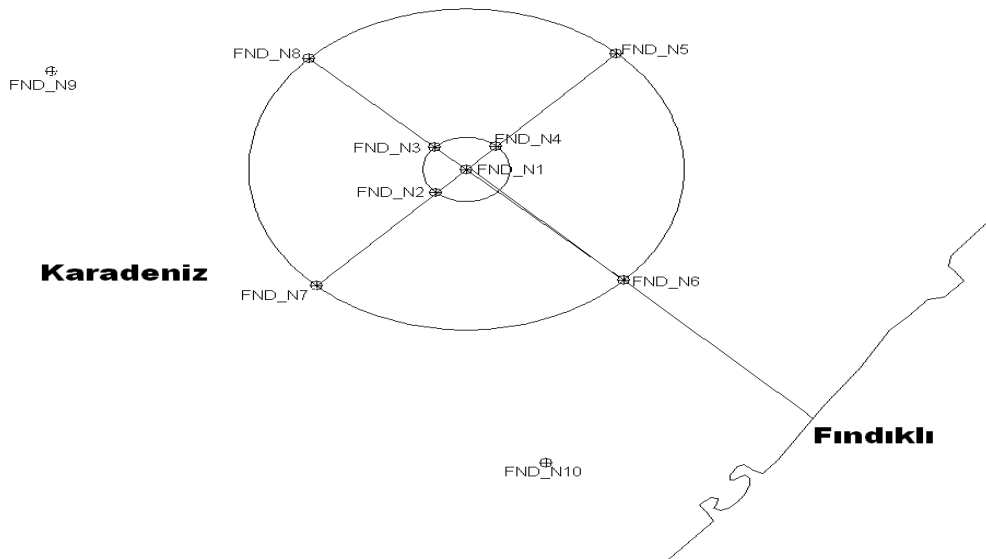

Figure 3. Rize / Fındıklı submarine outfall line sampling points [7].

Existing land structures are present and operational. Rain water drainage system to receive the rainy periods the second pump is activated. The outfall line is active and running. Sewage system should be revised and the rain water entry.

3. RESULTS AND DISCUSSION

Rize-Fındıklı system entrance in the summer, AKM (352 mg/L), oil-grease (95 mg/L) and MBAS (12.72 mg/L) values exceeds the specified limit values at the WPCR Table 22.

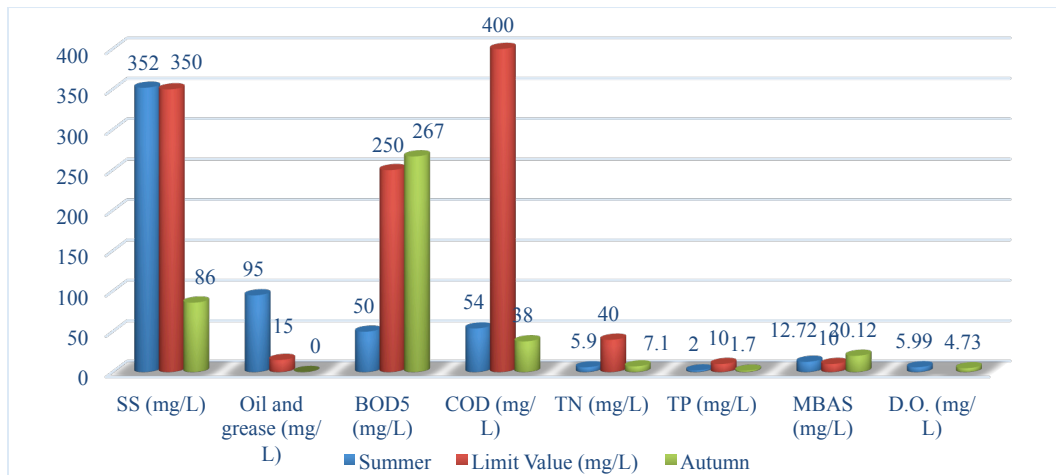

Figure 4. July-September 2015 period Rize-Fındıklı values measured in domestic wastewater sampling station

In the summer, Rize-İslampaşa submarine outfall system also at the entrance to the AKM (532 mg/L), oil-grease (253 mg/L), KOI (496 mg/L) and total nitrogen (52 mg/L) and MBAS (39.05 mg/L) values higher than the specified limit value at the WPCR Table 22.

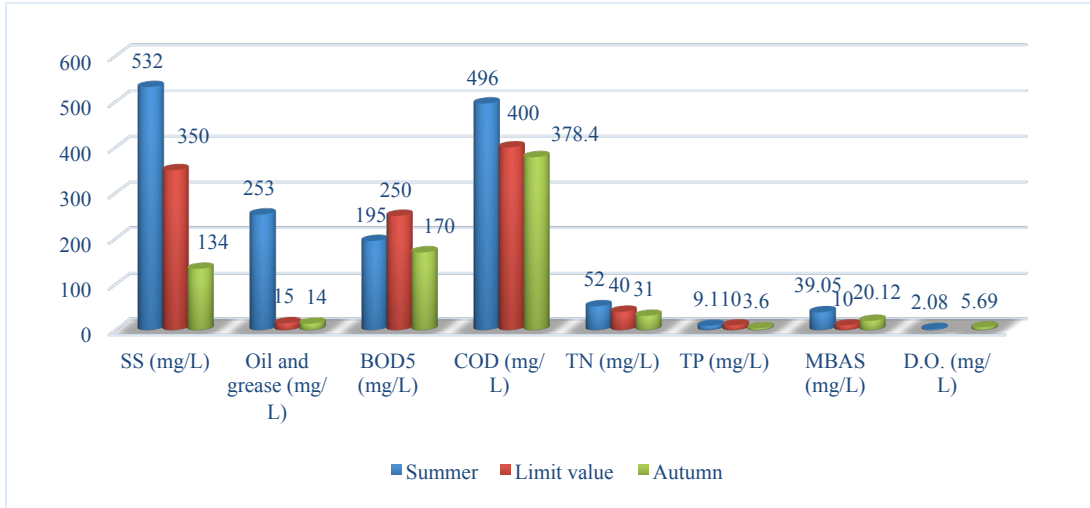

Figure 5. July-September 2015 period Rize-İslampaşa values measured in domestic wastewater sampling station

In the autumn, Rize- Fındıklı submarine outfall system entrance BOİ5 (267 mg/L) and MBAS (20.12 mg/L) values, Rize-İslampaşa submarine outfall system also at the entrance MBAS (20.12 mg/L) value exceeds the specified limit values at the WPCR Table 22.

3.1 CTD Evaluation

Rize-İslampaşa submarine outfall region, surface water temperature values ranged from 23.5°C to 25.0°C. There has not been a significant change in the surface water temperature. 15.31 m-25.7 m depth temperature at all points except for the N10 point decreased about 2.6°C-7.5°C. At this point the temperature stratification is concerned.

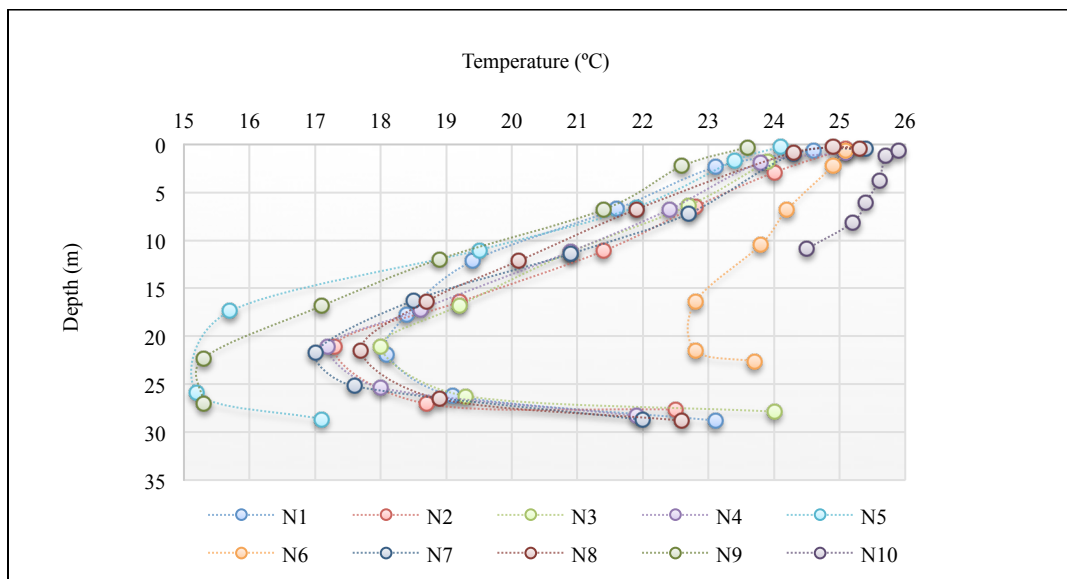

Figure 6. During the period of summer Rize-İslampaşa sampling station depth-temperature

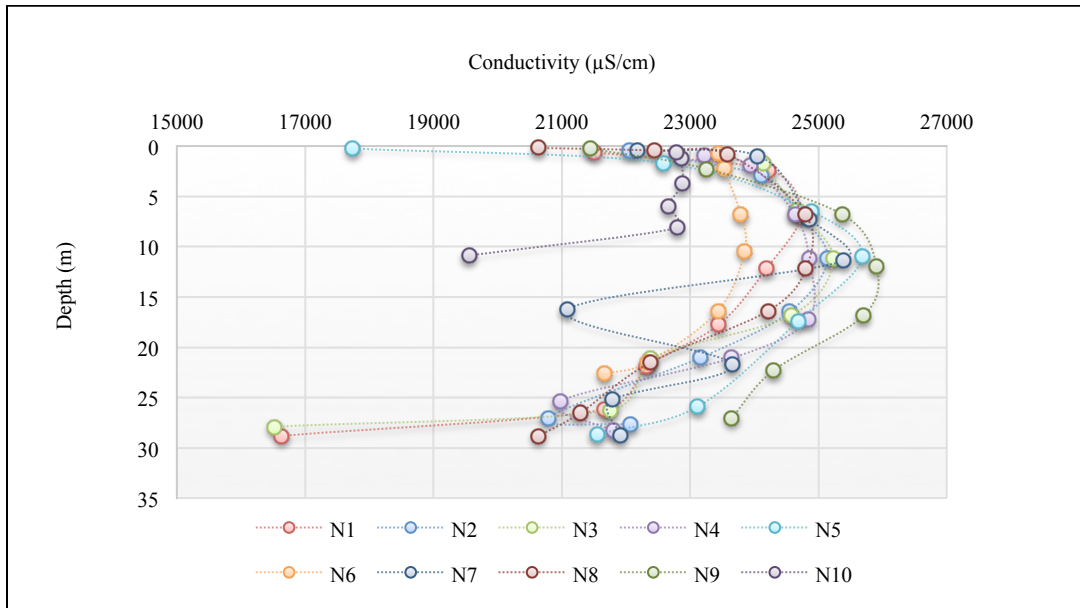

Figure 7. During the period of summer Rize-Islampaşa sampling station depth-conductivity

The surface temperature decrease at 10 selected points was determined that the bottom is correct. The surface diffuser above N1 24.1 °C and 22.1 °C was determined to be in 26-27 meters. The bottom surface salinity 12.7 psu-11.46 psu is determined that reduction. Electrical conductivity values which very largely parallel changes in temperature and the surface showed that the change in the value of 0.02 bottoms towards observed that reduction.

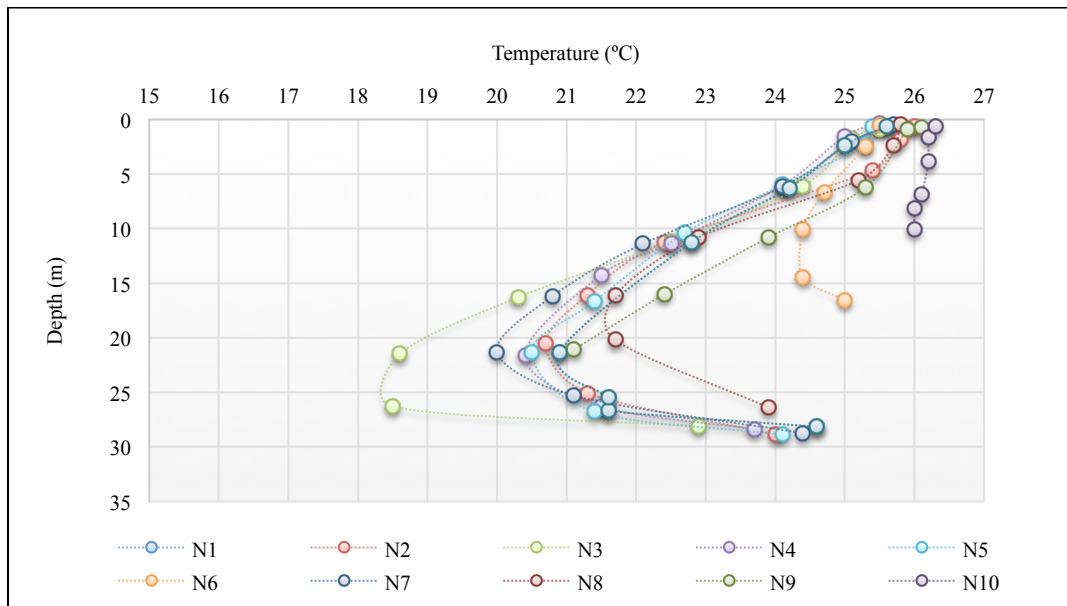

Figure 8. During the period of summer Rize-Fındıklı sampling station depth-temperature

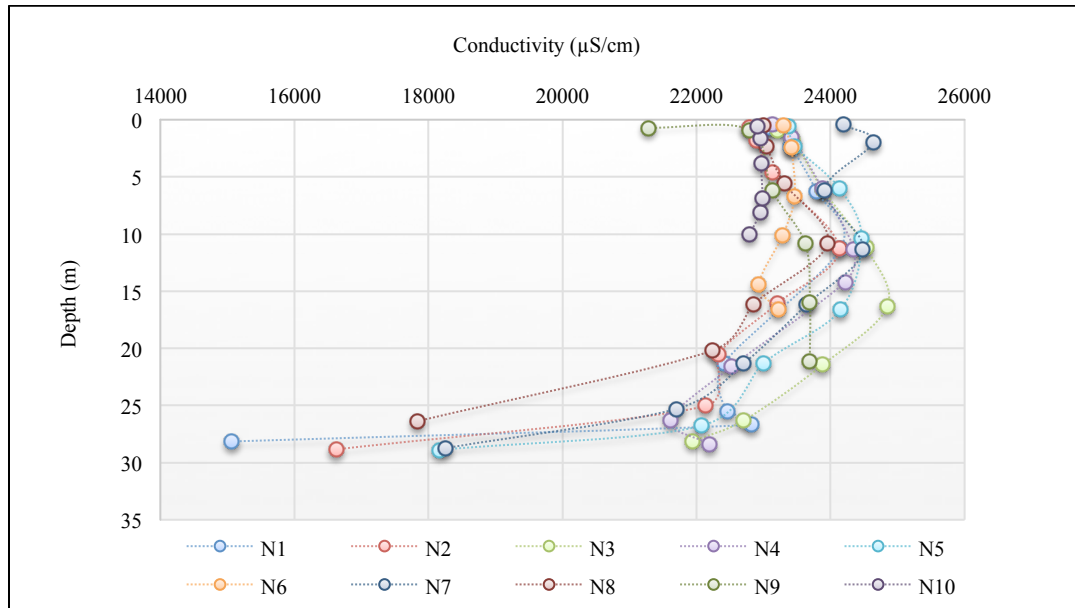

Figure 9. During the period of summer Rize-Fındıklı sampling station depth-conductivity

Rize-Fındıklı submarine outfall region, surface water temperature values are between 24.3 °C – 24.9 °C and surface water has not been a significant change. N1, N2, N3, N4, N5, N7, N8 and N9 from the 21.75 m-29.05 m depth decreased temperature around 2.6 °C-3.8 °C. The temperature stratification is concerned at this point. Electrical conductivity values are very largely parallel changes to temperature and 0.02 S/cm decrease in value is changed from the surface to the bottom.

4. CONCLUSION

Submarine outfall system entrance in the summer, AKM, oil-gress, KOI and total nitrogen and MBAS values in the autumn MBAS value WPCR Table 22 from values higher than the limit specified. Rize-Islampasa submarine outfall system before pre-treatment systems AKM, KOI, BOI, oil-gress etc. might resolve capacity parameters have not been designed. Therefore the values are high. The high value of the sewage system and wastewater from AKM line rain water and sewage are transported by materials coming into the feed system can be explained as the surface cover. KOI and oil-gress such as highly, especially the auto body shop, car wash etc. of standards from places without logging in first into the system of waste oil from the homes and so it can be explained. Testing detergents the use of wastewater in an extreme way nowadays surfactants increases too. Therefore, the surfactant in the wastewater is increased high.

Black Sea pollution is important in the outfall of pollutants from industrial and residential monitoring and determination of the impact on the marine ecosystem of this pollutant. Thus the Black Sea pollution prevention measures in order to know what's going on and these measures must be implemented easily where we put out first. Coastal regions the most commonly used method of wastewater disposal submarine outfall systems should be judged as a whole. The Eastern Black Sea region of the system a lot of submarine outfall system must be reviewed and in particular the effects of submarine outfall system pass in front of pollution. Submarine outfall system design in the marine environment in the intensity values that take into account the depth of the T_{90} trapping seasons can be observed in the stratification of wastewater outfall regulations to be made.

This study is supported by the Turkish Ministry of the Environment.

REFERENCES

- [1] [1] Blatov A. S., Bulgakov N. P., Ivanov V. A., Koserev A. N., Tuzhilkin V. S., 1984. Variability of Hydrophysical Fields in the Black Sea. Hydrometeoizdat Leningrad, 240.
- [2] [2] Orhan Y., Kömürcü, S., 2009. Polycyclic Aromatic Hydrocarbons and Quality Characterization of Water and Mussels from Yeşilırmak River and Estuary-Central Black Sea, *Ozean Journal of Applied Sciences*, 2, 217-228.
- [3] [3] Salas, H.J., 2000. Submarine Outfalls General Overview, Basic Design Concepts and Data Requirements for Latin America and The Caribbean, Pan American Center for Sanitary Engineering and Environmental Sciences, OPS/CEPIS/PUB/ 00.58, 1-14.
- [4] [4] Stull J. K., Haydock C. I., Montagne D. E., 1986. Estuarine, Effects of *Listriolobus pelodes* (Echiura) on Coastal Shelf Benthic Communities and Sediments Modified by A Major California Wastewater Discharge, *Coastal and Shelf Science*, 22, 1-17.
- [5] [5] Zaitsev Y., Mamaev V., 1997. Marine Biological Diversity in the Black Sea: A study of Change and Decline. GEF Black Sea Environmental Program me, United Nations Publications, 208.
- [6] [6] Mendonça A., Losada M. A., Solari S., Neves M. G., Reis M. T., Incorporating a Risk Assessment Procedure into Submarine Outfall Projects and Application to Portuguese Case Studies, 2012.
- [7] [7] T.C. Ministry of Environment and Urban Development, The Department of Marine and Coastal Management, Determination of Deep Sea Outfall Project Design Criteria Final Report, Ondokuz Mayıs University, Project manager Prof. Dr. Yüksel Ardali, 2015.

Biography

Özge Köksal was born in Artvin, Turkey in 1990. She obtained a bachelor's degree from Ondokuz Mayıs University Environmental Engineering Department. In 2016 June, she completed master's degree in Ondokuz Mayıs University.

Deep Sea Outfall of Natural Gas Fired Combined Cycle Power Plant Cooling Water Application and Modeling

Tolga Ayeri¹, Yüksel Ardali¹

Abstract

Combined Cycle Power Plants are in wide demand throughout the world, because they are characterized by short construction times, low investment costs, high operating efficiencies and low exhaust emissions. This type of power plants can reach fuel to electricity conversion efficiencies of 60%, at the same time it has minimal environmental impacts. The most important reason for this is the use of natural gas, which is a very clean fuel containing little or no sulfur, particulate matter and other unwanted ingredients.

This study was investigated the effect of cooling water from natural gas combined power plant to Black Sea region of Turkey. The parameters, which affect the marine ecosystem, were determined and in addition temperature, suspended solid, COD values were measured. Modelling of these measured values was performed throughout discharge line with the CORMIX-2 software developed by EPA (Environmental Protection Agency) as environmentally purpose.

Keywords: Natural gas, power plant, deep sea outfall, model

1. INTRODUCTION

Energy is what drives our lives. There is an ongoing global energy challenge caused by increasing energy demand, heavy dependence on oil and other fossil fuels which leads to air, water and land pollution. Large carbon emissions lead to global warming, climate instability and raises health concerns over pollution. Depletion of the fossil resources that are not uniformly distributed globally force the humanity to use the available precious energy resources as efficiently as possible [1].

Electricity power generation industry being the most important energy sector in many countries faces real problems; the continuous increase in fuel prices, exploding growth in energy demand, the recent strict environmental regulations and the severe competition after the liberalization of the energy market. As a result, power generation authorities seek performance improvements of the power plants. Operating more efficiently is important for the power plants to be able to compete in the deregulated energy market [2].

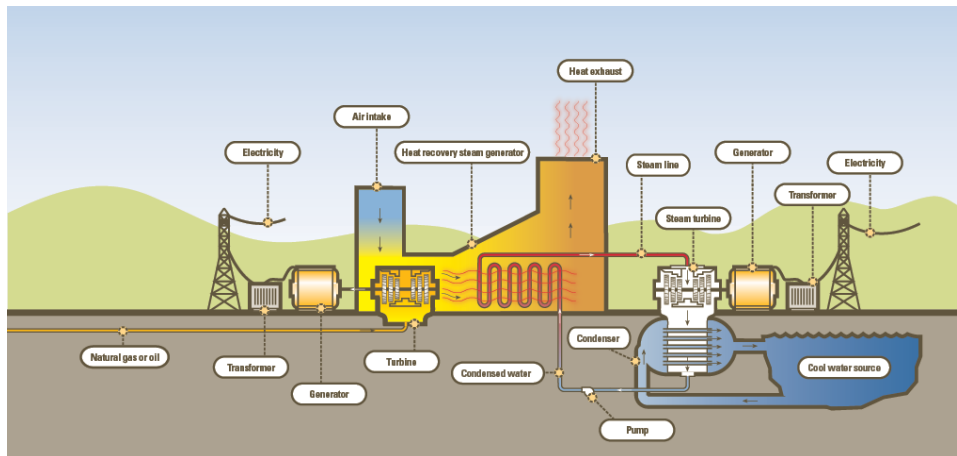

Figure 1. Combined Cycle Power Plants

¹ Ondokuz Mayıs University, Engineering Faculty, Department of Environmental Engineering, Samsun, 55139, Turkey. tolga.ayeri@omu.edu.tr

Gas turbine performance has been enhanced considerably in recent years due to the rapid development of component design and material technologies. Many applied power generation systems based on the gas turbine have been proposed, and several systems have already been applied in real settings. The gas/steam combined cycle plant, for instance, has already emerged as a standard technology for base load power generation [3].

Combined Cycle Power Plants utilize both gas turbines and steam turbines to generate electricity. In a combined cycle power plant, the gas turbine is coupled to a generator to allow it to produce electricity even it runs solo without a steam turbine. As the exhaust stream of the gas turbine has high energy, the gas turbine exhaust is connected to a heat recovery steam generator (HRSG) where steam is produced from the waste heat in the exhaust gas. The generated steam is used to turn the steam turbine that produces more electricity in addition to the simple gas turbine cycle. The steam turbine is connected to a condenser where the excess heat is rejected to the environment. This equipment's are the main components of a combined cycle power plant. These are also the components which determine and dominate the performance of a power plant. Apart from these main components, there are many auxiliary systems such as cooling systems, lubrication systems, pumps etc. in a combined cycle power plant [4].

2. MATERIALS AND METHODS

2.2 Study Area

The Black Sea, with its world's largest anoxic basin, is situated between the folded Alpine belts of the Caucasus and Crimea Mountains to the north and northeast, and the North Anatolian Mountains to the south, with an area of 432,000 km² and a volume of 534,000 km³. The Strait of Bosphorus connects the Black Sea to the Sea of Marmara to the south and southwest, which in turn, is connected to the Aegean Sea and the Mediterranean Sea through the Strait of Dardanelles. [5].



Figure 2. Locations of Black Sea

The Black Sea's catchment area which covers entirely or partially 22 countries in Europe and Asia Minor is more than 2 million km². Six of these countries are littoral (Bulgaria, Georgia, Romania, the Russian Federation, Turkey and Ukraine), while the other sixteen (Albania, Austria, Belarus, Bosnia-Herzegovina, Croatia, the Czech Republic, Germany, Hungary, Italy, Macedonia, Moldova, Poland, Slovakia, Slovenia, Switzerland and Yugoslavia) do not have shorelines with the Black Sea.

The length of the Black Sea shoreline is 4,340 km approximately. The Bulgarian coastline is 300 km long; the Georgian coastline 310 km; the Romanian coastline 225 km; the Russian coastline 475 km; the Turkish coastline 1,400 km and the Ukrainian coastline 1,628 km. The Black Sea shoreline is not ragged. There are several big or small peninsulas and bays through the shoreline, but no large islands are present. The largest peninsula is Crimea, located in the north. The largest bays are, Odessa Gulf, Yagorliksky Bay, Tendrovsky Bay, Karkinitsky Bay and Kalamitsky Bay in the north; Novorossiysk Bay in the east; Sinop Bay and Samsun Bay in the south; and bays of Igneada, Burgas and Varna in the west. The biggest island is Zmeiny (1.5 km²), located in front of the Danube delta [6].

2.3 Sampling and Analytical Methods

Water samples were taken in the summer and autumn 2016. Temperature ($^{\circ}\text{C}$), dissolved oxygen (DO), pH and electrical conductivity (EC) were measured on site using a field multi-probe (HQ40d Portable). Chemical oxygen demand (COD) and suspended solid were measured according to Standard Methods for the Examination of Water and Wastewater (APHA 1995). Water quality parameters were assessed accordingly Turkish Water Pollution Regulation (Table 1).

Table 1. Monitoring results of water quality parameters and the limit values (Turkish Water Pollution Control Regulation)

Parameters	Limit Value	Summer	Autumn
pH	6-9		
Temperature	35 $^{\circ}\text{C}$	19.3	24.8
Suspended Solid (mg/L)	350	2800	646
COD (mg/L)	400	990	79
Dissolved Oxygen (mg/L)	-	9.78	8.93
Electrical Conductivity ($\mu\text{S}/\text{cm}$)	-	26.6	29

2.4 Model Description

CORMIX is a USEPA-approved simulation and decision support system for environmental impact assessment of mixing zones resulting from point source discharges. The methodology contains systems to model submerged single-port (CORMIX1) and multipoint diffusers (CORMIX2) as well as surface discharge sources (CORMIX3). Effluents considered may be conservative, non-conservative, heated, or they may contain suspended sediments. The advanced information system tools described herein provide documented water quality modeling, regulatory decision support, mixing zone visualization, and tools for outfall specification and design optimization [7].

3. RESULTS AND DISCUSSION

The surface water quality parameters were given in Table 1. The pH of the water samples was within the range of 6.5–9. Also temperature values less than 35 $^{\circ}\text{C}$ degrees. The highest values of chemical oxygen demand (COD) were observed in the summer with 990 mg/L (Fig 3). Suspended solid is much higher than limit values both summer and autumn (Fig 4).

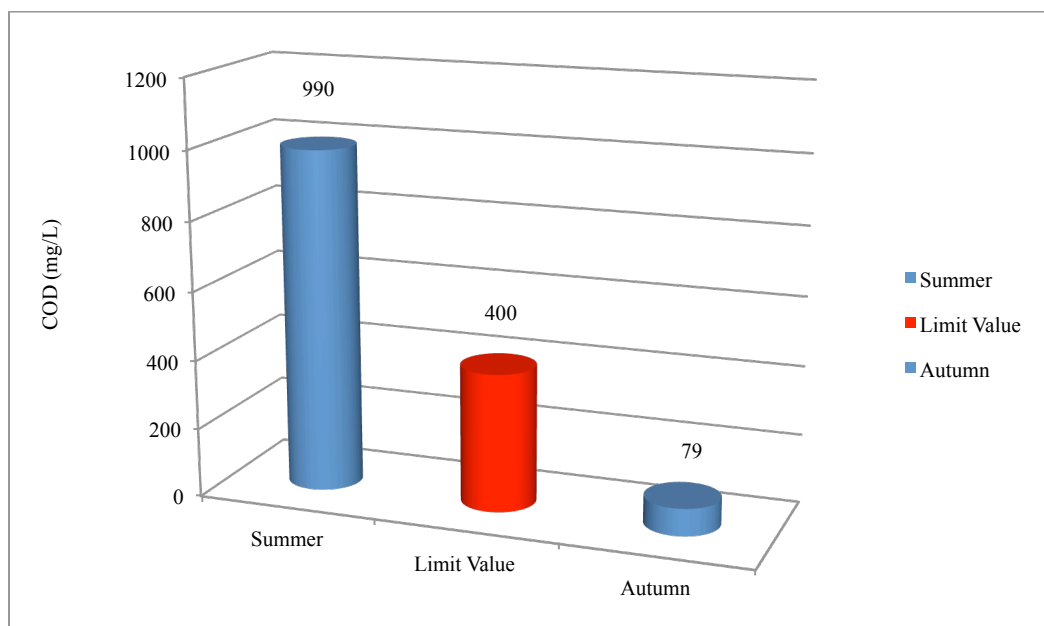

Figure 3. The comparison with the limit values for chemical oxygen demand of monitoring results

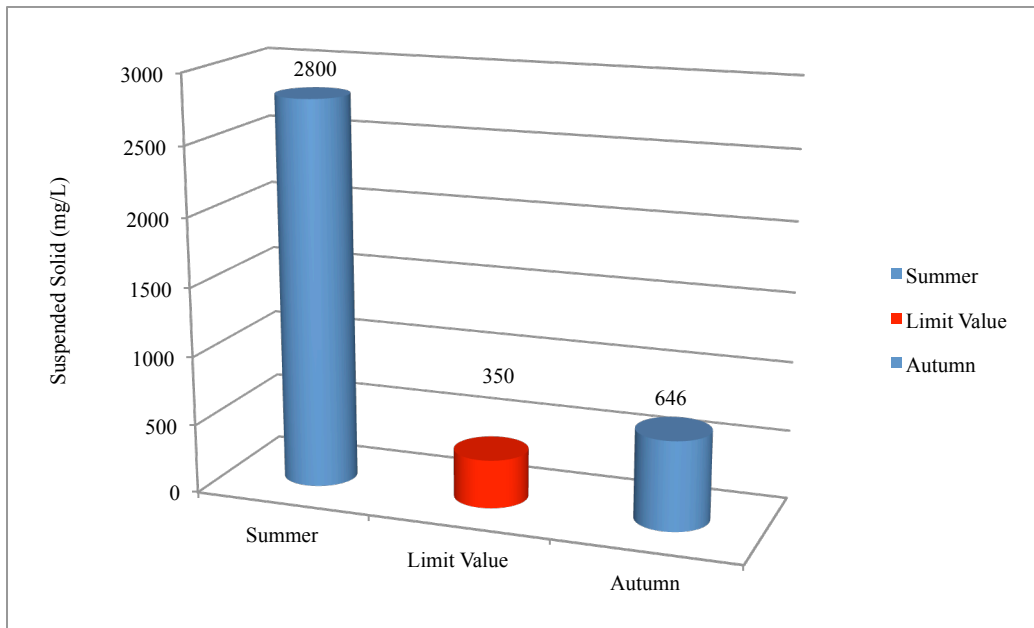

Figure 4. The comparison with the limit values for suspended solids of monitoring results

The electrical conductivity of the water samples was 26.6 and 29 ($\mu\text{S}/\text{cm}$), respectively. There were no boundary values of the electrical conductivity and dissolved oxygen according to Turkish Water Pollution Regulation. In addition, temperature values have to be one centigrade degree between ambient temperature and hot water discharge in accordance with Turkish Water Pollution Regulation. In order to determine the temperature difference was used Cormix2 model. Before mixing with the hot water into the sea, 9 °C degrees temperature difference was observed between ambient temperature and hot water discharge.

The green line in the Figure 5 shows that one degree of difference between ambient temperature and hot water discharge. It indicates that 1 °C temperature difference value is seen that at 10 m. Isometric view of hot water discharge was revealed using Cormix2 (Fig 6).Figure 6 were presented as the change in color code discharged wastewater temperature.

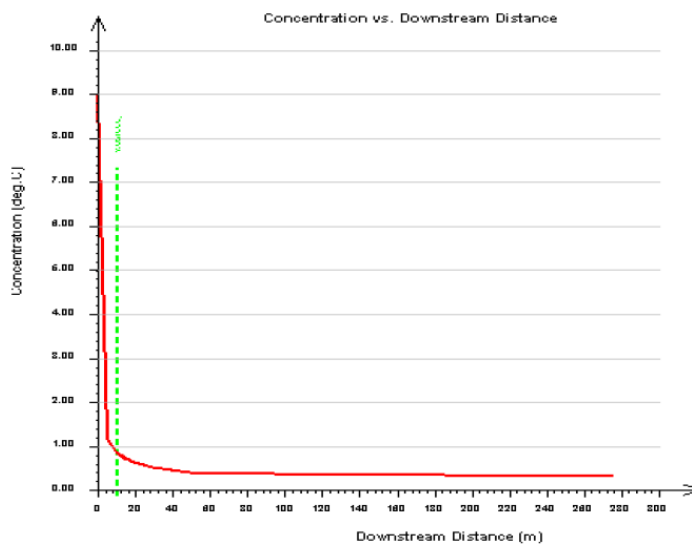

Figure 5. The difference graph between the ambient temperature and hot water discharge

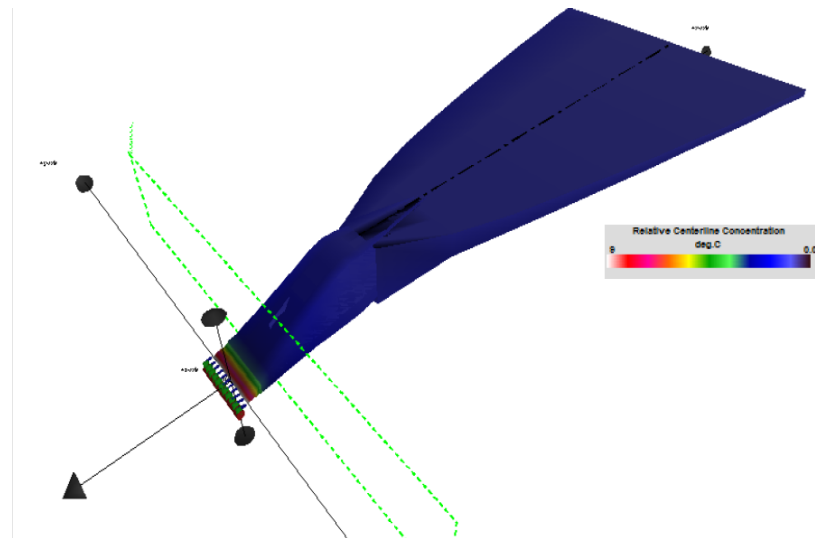

Figure 6. Isometric view of hot water discharge

4. CONCLUSION

In this study concentration of parameters such as pH, temperature, dissolved oxygen, suspended solid, chemical oxygen demand and electrical conductivity were measured in combined cycle power plant using natural gas in the Black Sea coast of Turkey. The CORMIX system is unique among mixing zone prediction methodologies in that it systematically accounts for boundary interaction, predicts density current behavior after boundary interaction, and provides rule-verified mixing zone analysis and advice for outfall design optimization [8]-[9].

A result of increasing erosion due to high precipitation rates are increasing the amount of solid substances carried into the rivers in the Black Sea. Suspended solid of the high value, the amount of solids transported by rivers is considered that due to the increase. The measurement results compared with the model results showed that 0.7 °C difference is acceptable. According to the model results, after mixing 10 meters into the sea of waste water has been obtained difference 1 °C. This difference is within acceptable limits as a regard of Turkish Water Pollution Regulation.

REFERENCES

- [1] Basaran, T., "Global Energy, Environment, Economic System and Hydrogen", Hydrogen Energy Course Project Report, Sabanci University, Istanbul, 2009
- [2] Zhao, Y., "An Integrated Framework for Gas Turbine Based Power Plant Operational Modeling and Optimization", Georgia Institute of Technology, PHD Thesis, Atlanta, USA, April 2005
- [3] I. S. Ondryas, D. A. Wilson, M. Kawamoto and G. L. Haub "Options in gas turbine power augmentation using inlet air chilling", *Trans ASME Journal of Engineering for Gas Turbines and Power*, vol.113, issue 2, pp. 203-211, April 1991.
- [4] Kehlhofer, R., *Combined Cycle Gas & Steam Turbine Power Plants*, 3rd ed., Penwell Publishing Company, Oklahoma, USA, 1997.
- [5] Ross, D.A. and Degends, E.T., *Recent sedimentation of Black Sea. In Degends, E.T. and Ross, D.A. (Eds.), The Black Sea-Geology-Chemistry-Biology the American Association of Petroleum Geologists*, No. 20, 183-199. 1974
- [6] Akturk, "Heavy metals in sediments of the black sea," In. Eng. Master of Science, Bogazici Institute of Environmental Science, Istanbul, Turkey, 2005.
- [7] Doneker R. L. And Jirka H. G. "CORMIX-GI systems for mixing zone analysis of brine wastewater disposal" *Desalination*, vol. 139, issue 1-3, pp. 263-274, Sep. 2001.
- [8] L.R. Davis, *Fundamentals of Environmental Discharge Modeling. CRC Mechanical Engineering Series*, Boca Raton, CRC Press, 1999.
- [9] D.J. Baumgartner, W.E. Frick and P.J. Roberts, *Dilution Models for Effluent Discharges*, 3rd ed., USEPA, Newport, OR, 1994.

BIOGRAPHY

Tolga Ayeri was born in Elazig, Turkey in 1990. He obtained a bachelor's degree from Ondokuz Mayıs University Environmental Engineering Department. Since 2015, he has been studying in Ondokuz Mayıs University for a master's degree. In 2015, he became a research assistant at the Ondokuz Mayıs University Environmental Engineering Department.

Production of Bio-pellets Derived from Sawdust and Crude Glycerol

Veli Gokhan Demir¹, Pasa Yaman¹, Mete Oguzhan Efe¹, Hayrettin Yuksel¹

Abstract

Biomass has a significant proportion among all of the renewable energy sources. Bio-pellets produced by pelletization of bulky biomass materials are widely favoured for combustion applications because of the improvements over biomass (sawdust, agricultural residues etc.) resulting in enable to utilize and store the biofuels. In recent researches it is stated that using crude glycerol (by-product of biodiesel production) can increase the calorific value of pellets and minimize the disposal problem of crude glycerol in biodiesel industry. In this study, the crude glycerol produced from the transesterification of sunflower oil was blended in different ratios (wt %) with the sawdust of Scots pine which is commonly used in Eurasian region. Moreover, maize starch was used to examine its additive effect in drop tests. According to the optimization study, 150 MPa pelletizing pressure with 7.5% glycerol- 92.5% sawdust ratios gave the optimum results and maize starch almost didn't improve the strength of pellets. It was measured that 7.5% glycerol pellets had 89.94% drop test resistance, 89.55% volatility, 10.06% moisture content and 0.75% ash content while pure sawdust pellet had 95.54% drop test resistance, 89.63% volatility, 10.03% moisture content and 0.43% ash content. Also, 7.5% glycerol addition to the sawdust as a raw material did not affect the net calorific value of the bio-pellets ($\approx 0.97\%$). As a result, it is expected that using crude glycerol directly in bio-pellet production contributes solving the disposal problem of biodiesel by-product and decreases the cost of biodiesel production.

Keywords: *Biodiesel, Biomass, Bio-pellet, Crude Glycerol, Sawdust.*

1. INTRODUCTION

Biomass, a renewable energy source, is getting more popular because of the environmental problems, increasing prices and depleting of fossil fuels [1]. For a long period of time, fossil fuels were regarded as harmful for the environment. In process of burning, a high amount of greenhouse gases (GHG) is emitted into atmosphere leading to a threat of global warming. It is reported that 80% rise in usage of fossil fuels results in 70% GHG output growth. Taking above into account scientists concentrated their attention on renewable energy and biomass-based fuels in particular [2].

Biomass is created of compounds obtained during process of photosynthesis and can be used as alternative to fossil fuels for both heating and electricity production [3]. In addition, due to high availability of biomass, it constitutes approximately 14% of world energy consumption [4]. However, storage of biomass is substantially more convenient compared to other renewable energy sources.

Bio-pellets are the most used biomass products producing via pelletization. Pelletization process increases bulk density and calorific value of pressed material [2]. Bio-pellets are made from forest residues, solid agricultural waste etc. and they are generally used in pellet stoves, pellet boilers and biomass power generators to obtain heat and electricity.

On the other hand, crude glycerol is produced in high amounts by biodiesel industry as a by-product. The estimations show that discharge of crude glycerol may cause serious environmental problems, and biodiesel industry may face with glycerol disposal problem if biodiesel production stays at the same high level. Figure 1 presents estimation for crude glycerol production up to 2020. Thus, it is necessary to find alternative and practical solutions for the excess crude glycerol [5, 6].

¹Corresponding author: Balıkesir University, Department of Mechanical Engineering, 10100, Balıkesir, Turkey.
veligokhandemir@balikesir.edu.tr

^{2,3,4}Balıkesir University, Department of Mechanical Engineering, 10100, Balıkesir, Turkey.

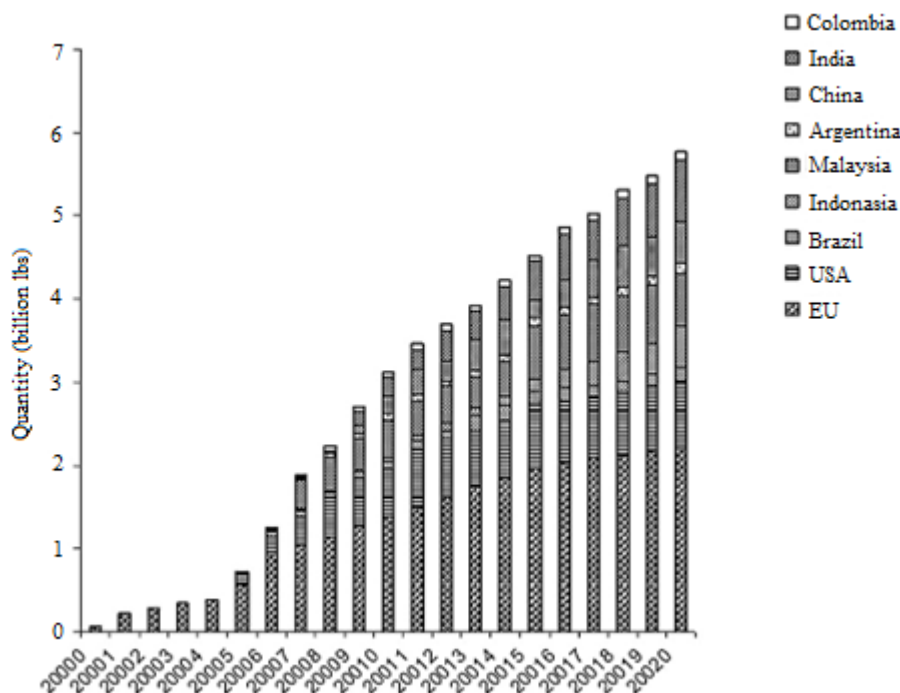

Figure 1. Crude glycerol production by different countries [6].

Purified glycerol is used in pharmaceutical, food and cosmetics industries; however, purification of crude glycerol requires high process cost, and glycerol market is already saturated. Instead of that, crude glycerol can be used in combustion, composting, animal feeding etc. directly [7]. In addition, in some investigations, using crude glycerol as an additive in bio-pellet production are examined and recommended [8,9].

In this study, we tried to define the optimum pelletization conditions using saw dust of Scots pine (*Pinus Sylvestris* L.) and crude glycerol at different amounts by measuring and analysing pellets' mechanic and fuel properties.

2. MATERIALS AND METHODS

2.1. Materials (Pellet contents)

Sawdust:

In this study, sawdust from Scots Pine (*Pinus Sylvestris*, L.) was used as raw material for pelleting process. Scots pine spread mostly over northern, western and central Europe and its extensity goes to east part of Eastern Serbia [10].

The Scots pine sawdust was provided from a timber plant in Yalova, Turkey. The sawdust had a size of 15-20 mm diameter. In order to pelletize the sawdust, the size of sawdust particles was reduced to 4-5 mm using a sieve having a pore size of 4.5 mm.

Crude Glycerol:

Crude glycerol was produced as a by-product of biodiesel production in the Renewable Energy Lab of Mechanical Engineering Department in Balikesir University, Turkey. In the biodiesel production process, sunflower oil was transesterified to its alkyl ester in the presence of methanol (6:1 molar ratio) and KOH (1-1.5%wt of oil).

The glycerol (crude glycerol) was obtained as a by-product at the end of the biodiesel production process as seen in Figure 2.

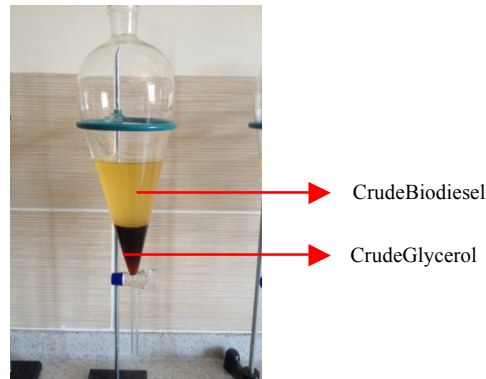

Figure 2. Crude glycerol and crude biodiesel in separate phases

The glycerol had a low viscosity in room temperature. It was heated at 45°C for 15 min to make it thinner and ease to mix ingredients. Otherwise, sawdust with glycerol forms a few globular particles which make the blend impossible to mix homogeneously.

Starch:

It is claimed that starch has a binding ability when it is mixed with hot water [11]. Maize starch and warm crude glycerol was mixed, thereby starch is activated as binding agent. In our research, we aimed starch to hold pellet particles together and increase mechanical durability. Maize starch was purchased from a local market.

2.2. Instruments

Pelleting system:

Mould for pelleting process was produced from St-37 material and has 50 mm outer diameter, 3 parts of the mould (piston, shell mould, stopper mould) were milled in CNC lathe in the BAUN, Mechanical Engineering Department Labs. The piston has 7.95 mm outer diameter, 100 mm length; the shell mould has 8 mm inner diameter, 100 mm length; stopper mould has 7.95 mm outer diameter and 30 mm length (Figure 3).

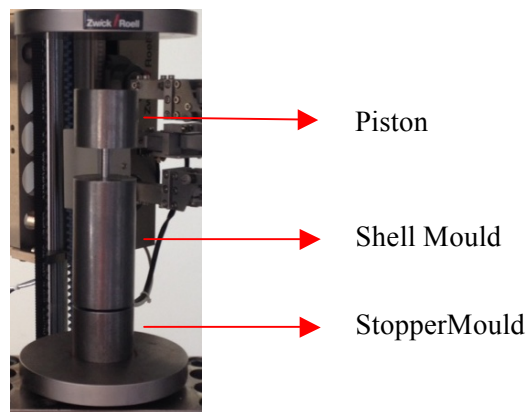

Figure 3. Pelleting mould

The mould was mounted to Zwick Roell Z250 Allround-Line material testing machine which has a nominal force of 250 kN. The bio-pellet productions were performed in this pelleting system.

Furnace:

PLF 110/45 model of Protherm 442 lab furnace (Figure 4) was used during the curing processes. It has a maximum temperature of 1100 °C and 45 litre internal volume. Technical specifications are 6000 Watt and 220 Volt AC.



Figure 4. Curing furnace

2.2. Defining Physical Properties of Sawdust and Pellets

2.2.1. Moisture Content

Moisture contents of samples were determined according to ASTM D-4442-07. At first, the samples were transferred to preheated furnace (100°C) and they were kept in at $105 \pm 2^\circ\text{C}$ for 3 hours. Equation (1) was used in moisture content calculations.

$$\text{Moisture Content} = \frac{(m_2 - m_3)}{(m_2 - m_1)} * 100 \quad (1)$$

m_1 : mass of empty glass container

m_2 : mass of empty glass container + sawdust/pellet (before heating)

m_3 : mass of empty glass container + sawdust/pellet (after heating)

2.2.2. Volatile Matter Content

According to the ASTM D 271-48, 1 g weighed pellets were kept in the furnace and heated at a fixed temperature of 950 °C for 7 min. The furnace was started from the room temperature and increased 10 °C per minute until 950 °C.

Volatile matter content was determined by measuring the mass loss. Mass of moisture excluded in the equation (2).

$$\text{Volatile Matter Content} = \frac{(m_2 - m_3)}{(m_1)} * 100 \quad (2)$$

m_1 : initial mass of pellet

m_2 : moisture mass of pellet

m_3 : volatile mass of pellet

2.2.3. Ash Content

According to the ASTM E 1755-01, 1 g weighed pellets kept in the furnace and heated at a fixed temperature of 750 °C for 120 min. The furnace was started from the room temperature and increased 10 °C per minute until 750 °C.

Ash content was determined by measuring the mass loss.

$$\text{Ash Content} = \frac{m_1}{m_2} * 100 \quad (3)$$

m_1 : mass of ash, after burning the pellet in the furnace

m_2 : initial mass of pellet

2.2.4. Calorific Value

Net calorific values (Lower Heating Value) of pellets were measured according to the TS ISO 1928 standard. The analyses were carried out by İnönü University Fuel/Oil Analysis Laboratory in Malatya, Turkey.

2.2.5. Mechanical Durability

Drop resistance of pellets was examined by dropping pellets from a height of 1.85 m on a faience plane[12]. Pellets were weighed before and after drop tests. An equation (4) of durability was equated according to mass loss in pellets.

$$\text{Drop Test Resistance} = \frac{m_1}{m_2} * 100 \quad (4)$$

m_1 : mass after drop test

m_2 : mass before drop test

2.3. Production of Pellets

In this work, the disposal problem of biodiesel by-product glycerol is defined as the main goal. Therefore, maximum glycerol added to pellet production method and condition was investigated. The bio-pellets containing 0.5 wt% glycerol (G0.5) to 75 wt% glycerol (G75) were produced. Also pure sawdust pellets (G0), and starch added pellets were produced to compare with glycerol added ones.

2.3.1. Pelleting Pressure

First of all, optimum pelleting pressure was specified. In the literature, the most preferred pressure values are at the range of 50 to 150 MPa. The pelleting study was conducted at a pressure of 150 MPa because commercial roll press briquetting or pelleting machines operate at or around 150 MPa pressure [12]. Thereby, in our experiments 50, 100 and 150 MPa pelleting pressures were applied, respectively.

The bio-pellets primarily compressed with 50 MPa pressure and it was clear that pure sawdust pellets and glycerol added pellets were not firm enough to transport. Then, they were pelleted with 100 MPa pressure. The appearances of bio-pellets started to look solid and uniform, however it was not enough as well. The optimum pelleting pressure was attained at 150 MPa, with a holding. By a visual inspection it was obvious that the bio-pellets were solid and strong to transport, therefore optimization study in this article was accomplished solely with 150 MPa.

2.3.2. Glycerol Percentage

Firstly, in order to see the effect of glycerol on pellet's mechanic properties, roughly, G0, G25, G50 and G75 pellets were produced. Almost all of the samples lost some of its glycerol. Glycerol flowed in the die during the pelleting process due to the high pressure. The pellets tended to be elongated and deformities occurred because of high glycerol contents. It was observed that high amounts of glycerol (>25%) in sawdust have not enough resistance to transport. G25 was defined as the maximum percentage of glycerol amount which could be added to pellet, however, it did not even seem a solid shaped pellet (Figure 5).



Figure 5. The bio-pellets: (a) G0 pellets, (b) G25 pellets

Because of the concerns about mechanical properties of the pellets, G0.5, G1, G1.5, G2, G2.5, G5, G7.5, G10, G15, G20, G25 pellets were produced. It can be seen that (Figure 6) high glycerol ratios make the pellets indurable to transport.

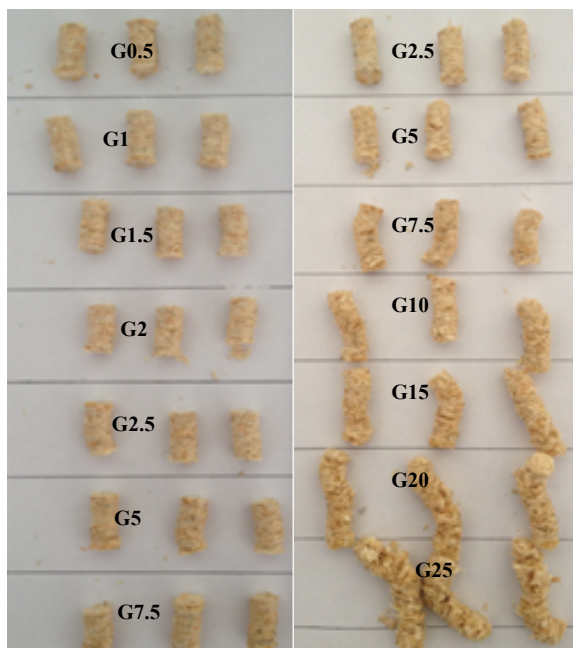

Figure 6. The appearances of glycerol added bio-pellets from G0.5 to G25

The experiments showed that the pellets which have desired strength levels should contain 7.5% glycerol or less (Table 1).

Table 1. The Drop resistances of bio-pellets from G0.5 to G7.5

Glycerol Percentage	Resistance %
G0.5	96.46
G1	97.36
G1.5	89.52
G2	88.59
G2.5	87.91
G5	83.03
G7.5	89.94

Pellets which have 10% glycerol or more did not require a drop test because it was observed after a day that G10 or more pellets were crumbling easily, even without contact. It was understood from the appearance that they were not appropriate for transport.

The lower percentage of 7.5 showed high resistance in drop tests but, in terms of high amount of crude glycerol production around the world as by-product of biodiesel, it would not have big influence on disposal problem of crude glycerol.

2.3.3 Effect of Adding Binding Agent

According to [11], starch may function as an adhesive agent. Gelatinizing of starch in the presence of water, in ratio of at least 1.5:1 (water: starch), and heat is the key to explain the natural binding capabilities of this chemical component. In this study, starch was selected as an adhesive to increase the glycerol rate in pellets. Additives of 2.5%, 5%, 7.5%, 10% (wt/wt) starch to G2.5, G5, G7.5, G10, G15 pellet materials were examined. (2.5% starch = S2.5) The pellet samples were produced in 150Mpa pelleting pressure, and they were analysed according to the drop test results (Table 2).

Table 2. The Drop resistances of bio-pellets with different additives

Glycerol Percentage	Resistance %
G2.5 + S2.5	96.50
G2.5 + S5	90.42
G2.5 + S7.5	92.28
G2.5 + S10	84.22
G5+ S2.5	89.05
G5+ S5	93.21
G5+ S7.5	90.06
G5+ S10	88.91
G7.5+ S2.5	94.33
G7.5+ S5	98.09
G7.5+ S7.5	84.23
G7.5 + S10	92.47
G10 + S2.5	40.74
G10 + S5	77.63
G10 + S7.5	64.91
G10 + S10	55.80

In the mechanical tests, it was observed that a trace amount of differences were seen between glycerol pellets with and without starch. Hence, starch was not used as adhesive in glycerol sawdust pellets owing to the incremental cost of starch and non-remarkable addition to the pelleting process.

2.3.4 Defining Fuel Properties of Pellets

According to the results, it was decided to produce G0 and G7.5 pellets to observe their mechanical durability, calorific value, moisture content, volatile content and ash content values. The results are shown in Table 3.

Table 3. Properties of bio-pellets

Test Type	Test Standard	G0	G7.5
Moisture Content	ASTM D-4442-07	10.03%	10.06%
Volatile Content	ASTM D 271-48	89.63%	89.55%
Ash Content	ASTM E 1755-01	0.43%	0.75%
Net Calorific Value	TS ISO 1928	4640 cal/g	4595 cal/g
Drop Resistance	ASTM D 440-86	95.54%	89.94%

3. DISCUSSION

As a result of the experiments, 50 and 100 MPa pelleting pressures are deficient to press and shape pellets compared to 150 MPa. Regarding the drop tests, all the pellet samples having less than %10 glycerol show similar characteristics to each other. Excess glycerol prevents solid shaping and minimizes the strength of pellets. Besides, the starch does not affect the drop results considerably. Thereby, using starch as an additive is redundant and it causes additional cost. The moisture contents of G0 and G7.5 pellets are 10.0328% and 10.0568%, respectively. Adding glycerol has no influence on the moisture contents of pellets; furthermore, the results are at the range of 8-12% as declared in the literature [13]. G0 pellet has 89.6251% while G7.5 pellet has 89.5518% volatile matter. The volatile matter of pellets is not affected from glycerol as well as moisture content. According to the literature [15], glycerol increases the ash content of pellets due to the molecular contents of glycerol. The ash contents of pellets are: 0.4325% for G0, and 0.7524% for G7.5 as it is expected. Net calorific values of pellets were found as 4640 cal/g for G0 and 4595 cal/g for G7.5. Although it is stated that adding glycerol to bio-pellet increases the calorific value of products [8]; in our experiments, glycerol decreased the calorific value of pellets so slightly (0.97%). The crude glycerol were directly taken from the separating funnel, and it included water, wax, residual catalysts and other ingredients which may have caused the decrease of net calorific value. Regards the ENplus handbook (version 3.0, August 2015) [16],

net calorific value of pellet must be more than 19 MJ/kg, and G7.5 is a suitable fuel in this case (≈ 19.2 MJ/kg). Consequently, the optimum bio-pellet production conditions are found as 150 MPa pelleting pressure and 7.5% glycerol-92.5% Scots Pine sawdust ratio (wt/wt).

4. CONCLUSION

This paper reports the defined optimum pelletization conditions and characterization of bio-pellets derived from Scots Pine sawdust and crude glycerol at different ratios. According to the experiments, pure sawdust and 7.5% crude glycerol (wt/wt) added bio-pellets gave very similar results as a fuel. From the results obtained, the following conclusions can be made:

- The use of glycerol in bio-pellet production could contribute solving the biodiesel industry's disposal problem. Also, selling glycerol can decrease the production cost of biodiesel.
- Crude glycerol added bio-pellets can be used for combustion purposes in furnaces, boilers etc. with results similar to traditional wood fuel.
- By widespread utilization of glycerol added bio-pellets, consumption of fossil fuels could be decreased. Thereby, less damaging effect of the environment can be provided in combustion processes.

REFERENCES

- [1] J. Van Dam, M. Junginger, A. Faaij, I. Jürgens, G. Best, and U. Fritsche, "Overview of recent developments in sustainable biomass certification," *Biomass and Bioenergy*, vol. 32, Issue 8, pp. 749-780, 2008.
- [2] H. Shahruckh, A.O. Oyedun, A. Kumar, B. Ghiasi, L. Kumar, S. Sokhansanj, "Techno-economic assessment of pellets produced from steam pretreated biomass feedstock," *Biomass and Bioenergy*, vol. 87, pp. 131-143, 2016.
- [3] R. Luque, R. Davila, J. Campelo, and J. Clark, "Biofuels: A technological perspective," *Energy and Environmental Science*, vol. 5, Issue 1, pp. 542-564, 2008.
- [4] R. Saidur, E. A. Abdelaziz, A. Demirbas, M. S. Hossain, and S. Mekhilef, "A review on biomass as a fuel for boilers," *Renewable and Sustainable Energy Reviews*, vol. 5, Issue 15, pp. 2262-2289, 2011.
- [5] M. Ayoub and A. Z. Abdullah, "Critical review on the current scenario and significance of crude glycerol resulting from biodiesel industry towards more sustainable renewable energy industry," *Renewable and Sustainable Energy Reviews*, vol. 16, pp. 2671-2686, 2012.
- [6] (2007) [Online]. Available: http://www.asasea.com/download_doc.php
- [7] V. G. Demir, H. Yuksel, and H.S. Soyhan, "The Diversity of Using Glycerol as a By-product of a Biodiesel Production," in *ICOEST 2015*, 2015, paper no 120.
- [8] O. Chavalparit, M. Ongwandee, and K. Trangkprasith, "Production of Pelletized Fuel from Biodiesel Production Wastes: Oil Palm Fronds and Crude Glycerin," *Engineering Journal*, vol.17, pp.61-70, 2013.
- [9] (2015) University of California Riverside Website [Online]. Available:<http://www.ugrj.ucr.edu/journal/volume2/SeanBrady.pdf>
- [10] M. Giertych, C. Matyas, *Genetics of Scots Pine*, Amsterdam, Netherlands: Elsevier Science Publishers, 1991.
- [11] M. Thomas, T. Van Vliet, A.F.B van der Poel, "Physical quality of pelleted animal feed 3. Contribution of feedstuff components," *Animal Feed Science Technology*, vol. 70, pp. 59-78, 1998.
- [12] N. Kaliyan, R.V. Morey, "Factors affecting strength and durability of densified biomass products," *Biomass Bioenergy*, vol. 33, pp. 337-359, 2009.
- [13] T. Ashwini, A. Ramin, D. Mark, D. Ajay, K. Janusz, "Canola meal moisture-resistant fuel pellets: Study on the effects of process variables and additives on the pellet quality and compression characteristics," *Industrial Crops and Products*, vol. 63, pp. 337-348, Canada, 2015.
- [14] O. F. Obi, "Evaluation of the effect of palm oil mill sludge on the properties of sawdust briquette," *Renewable and Sustainable Energy Reviews*, vol. 52, pp. 1749-1758, 2015.
- [15] L. Raslavicius, "Characterization of the woody cutting waste briquettes containing absorbed glycerol," *Biomass and Bioenergy*, vol. 45, pp. 144-151, 2012. (2016) The ENplus website. [Online]. <http://www.enplus-pellets.eu/downloads/enplus-handbook/>

BIOGRAPHY

Veli Gökhan DEMİR graduated from mechanical engineering at Sakarya University in 2008. He has a master degree in mechanical engineering from Balıkesir University and he has been a Ph.D. student since 2011. In his Ph.D. work, he has investigated about production of biofuels and their combustion efficiencies. His main research interests are in the field of energy efficiency improvement, biomass energy utilization, and combustion in engines. Currently, he is a research assistant in mechanical engineering at University of Balıkesir.

Biodiesel Production Using Wet and Dry Purification Methods

Veli Gokhan Demir¹, Baybars Ali Fil², Vedat Demirtas³, H. Serhad Soyhan⁴

Abstract

In biodiesel production via transesterification, after removing glycerol from crude biodiesel, purification process must be performed before using biodiesel as a fuel that meets the EN 14214 standard. In the literature, various processes are presented for purification of biodiesel however; dry and wet washing methods are mostly recommended because of their higher efficiencies and easier applicabilities. In this study, methyl esters (biodiesel) derived from waste frying oil (WFO) and sunflower oil were generated using transesterification technique in the presence of KOH and methanol in a novel microwave assisted biodiesel reactor. For purification of crude biodiesel, two different methods; washing with distilled water as wet washing, and with magnesol as dry washing were carried out and compared. According to the results, dry washing method improved biodiesel yield and ester content, it also reduced the purification process time considerably.

Keywords: Biodiesel, Transesterification, Purification Techniques.

1. INTRODUCTION

The chemical process, transesterification includes a TAG (triglycerides) reaction with a short chain monohydric alcohol in the presence of a catalyst to obtain biodiesel which is defined as fatty acid alkyl esters (FAAE), and by-product glycerol. Three moles of alkyl esters and one mole of glycerol are formed for every mole of TAG that undergoes complete conversion reaction [1]. In transesterification reactions, presence of sufficient amount of methanol is essential to break the glycerol-fatty acid linkages [2]. Methanol is the most commonly used alcohol in commercial biodiesel production via transesterification, since it is generally less expensive than other alcohols. There are different types of catalysts used in chemical reactions, among them; homogenous alkali catalysts (sodium or potassium hydroxide or methoxide etc.) are inexpensive catalysts generally used in commercial biodiesel production from refined or treated oils. Beside of the economic issues and concerns, homogenous alkali catalysts are more preferred than acid catalysts and enzymes due to their high reactivity and short reaction time requirements [1, 3]. Also, another reason for widely using alkali catalyzed biodiesel production techniques is this method's being less corrosive than others [4].

At the end of the alkali transesterification reactions, the by-product glycerol is removed from the crude alkyl ester-glycerol mixture. In addition, crude ester must be purified to obtain high quality biodiesel which must meet international standard specifications (EN14214, ASTM D6751 etc.) by removing excess contaminants (methanol, catalyst etc.) and impurities (soap, wax etc.) [5]. In commercial biodiesel production, purification method is called as washing process, and it is categorized into 2 techniques as: wet and dry washing [6]. Besides these, alternative washing method, membrane extraction has been investigated [7].

1.1 Wet Washing

Wet washing method is more traditional and widely used for removing containing the unreacted oil, excess catalyst and alcohol, salts, soaps, organic impurities etc. from crude biodiesel. In wet washing process, water is used for purification. Water has the ability to provide a means for addition of acid to neutralize the unreacted alkali catalyst. Wet washing method simplifies removal of the salt products formed in transesterification reaction. The unreacted (excess) alcohol after transesterification should be removed before the washing process to decrease the amount of alcohol in the residual wastewater. Also, some researchers such as Van Gerpen et al. suggest removing process of excess alcohol after the end of wet washing [8, 9]. The researchers prevented precipitation of saturated fatty acid esters using distilled water ($\approx 50-60^{\circ}\text{C}$). Emulsion generation is retarded when gentle water washing is applied fostering rapid and complete phase separation [8]. The washing with hot distilled water results in the biodiesel purity of 99% [10]. Both of the dry and wet washing methods are used in commercial biodiesel production, however, it is

¹ Corresponding author: Balikesir University, Department of Mechanical Engineering, 10100, Balikesir, Turkey.
veligokhandemir@balikesir.edu.tr

² Balikesir University, Department of Environmental Engineering, 10100, Balikesir, Turkey.

³ Afyon Kocatepe University, Department of Mechanical Engineering, 10100, Afyon, Turkey.

⁴ Sakarya University, Department of Mechanical Engineering, 54187, Sakarya, Turkey.

claimed that only wet washing process can purify the biodiesel in desired levels, and the purified biodiesel meets the EN14214 standards [6].

Beside the advantages of wet washing, Low et al. [11] declared that this method has some drawbacks such as long separation time and loss of product yield. The loss of biodiesel yields in the rinsing water increases the formation of polluted liquid effluent [12]. In addition, the large amount of biodiesel wastewater formed after wet washing process causes an enormous problem for the biofuel industry and environment. Veljković et al. [13] reported that the generated biodiesel wastewater was about 28 million m³ in 2011 in the world.

1.2 Dry Washing

Using absorbents is another method of treating crude biodiesel. Dry washing technique generally uses ion exchangers or a magnesium silicate powder as absorbents [6]. These materials are utilized to replace the usage of distilled water in order to remove the impurities and purify crude esters. At the end of the dry washing, filtration is ordinarily carried out for improving efficiency of the process. The advantages of dry washing can be described as: no waste water is generated and the total surface area coverage of the wash tank is minimized. Besides, this washing method has important advantages such as: strong affinity to polar compounds, easy to install into biodiesel processor plant, dramatically lower washing time, solid waste can be used in various ways, saves space etc. The main preferred absorbents in biodiesel production are defined as magnesol, ion exchange resin, activated carbon, activated fiber etc. [14].

Magnesol is used in many investigations and suggested by the authors. Sabudak and Yildiz [15] made a comparison of hot water washing (50%-V/V and 50°C) and dry washing with magnesol (1 wt%) according to the ester contents of methyl esters. They produced biodiesel from waste cooking oil by 3 different processes. In the event of one step alkali transesterification, they achieved 80.8% and 84.9% ester contents with wet washing and dry washing, respectively. In two step alkali transesterification, 91.0% ester content was obtained by wet washing while 92.3% by dry washing. In the third process (two step acid-alkali transesterification), 95.6% and 96.9% ester contents were measured at the end of the wet and dry washing processes, respectively. As a result, it was found that dry washing enhanced the ester content of crude biodiesel more than wet washing, in addition, only the samples purified by dry washing fulfilled with EN14214 ester content standards (min.96.5%). Berrios and Skelton [6] purified crude biodiesel samples using 0.25, 0.50, 0.75 and 1.00% magnesol concentrations at the temperature of 60 °C. 10 min and 20 min washing time were experimented while standard washing time is known as 30 min. A vacuum filtration and a water ejector were performed in separating process. With the exception of the experiments with 0.25% (wt/wt) magnesol concentration, all the experiments remove in satisfactory way the glycerol content in 10min of reaction. The same happened in the soap removal. They specified that min 0.75% magnesol concentration is needed with a washing time of 10 min; and it is necessary a previous methanol removal to avoid the saturation of the adsorbents. Also, none of the experiments decreased the methanol content below the defined level of the EN14214 Biodiesel Standards, and the best result was obtained using with 1%(wt/wt) magnesol concentration at 60°C temp. Bryan [16] applied dry washing technique in the presence of magnesol (1%) on both soybean and yellow grease crude biodiesels, also he used wet washing technique to compare those two methods clearly. The physicochemical properties of purified methyl esters (soybean&grease based) by dry washing method were fulfilled with EN 14214 and ASTM D6751 standards. Moreover, the researcher claimed that magnesol treated sample of yellow grease derived methyl esters met all ASTM standards while the water washed and dried sample did not. The author remarked that magnesol has a strong affinity for polar compounds, thereby actively filtering out metal contaminants, mono and di-glycerides, free glycerin, and excess methanol as well as free fatty acids and soap.

1.3 Objectives

As it is seen in section 1.1 and 1.2., conflicting outcomes exist in the literature about dry and wet washing purification methods. Thereby, the main objective of the study has been determined as comparing the wet washing method with hot distilled water and dry washing method with magnesol based on the obtained ester content amounts and yields of purified biodiesel samples. In the experiments, the biodiesel samples were produced via alkali catalyzed transesterification in various reaction conditions.

2. MATERIAL AND METHOD

2.2 Materials

In the experiments, methanol and KOH were used as an alcohol and a catalyst. The raw materials were determined as waste frying oil (WFO) with an FFA value ≈0.2% which was collected from local restaurants in Balıkesir, Turkey, and sunflower oil was supplied from an oil production plant. Methanol and KOH were purchased from Sigma-Aldrich, and magnesol (MgO:SiO₂ (1:2.7)) from Dallas Group of America.

2.3 Equipment

Biodiesel reactor:

The biodiesel processor system has 60 L capacity and it is composed of a reactor tank, a microwave heating system, a mechanic stirrer, a circulation pump, and a PLC circuit and software to control reaction parameters (temp, mixing rate etc.).

Wet washing:

The distilled water was produced from a water distillation system, and the washed crude biodiesel samples were settled in separatory funnels.

Dry washing:

In order to heat crude biodiesel samples filled into the beakers, the magnetic hotplate stirrer (Dragon-MS-H280-Pro) was used. In the filtering process, a vacuum pump and filters (pore sizes: 10 μm and 1.2 μm) were utilized.

2.4 Biodiesel Production

Reaction parameters:

In order to achieve maximum conversions, 6:1 molar ratio of methanol to oil is recommended in the literature[17]. Thereby, 6:1 molar ratio was fixed in all experiments we carried out. The catalyst loadings were defined as 1 wt% KOH for sunflower oil, and 1 wt% and 1.5 wt% for waste cooking oil. Because, the FFA of waste oils are higher than vegetable oils and free fatty acids can react with alkali catalysts to soap and water formation, and saponification consumes alkali catalysts [3]. In all the experiments, reaction temperature was set to 60°C.

Methyl ester formation:

Methyl ester production was realized in our novel microwave assisted biodiesel reactor in the defined production conditions, and two washing methods were performed to the same products after the settling processes. The main steps of biodiesel production are shown in Figure 1.

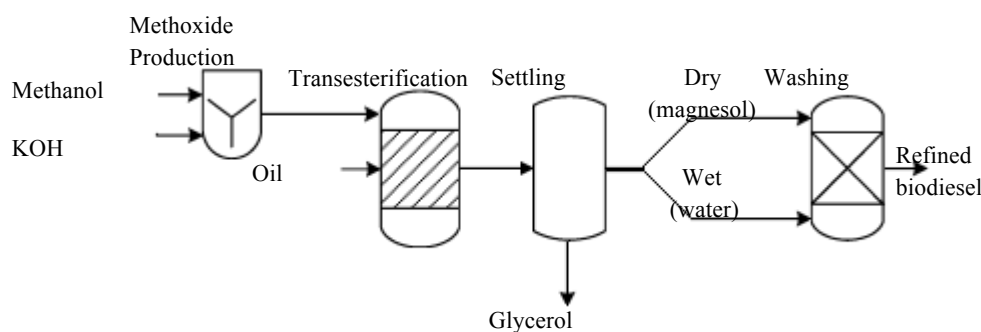

Figure 1. Schematic diagram of the biodiesel productions

Firstly, some physical and chemical properties of oils were determined (Table 1). Fatty acid compositions of oils were analyzed (IUPAC IID19) using Gas Chromatography (GC), and the average molecular weight of oils were calculated. Then the amounts of methanol and KOH were defined for each experiment. The density (EN ISO 3679), kinematic viscosity (EN ISO 3104), and methyl ester content (EN 14103) tests were performed on biodiesel or oils by using a pycnometer, a viscometer (AKV-202-TANAKA), and the ester contents were measured in İnönü University Fuel / Oil Analysis Laboratory in Malatya, Turkey.

Table 1. Some properties of WFO and Sunflower oil

Properties	Unit	WFO	Sunflower Oil
Density (15°C)	g cm^{-3}	0.925	0.921
Viscosity (40°C)	$\text{mm}^2 \text{s}^{-1}$	36.47	32.57
Acid value	mg KOH g^{-1}	0.69	0.26
Avr. molecular weight	g.mol^{-1}	879.14	879.82

In the first step of methyl ester production, methanol and KOH were added into the methoxide tank and the methoxide solution was formed. Then the methoxide was transferred to the reactor, into the preheated oil. Transesterification reactions were carried out at 60°C and the crude biodiesel samples were taken at different time intervals, and they were placed in the separatory funnels. After the settling processes, two layers were observed as it is seen in Figure 2 (the upper layer is the biodiesel phase, the lower layer is the crude glycerol), and the glycerol layers were removed. Finally, the crude biodiesel samples were purified by two different methods.

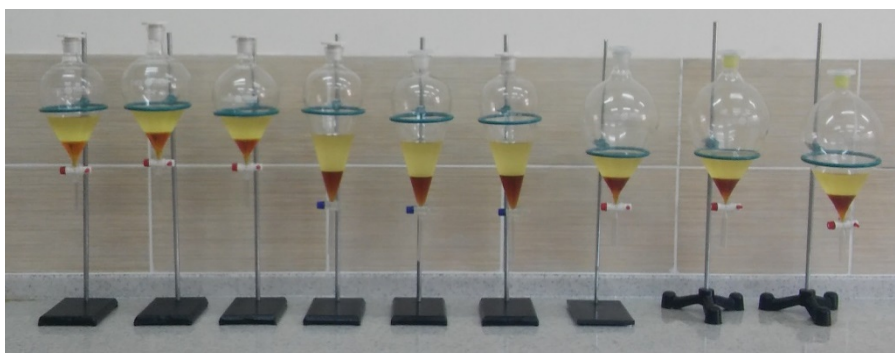

Figure 2. Crude biodiesel and glycerol layers

2.5 Purification Process

As regards previous investigations about biodiesel production from WFO, the optimum result (by wet washing) was achieved with 20 min transesterification reaction while max reaction time was defined as 90 min. However, when sunflower oil was used as raw material, it was observed that the reaction was completed in a very short time, and at the end of the 20 min, 98.30% ester content was achieved. Thereby, the purification techniques were applied to the crude biodiesel samples produced in 20 min and 90 min.

2.5.1 Wet washing (water)

After removing the glycerol layers from the separatory funnels, warm distilled water at 55°C was added into the each crude biodiesel samples, and the water-biodiesel mixtures were gently shaken. Then they were waited for settling, and two layers occurred as it is seen in Figure 3a and Figure 3b (the upper layer is washed biodiesel, the lower layer is waste water). The down layers were removed and the biodiesel layers were washed three times more. In the first three washing processes, the settling time was defined as 60 min while in the final washing the sedimentation time was performed as 360 min to provide the separation exactly. In order to remove undesired components such as the excess methanol or existing water, the washed biodiesel samples were dried at 110 °C until they were appeared crystal clear. At least, the final products were filtered using filter paper.

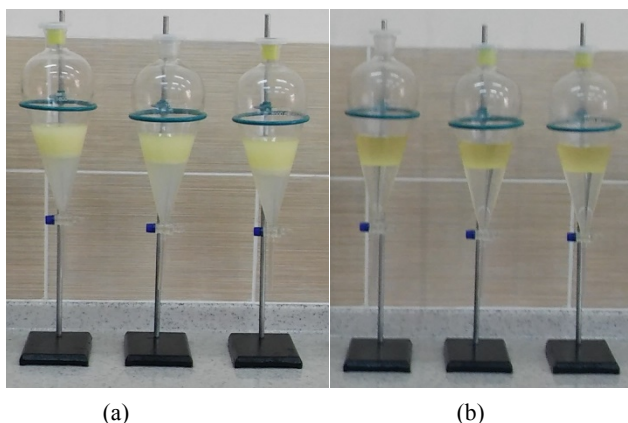

Figure 3. Biodiesel and wastewater layers: (a) 1st wash, (b) 4th wash

2.5.2 Dry washing (magnesol)

In the dry washing processes with magnesol; at first, the glycerol layers were removed from biodiesel layer as same as the section 2.4.1. The crude biodiesel samples were transferred to the beakers and they were heated to 65°C. The magnesol absorbents (1 wt%) were filled into the beakers and the mixtures were stirred for 30 min at constant 65°C (Figure 4a). At the final stage, the mixtures were filtered in two steps (10 μm and 1.2 μm) under vacuum (Figure 4b). The initial and final appearance of used magnesol is shown in Figure 5. In this study, the experiments containing dry washing method, crude biodiesel samples were purified directly, however, one sample was dried at 110°C to evaporate existing methanol and water before the purification process to observe the difference.

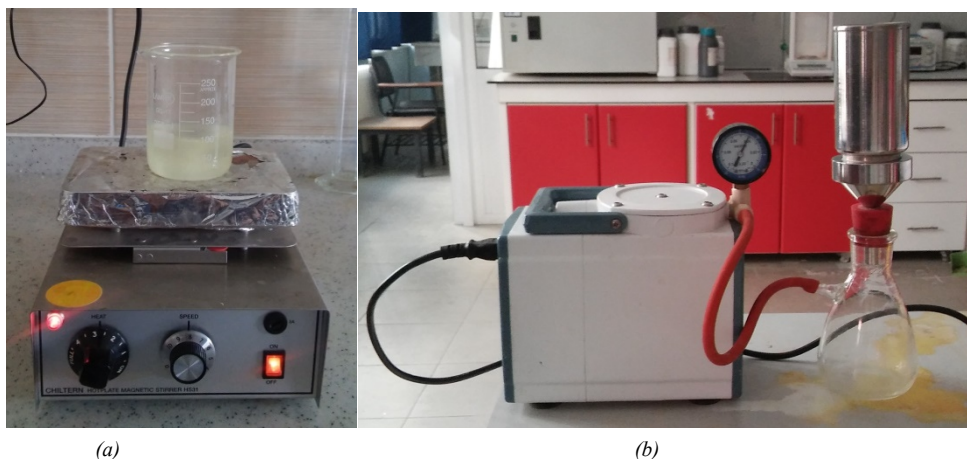

Figure 4. (a) Stirring process of crude biodiesel-magnesol mixture, (b) Filtering process using vacuum pump



Figure 5. The magnesol absorbent before and after the purification process

3. RESULTS AND DISCUSSION

Ester content (purity) is the main biodiesel property to analyze the transesterification efficiency and completion rate. Moreover, the purity level of biodiesel has a strong effect on fuel properties and on engine life. On the other hand, the main goal of transesterification reaction is decreasing the high viscosity value of oil, and density of biodiesel is a significant property affecting combustion process with viscosity. Thereby, these three main biodiesel properties were measured and analyzed, and wet and dry washing techniques were compared according to these values. In table 2 and 3, the differences of fuel properties and product yields related to used washing methods and raw materials are shown clearly.

Table 2. Fuel properties of the WFO based biodiesel samples.

Reaction time	Purification Processes	Density	Viscosity	Ester content (%m/m)	Product yield ($\frac{m_{biodiesel}}{m_{oil}}$) (%)
		(15°C) (kg/m ³)	(15°C) (mm ² /s)		
20 min	Wet washing	882	4.592	94.41	97.45
20 min	Dry washing	886	4.642	94.51	97.51
20 min (1.5%KOH)	Wet washing	874	4.784	94.27	94.64
20 min (1.5%KOH)	Dry washing	889	4.845	94.49	96.62
90 min	Wet washing	878	4.568	94.41	94.54
90 min	Dry washing	888	4.852	95.12	94.56
90 min	<u>2 step process:</u>	870	4.566	95.76	92.31
	1 st Wet washing				

Table 3. Fuel properties of the sunflower based biodiesel samples.

Reaction time	Purification Processes	Density	Viscosity	Ester content (%m/m)	Product yield ($\frac{m_{biodiesel}}{m_{oil}}$) (%)
		(15°C) (kg/m ³)	(15°C) (mm ² /s)		
20 min	Wet washing	877	4.628	98.30	96.92
20 min	Dry washing	871	4.611	98.52	96.99
20 min	<u>2 step process:</u>	868	4.618	98.82	95.17
	1 st Wet washing				
90 min	Wet washing	875	4.711	96.85	92.14
90 min	Dry washing	880	4.687	98.28	96.06
90 min	Dry washing	873	4.655	99.73	94.63
	(After evaporating methanol) <u>2 step process:</u>				
90 min	1 st Wet washing	881	4.723	98.63	89.26

According to the results; 20 min WFO based and 90 min sunflower based biodiesel productions, dry washing method using magnesol increased the ester content compared to wet washing at the ratios of 0.22% and 1.43%, respectively. Also, the dry washing method performed after evaporating process gave the best ester content value in all experiments. This method increased the ester content ratios at the range of 1.45% (90 min transesterification) compared to the dry washing method. Absence of methanol and water in crude biodiesel must have contributed to enhance the efficiency of magnesol in absorbing the impurities (soap, glycerol etc.). When these two methods were applied consecutively, the increments in the ester contents were achieved as: ≈1.3% in WFO based biodiesel production (90 min), ≈0.5% in sunflower oil based biodiesel production (20 min) compared to wet and dry washing. In addition, the increments of 1.78% and 0.35% (90 min) were measured compared to wet washing and dry washing in sunflower oil based biodiesel production, respectively. In terms of product (purified biodiesel) yields, dry washing method gave the best results, and the two step purification techniques caused poor yield ratios. Regarding the density

and viscosity properties, all the purification methods gave the suitable results according to the EN14214 standards. As seen in Table 2 and 3, the densities varies at the range of 868-888 kgm⁻³, the viscosity values varies at the range of 4.568-4.726 mm²s⁻¹ while the EN14214 limits are 860-900 kgm⁻³ for density and 3.5-5 mm²s⁻¹ for viscosity of biodiesel.

According to the washing methods' practicability and fastness, dry washing method becomes prominent by reducing purification time dramatically. It minimized the process time up to 30 min from 540 min compared to wet washing method, moreover it does not require a washing tank and a water distiller system.

4. CONCLUSION

As a result of this study, it is observed that dry washing method is a more practical and efficient technique compared to wet washing (water) method. Dry washing method takes about less than 18 times than wet washing method, also it increases ester content and yield of biodiesel. In addition, evaporating methanol and water before dry washing improves purity (ester content) of biodiesel a little more. Applying wet and dry washing processes together increases ester content in comparison to wet washing and dry washing method however, it does not increase the ester content noticeably and it reduces product yield. This study shows that the optimum method for purifying crude biodiesel is dry washing.

ACKNOWLEDGMENT

This work was supported by Scientific Research Projects Coordination Unit of Balıkesir University. Project No: 2016/09.

REFERENCES

- [1]. B.R. Moser, "Biodiesel production, properties, and feedstocks," *In Vitro Cellular & Developmental Biology-Plant*, 45(3). p. 229-266, 2009.
- [2]. M.I. Al-Widyan and A.O. Al-Shyoukh, "Experimental evaluation of the transesterification of waste palm oil into biodiesel," *Bioresource technology*, 85(3). p. 253-256, 2002.
- [3]. Y. Zhang, M. Dube, D. McLean and M. Kates, "Biodiesel production from waste cooking oil: 1. Process design and technological assessment," *Bioresource technology*, 89(1). p. 1-16, 2003.
- [4]. M. Jayed, H. Masjuki, R. Saidur, M. Kalam and M.I. Jahirul, "Environmental aspects and challenges of oilseed produced biodiesel in Southeast Asia," *Renewable and Sustainable Energy Reviews*, 13(9). p. 2452-2462, 2009.
- [5]. N.M. Daud, S.R.S. Abdullah, H.A. Hasan and Z. Yaakob, "Production of biodiesel and its wastewater treatment technologies: A review," *Process Safety and Environmental Protection*, 94. p. 487-508, 2015.
- [6]. M. Berrios and R. Skelton, "Comparison of purification methods for biodiesel," *Chemical Engineering Journal*, 144(3). p. 459-465, 2008.
- [7]. D.Y. Leung, X. Wu and M. Leung, "A review on biodiesel production using catalyzed transesterification," *Applied energy*, 87(4). p. 1083-1095, 2010.
- [8]. I. Atadashi, M. Aroua and A.A. Aziz, "Biodiesel separation and purification: a review," *Renewable Energy*, 36(2). p. 437-443, 2011.
- [9]. J. Van Gerpen, B. Shanks, R. Pruszko, D. Clements and G. Knothe, *Biodiesel Production Technology, National Renewable Energy Laboratory Subcontractor Report NREL*. 2004, SR-510-36244.
- [10]. F. Karaosmanoglu, K.B. Cigizoglu, M. Tüter and S. Ertekin, "Investigation of the refining step of biodiesel production," *Energy & Fuels*, 10(4). p. 890-895, 1996.
- [11]. S. Low, G. Gan and K. Cheong, "Separation of methyl ester from water in a wet neutralization process," *Journal of Sustainable Energy & Environment*, 2(1), 2011.
- [12]. S. Kumjadpai, K. Ngamlerdpokin, P. Chatanon, P. Lertsathitphongs and M. Hunsom, "Management of fatty acid methyl ester (fame) wastewater by a combined two stage chemical recovery and coagulation process," *The Canadian Journal of Chemical Engineering*, 89(2). p. 369-376, 2011.
- [13]. V. Veljković, O. Stamenković and M. Tasić, "Wastewater management in biodiesel production," *Reporting For Sustainability*. p. 471-475, 2013.
- [14]. I. Atadashi, M. Aroua, A.A. Aziz and N. Sulaiman, "Refining technologies for the purification of crude biodiesel," *Applied energy*, 88(12). p. 4239-4251, 2011.
- [15]. T. Sabudak and M. Yildiz, "Biodiesel production from waste frying oils and its quality control," *Waste management*, 30(5). p. 799-803, 2010.
- [16]. T. Bryan, Adsorbing It All. (2016); Available from: <http://www.biodieselmagazine.com/articles/239/adsorbing-it-all>.
- [17]. R. Turck, *Method for producing fatty acid esters of monovalent alkyl alcohols and use thereof*. 2003, Google Patents; L. Meher, D.V. Sagar and S. Naik, "Technical aspects of biodiesel production by transesterification—a review," *Renewable and sustainable energy reviews*, 10(3). p. 248-268, 2006.

BIOGRAPHY

Veli Gökhan DEMİR graduated from mechanical engineering at Sakarya University in 2008. He has a master degree in mechanical engineering from Balıkesir University and he has been a Ph.D. student since 2011. In his Ph.D. work, he has investigated about production of biofuels and their combustion efficiencies. Currently, he is a research assistant in mechanical engineering at University of Balıkesir.

Utilization of Olive Cake in Biofuel Industry as Pellet and Briquette Fuels

Veli Gokhan Demir¹, Pasa Yaman², Hayrettin Yuksel³

Abstract

In recent years, the concerns about fossil fuel reserves and global warming by greenhouse gases increase the interests on renewable energy and alternative fuels. Pellets and briquettes, one of the most used biomass form as biofuel, are generally obtained from compressed biological wastes such as saw dust, municipal solid waste, agricultural wastes in lower costs compared to charcoal, firewood, gas, coal etc. conventional fuels to be used in domestic and industrial fields. In an average olive oil production, 35wt% of olive is formed to olive cake as a waste product in continuous-process oil mills (two or three phases). In this work, the studies about production methods, fuel properties and characteristics, and utilization areas of olive cake pellets and briquettes are reviewed. Besides, in respect to the data obtained from Turkish Statistical Institute (2005-15), the annual production of olive, olive oil and olive cake for Turkey was examined. It is observed that in Turkey, a major olive producer in Mediterranean region, annually an average of 378962.5 tons of olive cake can be extracted from 1082750 tons of olive; therefore, a huge energy source exists to able to produce olive cake pellets and briquettes as a biofuel that can result in reduction of dependency on imported energy.

Keywords: *Briquette, Olive cake, Pellet.*

1. INTRODUCTION

Energy has a significant role for social and economic development as well as high standards of living. Energy utilization in developed countries arises at a rate of 1% each year, while in developing countries at a rate of 5% [1]. Hence, much of energy is currently produced and utilized in forms that cannot be sustained; if the technology stays its current level and the global energy demand raise considerably [2]. Yet, oil and natural gas reserves can supply the energy demand at this pace for the next 40 years for oil and 60 years for natural gas [3]. From a totally environmental point of view, the emissions presently produced by the usage of fossil fuels cause crucial environmental problems such as acid rain, the greenhouse effect, and the holes in the ozone layer, that in many situations are irreparable [1,4]. To control the greenhouse gases, harmful exhaust emission gases and particulate matter in atmosphere necessitates possible long period actions for sustainable progress. In this respect, renewable energy sources come out to be one of the most valuable and practical solutions because they are both renewable and sustainable [5]. Moreover, renewable energy generates almost non-existing waste products such as CO₂ and other toxic outputs. Therefore, it has minimum negative effect on the health and/or environment [6].

Renewable energy resources such as hydropower, solar, wind, geothermal and biomass can supply sustainable energy for domestic and urban applications. A transition to renewable energy system is being attractive as production of renewable energy costs become cheaper and as fossil fuel prices is not stable and expensive. It is being obvious that the future of energy sector will be based on renewable energy [7]. Obtaining energy from biomass has an important place in the mankind history. Until the recent past, it was the only resource to obtain energy, and also it is still an energy source for more than half of the world's population for local energy consumption [8]. Biomass consists of organic materials such as wood products, sludge, biogas, biodiesel, ethanol etc. Pellets and briquettes are defined as compressed organic matter or biomass which has mostly 3 to 4 times higher energy density compared to their bulk raw materials [9]. Their higher density and rigid form provide compact storage and easy transportation.

Olive cake is one of the main by-products of olive oil production with olive mill waste water [10]. Olive cakes are generally utilized in animal feeding or organic fertilizing [11]. On the other hand, owing to high amount of the olive cake has a big potential for creating a new renewable energy source on behalf of the environment. One way to recycle the surplus olive cake is to generate thermal energy by combustion. The major problem of recycling the olive cake by burning is that it generates low energy value per unit mass. Moreover, it necessitates large storage capacity [12]. Briquettes and pellets including olive cake, or olive cake blends with other biomass residues are both products deriving from the densification of raw materials, and they are pointed out as value added renewable biomass fuels that have acceptable qualities for energy utilization [13].

In this study, the utilization of olive cake as a raw material for pellet and briquette productions examined. Fuel specifications, production methods and utilization area of pellets and briquettes are summarized. In addition, the

¹Corresponding author: Balıkesir University, Department of Mechanical Engineering, 10100, Balıkesir, Turkey.
veligokhandemir@balikesir.edu.tr

^{2,3}Balıkesir University, Department of Mechanical Engineering, 10100, Balıkesir, Turkey.

amount of olive cake production by years (2000-2015) and the potential for biomass utilization of turkey are defined and evaluated.

2. OVERVIEW OF PELLET AND BRIQUETTE PRODUCTION

2.1 Pellets and Briquettes as Biofuel

In general, biomasses such as sawdust, straw, stalk, rice husk, palm fiber, etc. are not suitable for direct use in heating and burning operations, and they often have large size that makes storage or transportation cost much higher. However, biomass pellet and biomass briquette machines are developed to make the biomass into regular shape solid fuels which are easy to use, convenient to transport and store, and have higher calorific value. Also, biomass pellet and briquettes can be utilized for thermo-chemical operations such as combustion, gasification, pyrolysis or co-firing with coal [14,15].

2.1.1 Pellets

Pellets are cylinder shaped little sticks made from biomass. First, raw materials have to be crumbled for pellet production, and then they have to be densified for a solid condition. Pellets are generally used in pellet stoves for houses, central heating boilers, industrial boilers, or in electric generation plants instead of coal [15]. Pelletization of biomass makes the density of the pellets larger in amount, typically $>600 \text{ kg/m}^3$ and helps to decrease the transportation costs with the suitable material managing and less dust generation [16]. Pellets using for small scale applications have usually 6-8 mm diameter, the ones for large scale applications have a diameter of 10-12 mm. If the pellet's diameter exceeds 25 mm, it is called briquette which has similar outlook to logs made for fireplace but it has better combustion characteristics [17,18]. Pellet and briquette samples are shown in Figure 1.

2.1.2 Briquettes

Briquettes are densified materials produced with large diameter and varied patterns, which are mostly produced by briquette machines. Fundamentally, they are produced for use in industry, on the purpose of heating. It is possible to produce charcoal briquettes for barbecue in screw briquette press, in terms of their ordinary shape and light density. They display a strong durability during combustion and are convenient for transportation and storage [15].

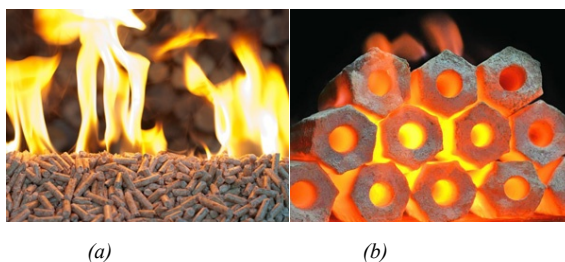

Figure 1.a) Biomass pellets, b) Biomass briquettes [15].

2.1.3 Materials

Raw Materials:

Organic residues or wastes are used as raw materials in production of pellet and briquette as bio-fuel. They are subdivided into primary sources (directly produced materials) and secondary sources (derived from other processes). Generally, pellets and briquettes are produced from sources such as wood species and agricultural residues. The wood species are pine, spruce, beech, oak, poplar, aspen, salix, etc. The agricultural residues are alfalfa, barely, canola, oat, wheat, rice, soy bean, rye, reed canary grass, corn stover, corn cubs, switch grass, big blue stem, sugar cane bagasse, cotton, olive residues, peanut husks etc. [19]. Some of the raw materials are illustrated in Figure 2.



Olive cake

Wood shavings

Tree trimmings

Rice husks

Figure 2. Biomass raw materials

Additives:

An additive agent is utilized to develop characteristics of fuel, obtain lower emission, and make pelletization process profitable. The major drawbacks with agrarian raw materials, in contrast with wooden raw materials, are the higher ash content, the lower ash softening temperature, and the higher risks of corrosion and fouling. Additives are able to neutralize these problems to a certain degree, but this increases the costs and the troubles with high ash content [20-22]. Additive agents may be organic and inorganic. The agents known as organic are heavy crude oil, starch and molasses. Inorganic additives are clay, sodium silicate and glue. Type and amount of the additives play significant role in thermal characteristics of the pellet [23].

2.1.4 Production Processes

Depending on raw materials, different pelleting and briquetting plant processes exist. However, the commonly used whole pelleting and briquetting process is shown in Figure 3 as a flowchart.

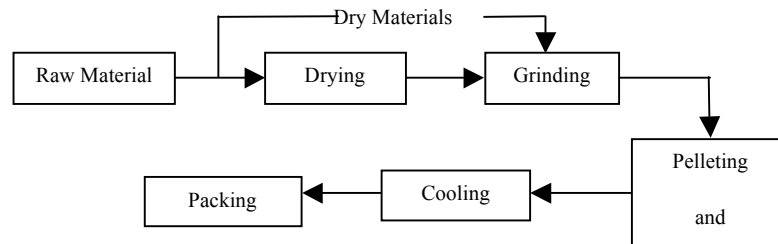

Figure 3. Briquette and pellet production flow chart

Drying:

The pelletization process of biomass in the pellet mill relies on the friction between die and biomass. However, the most important parameter, moisture content of biomass, accomplishes the process successfully. Hence, optimum moisture content has to be attained in terms of pelletization technology and the raw material used. In case of the raw material which will be utilized has the optimum moisture content, the drying is not needed. Dry raw materials can be obtained from operation such as sawdust or wood shavings from a dry sawn timber or with wood dust that is obtained by sanding solid wood. Thereby, this kind of raw materials can be utilized without the need for drying. In case of steam conditioning application, the moisture content of biomass has to be under the optimum value as a result of drying the biomass overmuch. Therefore, moisture content of biomass has to be arranged to the optimum value for efficient pelletization [24].

Grinding:

The dried materials should be resized to desired dimensions for pelleting or briquetting processes. For instance, in typical pellet (6 mm in diameter) production generally used biomass particle size of raw material is 4 mm. The particle size of biomass should be larger in case of densification of pellets with larger diameters. But, the pellet diameter, the pellet mill, or the raw materials do not specify the needed particle size, but also user requirements. For instance, in large electric generation plants that were converted from utilization of coal to pellets, the pellets are generally crushed in pulverizers so that the original size fragments of the pelleted biomass is attained before getting used in the boiler. If the fragments of biomass are larger than required, they will not be combusted efficiently and, thus stack gas emissions and the bottom ash will contain uncombusted charcoal. The smaller the fragments of the biomass material, the more efficient the conversion will be [24].

Pelleting & Briquetting:

The next process after drying and grinding is the densification step. Pelletization basically includes two parts; the densification under pressure of non-rigid material to cut down on its volume and to gather the material thereby the densified biomass endures the compressed condition. The final rigid material is named briquette if, approximately, it has a larger diameter than 30 mm. Smaller dimensions are generally named pellets. If the biomass material is compressed in range of 0.2-5 MPa, then the gap between biomass fragments is reduced. Higher pressure values will destruct the cell walls of cellulose in terms of biomass material variety. High compression values are required for high density pellets. Commonly, a pressure value of 100 MPa or higher is needed for high density pellets. The success of the densification process is related to the applied pressure and biomass material. Final density of a briquette depends on a few major factors such as the structure of material, pellet press and operation conditions as well as minor factors. Yet, the final density of a briquette made from different materials and under high pressure, ranges between 1200-1400 kg m⁻³. Densification of biomass material in hydraulic presses or mechanical piston presses may yield lower densities. The final limit for density of compacted biomass is 1450-1500 kg·m⁻³ [25]. In the industry, many different pellet and briquette machines are utilized in the production. Screw extruders, piston presses and pellet mills are the commonly used ones.

Cooling:

The last step of production is cooling. The biomass is heated by steam or hot water conditioning before pelleting or briquetting and by the frictional forces in the compression chamber. The temperature of the products just right after the densification can change between 80 °C to 130 °C in accordance with the type of mill and operational parameters. Thereby, cooling before storage is necessary. Cooling also enhances mechanical endurance of products and it lowers the moisture content up to 2 wt% [24].

Packing:

Packing is usually the last step in pellet production line. Pellet and briquette packing done by man power decreases labor intensity and efficiency in large scale productions. Therefore, automated packing is suggested for medium and large scale production. The automatic packing machines can pack the products with different weights.

3 OLIVE CAKE BASED PELLETS AND BRIQUETTES

In this section, recent olive oil extraction methods, identification of olive cake, and olive cake based pellet and briquette production are evaluated.

3.1 Olive Oil Production Methods

Olive oil production consists of sequential steps. First, olives are harvested from the olive trees, and then olive fruits are washed and cleaned. After that, olive fruits are crushed and processed in malaxator. After all these processes, olive paste is transferred to a decantor which can be 2-phased or 3-phased [26]. In fact, olive oil extraction consists of two steps: traditional press, utilized for years with only slight adaptations, and two-phased or 3-phased centrifugation. Yet, traditional press is slightly old-fashion process, and the olive oil industry has chosen three-phased or two-phased centrifugation in the last years [27]. Olive oil and olive cake (by-product) together with waste water, and olive oil, olive cake and waste water are extracted from 2-phase system and 3-phase system, respectively.

3.2 Olive Cake (Pomace)

Olive cake is the solid by-product from the extraction of olive oil. It consists of olive pulp, skin, stone and vegetable water, and its appearance is nearly the same to a paste. Such composition is really hard to process and it dries very slowly, hence a lot of problems are experienced in respect of its disposal [28,29]. The processes of obtaining olive oil and olive cake (pomace) are displayed on Figure 4.



Figure 4. The processes of obtaining olive oil and olive cake (pomace) [13].

As a result of high amount of waste that olive oil extraction produces, it would be convenient to find an eco-friendly way of its consumption. Moreover, storage problem exists because of a large depot is needed to store the surplus olive cake. Burning olive cake in a combustion chamber to generate thermal energy would be an approach of its utilization. The easiest way for more effective utilization of the surplus olive cake as an energy source is to take advantage of it by pelleting and briquetting. The major engineering issue of burning olive cake is the low energy amount for one unit mass [12].

3.3 Pellet and Briquette Production

Chemical and combustion characteristics of olive cake for energy application have been inspected, because olive cake was before researched as a possible biofuel. It has been proven that utilization of olive cake as biofuel greatly cuts down the emissions of SO_x (sulfur oxide) which is very high when combusting fuel oil [30] and it is a good energy source for the generation of ecological energy, taking into consideration that all of stack gas emissions were lower than recommended by EU regulations on emissions of pollutants from large burning facilities [31].

Brek et al. [32] stated that bio-pellets attained from olive cake had basically adequate outputs in terms of their quality in contrast with standards for fuel pellets. As a result of high heating values, pellets derived from olive cake introduce good fuel characteristics, which are environmentally advantageous and in the meanwhile, introduces a solution to complication of olive cake usage. Fennir et al. [33] produced pellets and briquettes in Western Mountain region in Libya and showed that olive cake with 15% and 20% moisture content allowed producing durable pellets, but not durable briquettes, which shows, high moisture content is no good for briquette production. In addition, it was indicated that binding agents are required for the compaction of large sized biofuel. Paraffin wax added olive cake briquettes in ratios of 5%, 10% and 15% resulted as durable biofuels. Paraffin wax addition to raw material of briquette increased density and durability. Kowalchuk et al., [34] investigated pellets and briquettes made from different raw materials such as wheat straw, rye straw, maize straw and olive cake. Enthalpy of the combustion, calorific value and combustion value are researched. It was showed that pellets made from olive cake had the highest values in comparison with other biomass raw materials. The final values for a 9.141 g of olive cake pellet are 20.813 MJ·kg⁻¹ for enthalpy of combustion; 19.284 MJ·kg⁻¹ for calorific value and 19.025 MJ·kg⁻¹ for combustion heat.

On the contrary of woody biomass pellets produced from olive cake have higher calorific value. Olive cake pellets have low sulfur content, however higher ash and nitrogen content. Olive cake pellets can be studied to have acceptable properties for thermal usage. But, there are limitations for the content of ash and nitrogen which can lead to troubles throughout burning in the furnace. Physical characteristics of olive cake pellets can be developed by adding woody biomass [9]. Miranda et al., [35] examined pelletization of olive cake (OC) and Pyrenean oak residue (POR) in different ratios such as 100% OC; 75% OC and 25% POR; 50% OC and 50% POR; 25% OC and 75% POR; 100% POR. The high heating values of the pellets are 5262.48 kcal·kg⁻¹, 5042.86 kcal·kg⁻¹, 4746.92 kcal·kg⁻¹, 4595.55 kcal·kg⁻¹, 4568.69 kcal·kg⁻¹, respectively. The study proved that pure olive cake pellets had higher heating value in contrast to other mixtures. Besides, low sulfur values (<0.1%) for olive cake pellet are promising in terms of environment and future. Other results showed that nitrogen oxide value which is almost 2% may cause ecological problems; thereby it was lowered by blending with different raw materials such as Pyrenean oak residue. Moreover, pure olive cake pellets had lower durability in contrast with other blended pellets however, it is above 90%. Barbanera et al., [36] researched pellets derived from olive cake (OC) and olive tree pruning (OTP). Olive cake was obtained from two-phased and three-phased decanters. The researchers made combinations of 75% OTP and 25% OC; 50% OTP and 50% OC; 25% OTP and 75% OC. The biomass samples compacted using a laboratory pellet mill. The results showed that OTP addition to olive cake pellets allowed the chemical characteristics of bio-pellets fit to standards regarding mechanical durability, nitrogen and copper content. The net calorific values of produced pellets are appropriate to the EN 17225-6 standard, which recommends a solid biofuel should be ≥ 14.4 MJ·kg⁻¹. Besides, bulk density enhanced allowing a reduction of transport and storage cost.

4 POTENTIAL OF TURKEY

Turkey's foreign energy imports constitute approximately 70% of its total energy consumption, and the energy demand is increasing related to population growth [37]. Therefore, national renewable energy sources have become more important for Turkey, fossil fuel-poor country. As it was mentioned, olive cake is a suitable raw material to produce biomass pellet and briquette fuels. In this section, Turkey's potential of olive oil, olive cake and olive cake based pellet and briquette production are determined and evaluated.

4.1. Olive Production of Turkey

According to the report of International Olive Oil Council (November 2015), Turkey (5.7%) is the biggest olive oil producer after EU (69.9%) and Tunisia (6.2%) in the world [38]. There are nearly 700 varieties of olives grown throughout the world, with 50 over 86 of them in Turkey alone. Turkey exports olive oil to more than 90 countries. In Turkey, over 113 million olive trees for oil are located in 6·10⁹ m²; 55 million olive trees for tables are located in 2.2·10⁹ m² by 2014. 73% of areas used in Turkey for olive trees are for oil only. As a result of increase in the number of bearing olive trees used for oil for the last 7 years, production of olive for oil went up from 950000 tons to 1330000 tons [39].

As reported by the Turkish Statistical Institute (TSI) [40], between the years of 2005 and 2015, annually an average of 1538773 tons of olive was produced, for both tables and oil. The oil production increased 31000 tons in the last decade. Almost 70% of olive production has been utilized for oil extraction. 112000 tons of olive oil (OO) in 2005, 143000 tons of OO in 2015 and 147700 tons of OO averagely in the last decade were extracted [40]. It is reported that [41], approximately 35% of olive is converted to olive cake as a by-product at the end of the extraction process. Thereby, it can be assumed that annually 280000, 455000, and 378962.5 tons of olive cake was generated in 2005,

2015 and an average of the last decade (2005-2015), respectively, in Turkey. Total olive production, olive production for oil, and olive cake potential of Turkey are shown in Figure 5 as a graph.

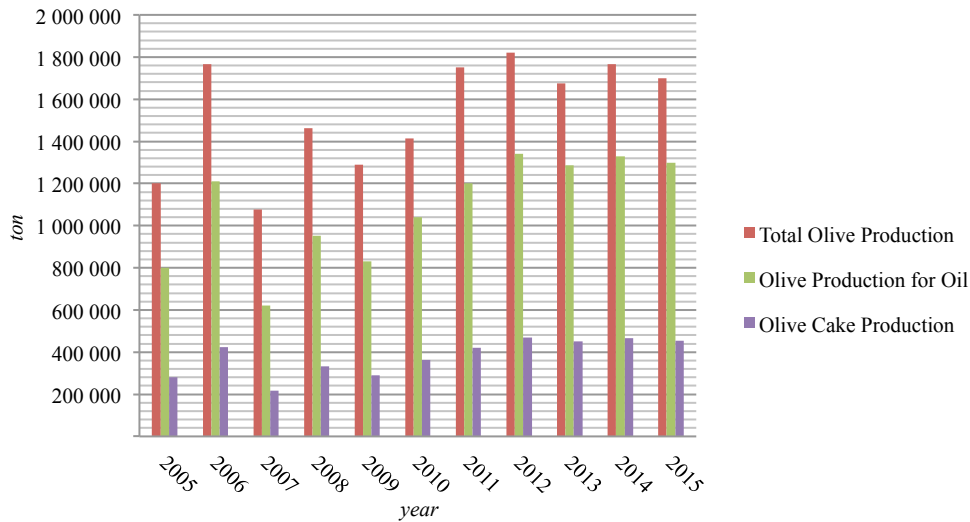

Figure 5. Annual Production ratios of Olive, Olive Oil and Olive Cake in Turkey

4.2. Bio-pellet and Briquette Production Potential of Turkey

According to the World Bank's data from 2005 to 2015 [37], energy consumption per capita increased 24% (0.29954 tons of oil equivalent (toe)) related with developments of economic condition and technological use of Turkey. TSI reported that population of Turkey increased from 68861000 to 78152000 at the range of 2005-2015. In this section, in respect with World Bank and TSI data, the energy demand of Turkey for the last decade and the average of last decade were calculated. Hereby, the energy demand of Turkey was found out 85453057.95 toe by 2005, and it increased to 120392374.48 toe by 2015. It is clear that, total energy consumption of Turkey was increased 40.89% in ten years, and the average energy demand of the last decade was obtained as 107032518.9 toe. In 2005; the total energy consumption for space heating was declared from TSI [40] as 1533519 toe, and it is approximately equal to 2.98% of overall energy consumption of Turkey. From 2005 to present, TSI has not investigated energy consumption amounts for space heating; therefore the percentage ratio of space heating to whole energy consumption of Turkey was assumed constant (2.98%). Consequently, increase of the energy consumption for space heating was found as 633543 toe.

In this work, it was assumed that all the olive cake potential of Turkey was utilized as olive cake based pellets and briquettes. It is stated [35] that olive cake pellets have approximately 5262.48 kcal·kg⁻¹ high heating value (5.26·10⁻⁴ toe per kg). Conforming to the fuel property of olive cake fuels, total energy generation potential of Turkey from olive cake based pellets and briquettes was calculated as 147280 toe for 2005, 239330 toe for 2015, and 199334.36 toe for the average of the last decade. According to the calculations, olive cake based pellets and briquettes can supply 10.29% of energy consumption for space heating and 0.18% of whole energy demand of Turkey for the last decade results.

In Table 1; the population, energy consumption per capita (ECPC), total energy consumption (TEC), energy consumption for space heating (ECFSH), olive cake pellets and briquettes potential (OCP), olive cake potential's percentage in space heating (OCPSH) and olive cake potential's percentage in total energy consumption (OCPTEC) of Turkey between 2005-2015 are shown.

Table 1. Some specific data about Turkey's energy consumption and generation

Year	Population	ECPC (toe)	TEC (toe)	ECFSH (toe)	OCP (toe)	OCP SH	OCPTE C
2005	68861000	1.24095	85453057.95	1533519	147280	9.60%	0.17%
2006	69730000	1.35583	94542025.9	1701756.47	222945.1	13.10%	0.24%
2007	70586000	1.43854	101540784.44	1827734.12	114228.34	6.25%	0.11%
2008	71517000	1.40326	100356945.42	1806425.02	175289.90	9.70%	0.17%
2009	72561000	1.37229	99574734.69	1792345.22	152921	8.53%	0.15%
2010	73723000	1.45584	107328892.32	1931920.06	191464	9.91%	0.18%
2011	74724000	1.52635	114054977.4	2052989.59	220920	10.76%	0.19%
2012	75627000	1.56184	118117273.68	2126110.93	246694	11.60%	0.21%
2013	76482000	1.52820	116879792.4	2103836.26	236752.6	11.25%	0.20%
2014	77324000	1.54049	119116848.76	2144103.28	244853	11.42%	0.21%
2015	78152000	1.54049*	120392374.48	2167062.74	239330	11.04%	0.20%
Avg.	73571545	1.45128	107032518.9	1926163.88	199334.36	10.29%	0.18%

*The World Bank provided data until 2014, given data for 2014 was presumed for 2015.

It is clearly seen that Turkey having quite limited energy sources has a dramatically big biomass potential by olive cake production. Hence, production and utilization of olive cake based densified biomass fuels should be supported by the government to decrease energy import ratios. On the other hand, in order to convert olive cakes to value added biofuels, production plants are needed to meet sector's demand. These facilities can provide employment for many people and promote local areas to be developed.

CONCLUSION

Turkey is one of the biggest olive producer in the world where 70% of all harvested olives are turned into oil. Olive cake is a by-product of the olive oil production process and it is an acceptable quality agricultural biomass. In Turkey, large quantities of olive cake are mostly underutilized, and it is feasible to make olive cake into fuel pellets and briquettes. In this study, according to the olive production reports, the potential of olive cake based pellet and briquette production, and the generable energy derived from them are calculated. In respect to the average results of the last decade, it is found that these biofuel products are significant national renewable energy sources for energy generation, and they have big potential corresponding to 10.29% of energy consumption for space heating, and 0.18% of whole energy demand of Turkey. Two main conclusions can be resulted with this study:

- Utilization of olive cake based biofuels would decrease energy import,
- Production of these domestic biofuels will increase employment and agriculture development.

REFERENCES

- [1]. T. Muneer, M. Asif, S. Munawwar, "Sustainable production of solar energy with particular reference to the Indian economy," *Renewable and Sustainable Energy Reviews*, vol. 9, pp. 444-473, 2005.
- [2]. K. Kaygusuz, A. Sari, "Renewable energy potential and utilization in Turkey," *Energy Conversion and Management*, vol. 44, pp. 459-478, 2003.
- [3]. A. Garcia-Maraver, M. Zamorano, A. Ramos-Ridao, L.F. Diaz, "Analysis of olive grove residual biomass potential for electric and thermal energy generation in Andalusia (Spain)," *Renewable and Sustainable Energy Reviews*, vol. 16, pp. 745-751, 2012.
- [4]. M.A. Rosen, "Assessing energy technologies and environmental impacts with the principles of thermodynamics," *Applied Energy*, vol. 72, pp. 427-441, 2002.
- [5]. I. Dincer, "Renewable energy and sustainable development: A Crucial review," *Renewable and Sustainable Energy Reviews*, vol. 4, pp.157-175, 2000.

- [6]. M. Hoogwijk, A. Faaij, R. Van den Broek, G. Berndes, D. Gielen, W. Turkenburg, "Exploration of the ranges of the global potential of biomass for energy," *Biomass and Bioenergy*, vol. 25, pp. 119-133, 2003.
- [7]. A. V. Herzog, T. E. Lipman, J. L. Edwards, D. M. Kammen, "Renewable Energy: A Viable Choice, *Environment*, vol. 43, No. 10, 2001.
- [8]. N. Sriram, M. Shahidehpour, "Renewable Biomass Energy," in *IEEE Power Engineering Society General Meeting*, vol. 1, pp. 612-617, 2005.
- [9]. Wood Pellets and Briquettes Data Sheet No.1, UK Forestry Commission, Biomass Energy Centre, 2007.
- [10]. G. Brunetti, C. Plaza, N. Senesi, (2005). Olive pomace amendment in Mediterranean conditions: effect on soil and humic acid properties and wheat (*Triticum turgidum* L.) yield. *Journal of Agricultural and Food Chemistry*, vol. 53, Issue 17, pp. 6730-6737, 2005.
- [11]. (2016) The Solvent Extractors' Association of India website. [Online]. Available: <http://www.seaofindia.com/>
- [12]. T. Brlek, L. Pezo, N. Voca, T. Kricka, D. Vukmirovic, R. Colovic, M. Bodroza-Solarov, "Chemometric approach for assessing the quality of olive cake pellets," *Fuel Processing Technology*, vol. 116, pp. 250-256, 2013.
- [13]. Amisy Machinery Co. Ltd. (2016) Wood Pellet Mill webpage. [Online]. Available: http://www.wood-pellet-mill.com/uploads/soft/201505/3_07094802.pdf
- [14]. N. Kaliyan, R. V. Morey, "Densification characteristics of corn stover and switch grass," *Transactions of the ASABE*, vol. 52, Issue 3, pp. 907-920, 2009.
- [15]. (2016) Gemco Energy website. [Online]. Available: <http://www.gemco-energy.com/biomass-pellets-and-briquettes.html>
- [16]. P. Gilbert, C. Ryu, V. Sharifi, J. Swithenbank, "Effect of process parameters on pelletization of herbaceous crops," *Fuel*, vol. 88, pp. 1491-1497, 2009.
- [17]. UK Forestry Commission, Biomass Energy Centre, Information Sheet No.1, Wood Pellets and Briquettes, 2007, <http://www.biomassenergycentre.org.uk/>
- [18]. C. Gokcol, B. Dursun, B. Alboyaci, E. Sunan, "Importance of biomass energy as alternative to other sources in Turkey," *Energy Policy*, vol. 37, pp. 424-431, 2009.
- [19]. Stelte, "Fuel Pellets from Biomass. Processing, Bonding, Raw Materials," PhD Thesis, Danish National Laboratory for Sustainable Energy, Technical University of Denmark, Dec. 2011.
- [20]. B. M. Jenkins, L. L. Baxter, T. R. Miles Jr, T. R. Miles, "Combustion properties of biomass," *Fuel Processing Technology*, vol. 54, pp. 17-46, 1998.
- [21]. L. Nikolaisen, T. Nørgaard Jensen, K. Hjulær, J. Busk, H. Junker, B. Sander, "Quality characteristics of biofuel pellets," Danish Technological Institute, Aarhus, Denmark, 2002.
- [22]. I. Obernberger, G. Thek, "Physical characterisation and chemical composition of densified biomass fuels with regard to their combustion behavior," *Biomass Bioenergy*, vol. 27, pp. 653-669, 2004.
- [23]. N. E. Altun, C. Hicyilmaz, A. S. Bağcı, "Combustion Characteristics of Coal Briquettes. 1. Thermal Features," *Energy & Fuels*, vol. 17, pp. 1266-1276, 2003.
- [24]. G. Thek and I. Obernberger, *The pellet handbook: the production and thermal utilization of biomass pellets*, Routledge, 2012.
- [25]. (2016) Visviva Renewable Energy webpage. [Online]. Available: http://www.visviva.com/various_briquetting_and_pelletizing_technologies.html
- [26]. J. M. Romero-Garcia, L. Nino, C. Martinez-Patino, C. Alvarez, E. Castro, M. J. Negro, "Biorefinery Based on Olive Biomass. State of the Art and Future Trends," *Bioresource Technology*, vol. 159, pp. 421-432, 2014.
- [27]. A. Roig, M.L. Cayuela, M.A. Sanchez-Monedero, "An overview on olive mill wastes and their valorisation methods," *Waste Management*, vol. 26, pp. 960-969, 2006.
- [28]. P.A. Fokaides, K. Tsiftes, "Utilisation of Olive Husk in energy sector in Cyprus," *Renewable Energy Sources & Energy Efficiency*, pp. 28-30, 2007.
- [29]. E. Molina-Alcaide, D. R. Yanez-Ruiz, "Potential use of olive by-products in ruminant feeding: A review," *Animal Feed Science and Technology*, vol. 147, Issues 1-3, pp. 247-264, 2008.
- [30]. R. Borja, F. Raposo, B. Rincon, "Treatment technologies of liquid and solid wastes from two-phase olive oil mills," *Grasas y Aceites*, vol. 51, Issue 1, pp. 32-46, 2006.
- [31]. H. Topal, A.T. Atımtay, A. Durmaz, "Olive cake combustion in a circulating fluidized bed," *Fuel*, vol. 82, pp. 1049-1056, 2003.
- [32]. T. Brlek, N. Voca, T. Kricka, J. Levic, D. Vukmirovic, R. Colovic, "Quality of Pelleted Olive Cake for Energy Generation," *Agriculturae Conspectus Scientificus*, vol. 77, No. 1, pp. 31-35, 2012.
- [33]. M. A. Fennir, V. G. S. Raghavan, Y. Gariépy, S. Sotocinal, "Strength of pellets and briquettes made from Libyan olive oil solid residues," *International Conference on Advances in Agricultural, Biological and Environmental Sciences, 2014, Dubai*.
- [34]. J. Kowalczyk, J. Zarajczyk, P. Sobczak, J. Mazur, S. Rudy, D. Cychan, M. Winiarczyk, K. Jadwisienczak, K. Zalewka, "The Usefulness of briquettes and pellets from selected plant materials for energy purposes," *TEKA Commission of Motorization and Energetics in Agriculture*, vol. 12, No. 2, pp. 311-313, 2012.
- [35]. T. Miranda, J. I. Arranz, I. Montero, S. Roman, C. V. Rojas, S. Nogales, "Characterization and combustion of olive pomace and forest residue pellets," *Fuel Processing Technology*, vol. 103, pp. 91-96, 2012.
- [36]. M. Barbanera, E. Lascaro, V. Stanzione, A. Esposito, R. Altieri, M. Bufacchi, "Characterization of pellets from mixing olive pomace and olive tree pruning," *Renewable Energy*, vol. 88, pp. 185-191, 2016.
- [37]. (2016) The World Bank website. [Online]. Available: <http://worldbank.org/>
- [38]. (2016) International Olive Council website. [Online]. Available: <http://www.internationaloliveoil.org/>
- [39]. (2016) Gemco Energy website. [Online]. Available: <http://www.pelletmillsolution.com/faqs/dies-for-wood-pellet-making-machine.html>
- [40]. (2016) Turkish Statistical Institute website. [Online]. <http://www.tuik.gov.tr>
- [41]. C. Nasopoulou, I. Zabetakis, "Agricultural and Aquacultural Potential of Olive Pomace: A review," *Journal of Agricultural Science*, vol. 5, No. 7, 2013.

Zooplankton Studies in the Boka Kotorska Bay (Southern Adriatic) Larvae

¹Vera Vukanic, Murat Sezgin ²

Abstract

Data presented in this paper are results of a study performed in period January-December 2010 in Boka Kotorska Bay. During that period, hydrographic parameters and zooplankton were intensively sampled at seven fixed stations. Three of these stations were placed in the shallow part of the Bay near the shellfish farm, and four in the middle parts of each smaller bay that are part of Bokokotorski Bay. The program and locality of stations in the study were purposefully chosen to enable a thorough study, yielding new data on hydrographic conditions and zooplankton biocenosis. The results are based on the yearly cycle of monthly series of zooplankton sampling, as well as the data on physical-chemical conditions of the sea. Boka Kotorska Bay is a relatively closed part of the sea, with specific features such as the pronounced influence of surrounding land and an immense influx of fresh water. The impact of the open sea is strongest in Hercegovski Bay, while toward the inner waters of Boka Kotorska Bay it gradually decreases. The special ecological conditions in Boka Kotorska Bay are reflected on taxonomic structure, distribution and abundance, both of individual species and the zooplankton as a whole. Results of this research include the biological monitoring at the Bay, based on following certain species within the zooplankton and the functional attributes of the ecosystem, plankton diversity and communities of zooplankton species. The combination of collected data were used to define the ecosystem of the Bay and to determine the degree of anthropogenic degradation within it. In this paper we present the hydrographic data of Boka Kotorska Bay, together with data on presence, abundance and distribution of the larvae: decapoda, ophiurida, echinida, cirripedia, bivalvia, bipinnaria, tornaria, auricularia, mitraria, nauplius larvae and pisces larvae.

Key words: Adriatic, Boka Kotorska Bay, zooplankton, larvae

1. INTRODUCTION

Bay of Boka Kotorska represents a relatively confined part of the sea, which is made of 4 bays with their specificities, such as a distinct impact of washing from the surrounding land, intake of fresh waters during the colder period of the year and the influence of open sea, which is the most pronounced in the Bay of Hercegovi. Ecological specificities of the Bay of Boka Kotorska reflect on taxonomic composition and distribution, both of the individual species and of the overall zooplankton. Specific ecological conditions and geographic situation of the Bay of Boka Kotorska make it an eutrophic biotope the biota of which experiences the impact of fresh waters intake from the land and streaming from the open sea. In this paper we present data on composition of meroplanktonic community and immanent larvae. Alongside with the investigation of zooplankton, physical and chemical parameters of the environment have been measured and analysed. The paper comprises the investigations of meroplankton in all the bays of the Bay of Boka Kotorska (Bay of Kotor, Bay of Risan, Bay of Tivat and Bay of Hercegovi) in annual cycle of intense investigations, as well as of shallow habitats convenient for mariculture. Former data on zooplankton for the Bay of Boka Kotorska are given in numerous papers which bring only scarce data on larvae. Data on fish roe and larvae for the Bay of Boka Kotorska are given by Gamulin (1954) and Merker, K. (1971). Zooplankton of the Bay of Boka Kotorska is a typical meroplanktonic community rich in various larval forms of pelagic and benthos organisms.

The objective of these investigations was to obtain an insight into the composition of meroplanktonic community and its place in zooplanktonic biocenose of the Bay of Boka Kotorska. The results of these investigations are relevant for defining, valorisation and protection of zooplanktonic biocenose biodiversity in littoral waters of South Adriatic.

2. MATERIALS AND METHODS

Our observations were based on the analysis of zooplankton samples collected monthly during 2010 on three shallow stations near the seafood farming areas (P-IBM, P-M, P-O) and 4 stations in the middle of each bay within Bay of Boka Kotorska: Bay of Kotor (P1), Bay of Risan (P2), Bay of Tivat (P3) and Bay of Hercegovi (P4). Zooplankton was collected with Nansen net (100 and 150 microns). In the same time, other factors were measured: T°C, Sal‰, pH, O₂, transparency by Secchi plate, color of the sea with Forel scale I-XXI.

¹Corresponding autor: Department of Biological Sciences, Faculty of Biology, State University Novi Pazar, Serbia
veravukanic@yahoo.com; vvukanic@np.ac.rs¹

²Sinop University Faculty of Fisheries; Marine Biology and Ecology Department, TR5700 Sinop, Turkey biologistms@gmail.com

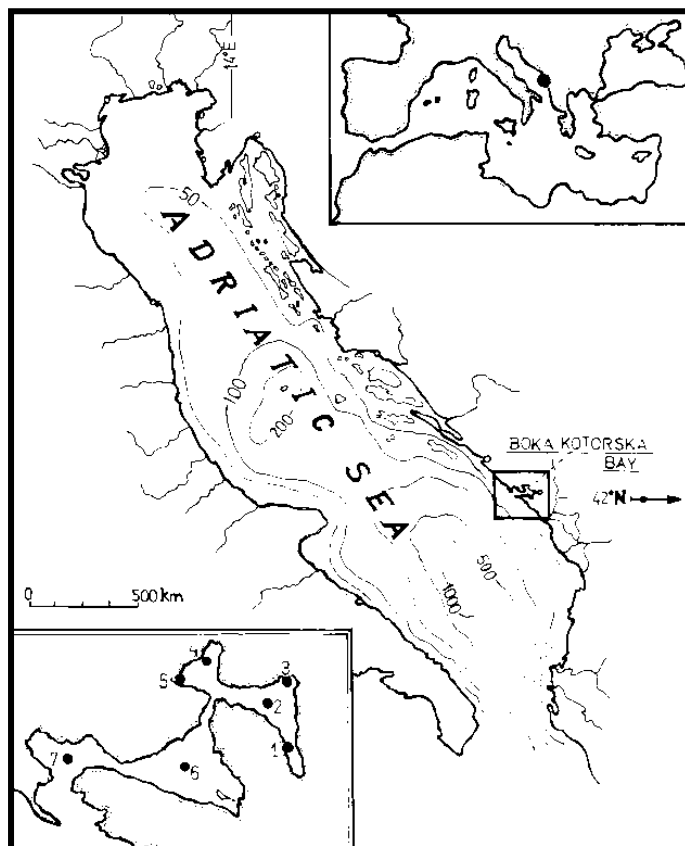

Figure 1. Map of sampling area in southern Adriatic [1: (P-IBM); 2: (P₁-K); 3: (P-O); 4: (P₂-R); 5: (P-M); 6: (P₃-T); 7: (P₄-HN)]

3. RESULTS AND DISCUSSION

Hydro-meteorological conditions of this area make an impact on anomalies in oscillation of ecological conditions in the Bay of Boka Kotorska. Temperature oscillations are clearly expressed. Minimal temperature was recorded in January (8.20°C) at the site P-IBM in the Bay of Kotor, whereas the maximal one was in July (28.60°C) also at the site P-IBM in the Bay of Kotor. According to former data the maximum in the surface layer of the sea totalled 29.00°C (Vukanic, D. *et al.* 1979).

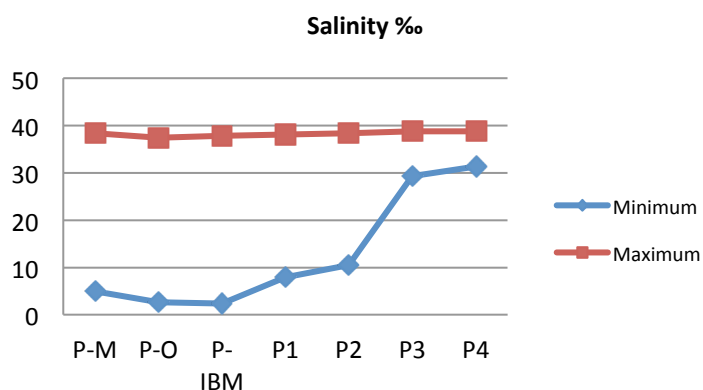

Figure 2. Variation of salinity at stations during 2010.

Salinity has a severely high variation in the surface layer of the sea, owing to the intake of fresh waters and precipitation in winter months. Maximal salinity totalled in March 37.80‰ at the site P-IBM, on depth of 10 m, in the Bay of Kotor, minimal one being recorded in November 2.70‰ at the site P-O, in surficial layer in the Bay of Kotor.

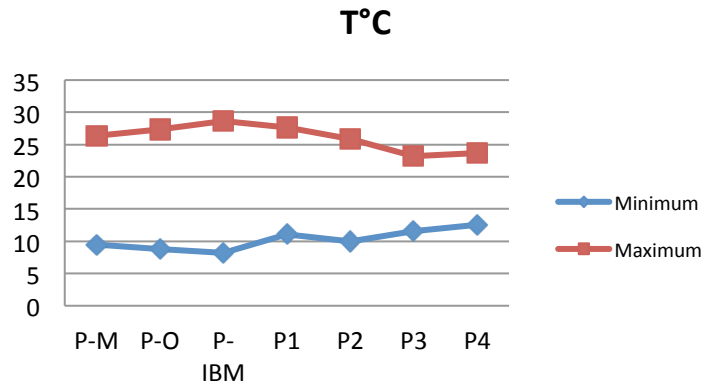

Figure 3. Variation of temperature at stations during 2010.

Our detailed investigations of network zooplankton also include the larvae from various groups of marine organisms thereof we present data for the Bay of Boka Kotorska. Their percentual participation as related to the total zooplankton rated for the Bay of Kotor 1%, Bay of Risan 25%, Bay of Tivat 4.99% and Bay of Hercegovi 6.79%.

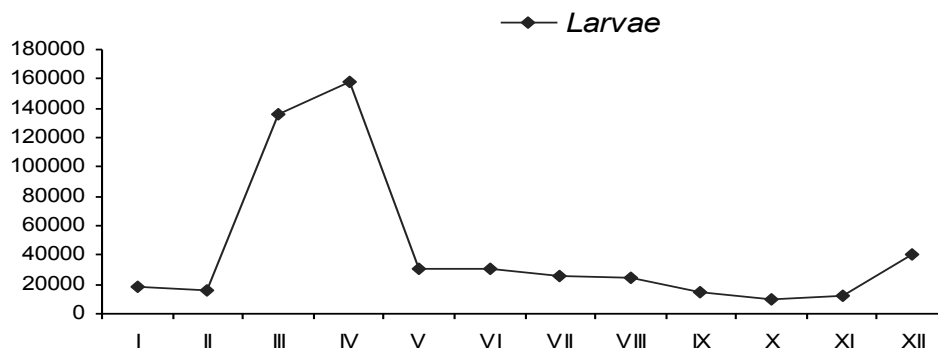

Figure 4. Quantitative fluctuation of the Larvae during the study

Nauplius stadia of copepods are organisms that are more or less segmented, slightly chitinous which in meroplankton make a dominant group of larvae. Here we present the data about their abundance and distribution in the Bay. They were numerously presented at all the sites with markedly increased abundance by the end of Winter and beginning of Spring. Their percentual participation as related to other larvae in plankton rated 46.7% for the Bay of Kotor, 82.6% for the Bay of Risan, 28.48% for Bay of Tivat and 22.7% for the Bay of Hercegovi.

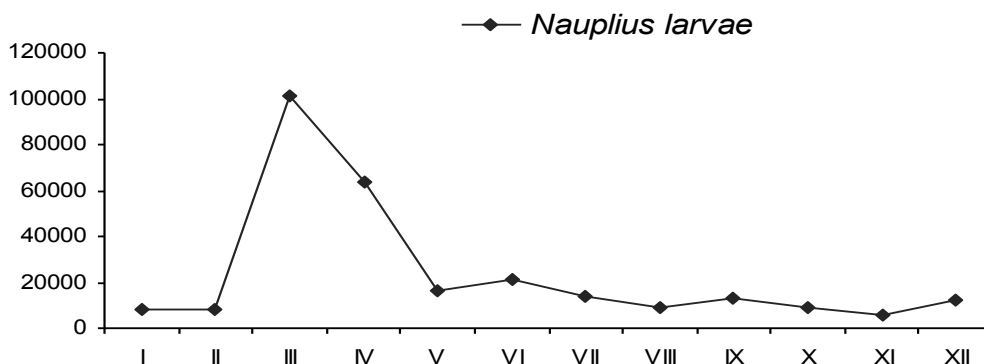

Figure 5. Quantitative fluctuation of the Nauplius larvae during the study

Larvae of crustacea compose a significant part of meroplankton community. Cirripedia larvae also have a relatively numerous participation in that community, and we present data on their abundance and distribution in the Bay. Their percentual participation as related to other larvae in plankton ranged for the Bay of Kotor 4.62%, the Bay of Risan 0.17%, Bay of Tivat 10.53% and Bay of Herceg Novi 1.54%.

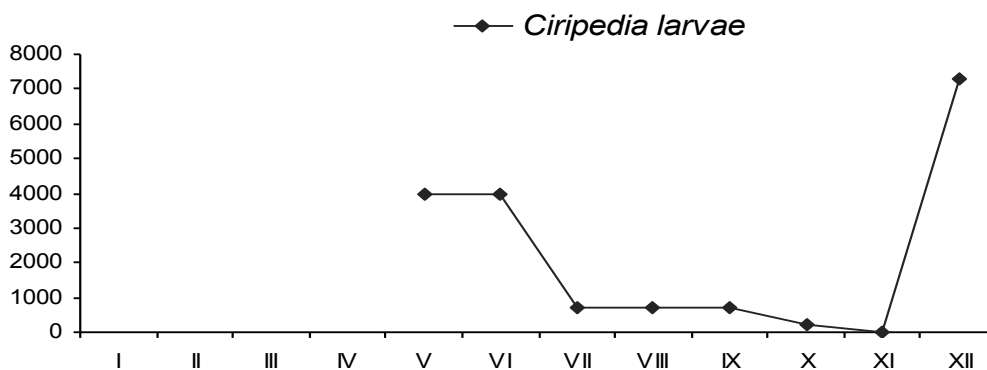

Figure 6. Quantitative fluctuation of the Cirripedia larvae during the study

Larvae of various types of decapods are present at all sites throughout the entire year, they were less numerous at deeper sites, and most numerous at the shallow ones along the shore. Data on abundance and distribution of decapod larvae in Adriatic are very scarce. The first qualitative-quantitative data are given by Kurian (1956), Vučetić (1957), Lučić (1985, 1998), Lučić & Bender-Pojatina (1995). Štević (1990) cites that the fauna of decapod crustaceans of Adriatic Sea is very rich and versatile, and it is frequently difficult to differ some larval stadia more precisely from the category of the genus or the family, what is confirmed by the most recent investigations of Adriatic Sea (Gullèen & Gras, 1995). Their percentual participation as related to other larvae in the plankton ranged for the Bay of Kotor 6.11%, Bay of Risan 0.35%, Bay of Tivat 11.04% and Bay of Herceg Novi 5.96%.

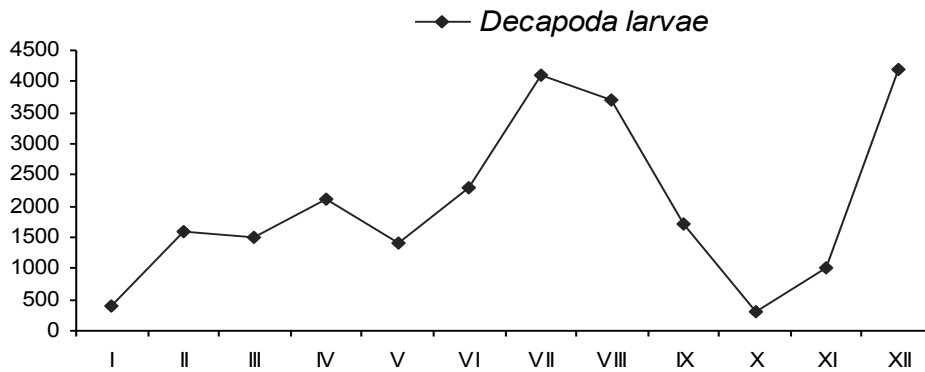

Figure 7. Quantitative fluctuation of the Decapoda larvae during the study

Larvae of Ophiuridae are very common in plankton, they occur throughout the entire year, most frequently larvae are from the genera: *Ophiothrix*, *Ophioglypha*, *Amphiura* etc. (Treguboff, G. & Rose, M., 1957). We present the first data for the Bay of Boka Kotorska about the occurrence, abundance and distribution of Ophiurida larvae. Their percentual participation as related to other larvae in plankton ranged for the Bay of Kotor 0.18%, Bay of Risan 0.29%, Bay of Tivat 4.01% and Bay of Herceg Novi 6.5%.

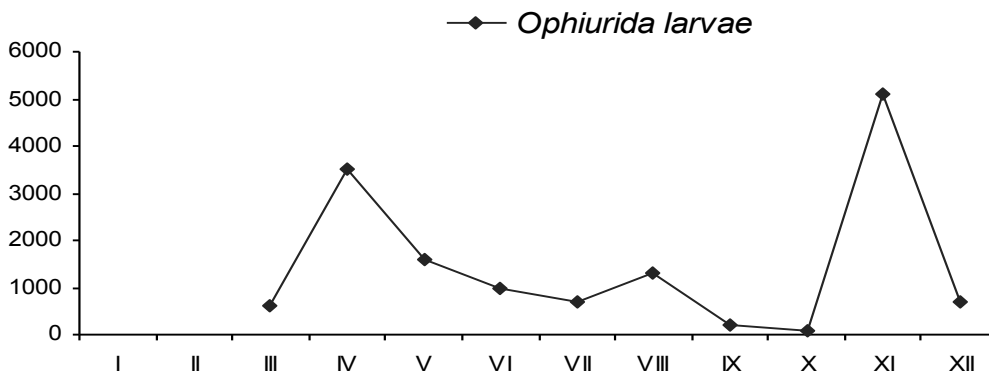

Figure 8. Quantitative fluctuation of the Ophiurida larvae during the study

We present the first data from the annual cycle of research on oscillations and abundance of juvenile *Mytilus galloprovincialis* L. in the Bay of Boka Kotorska. In our data for shallow habitats (P-IBM, P-O, P-M) in immediate proximity of culturing spot there occur markedly high values for abundance of juvenile *Mytilus galloprovincialis* L. from the end of February until the end of April. We record a maximum of numerosity at the end of April with percentual participation as related to the total zooplankton of 9.40% by the Institute, 12.20% by Orahovac and 5.55% by Morinj. In November, December and January we did not record any specimen, probably because of heavy rains and large intake of fresh waters into the Bay of Boka Kotorska what caused their going off and taking away from these habitats by the streams. We recorded high values for abundance of juvenile *Mytilus galloprovincialis* L. from the end of March to the end of April and at the central sites of all four bays. Maximal abundance at these sites also was found at the end of April, and their percentual participation as compared to the total zooplankton ranged 5.44% in the Bay of Kotor, 18.66% in the Bay of Risan, 3.85% in the Bay of Tivat, and 6.21% in the Bay of Herceg Novi. Increased values of number of individuals of this form were also recorded in July in the Bay of Herceg Novi (50300 ind/m²) and their percentual participation as related to the total zooplankton was 16.79%. The increase of abundance in November and December was stated in outer part of the Bay of Boka Kotorska. During the Autumn spawning (September - October) the Bay experiences the occurrence of very strong exit streams (3cm/sec) which take away a mass of larvae and juvenile specimens towards the Bay of Herceg Novi and the open sea; thus in the Bay of Herceg Novi we record average annual value of percentual participation in zooplankton of 61.89% of these forms. Percentual participation as

related to other larvae in plankton ranged for the Bay of Kotor 39.07%, Bay of Risan 15.8%, Bay of Tivat 40.9% and Bay of Herceg Novi 61.89%.

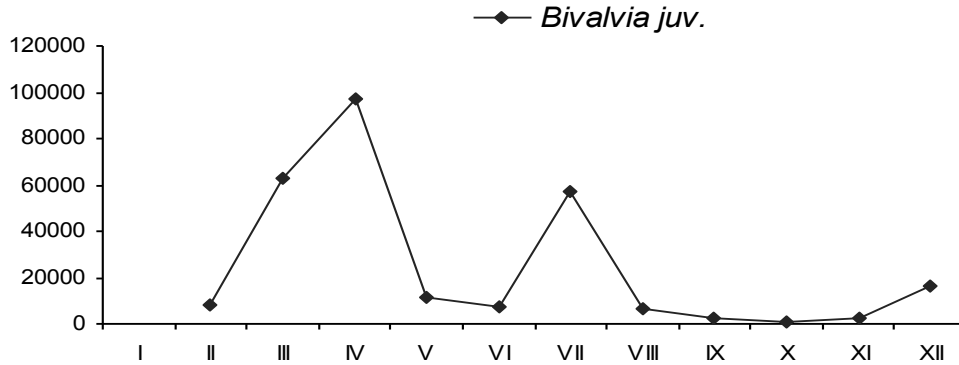

Figure 9. Quantitative fluctuation of the *Bivalvia* larvae during the study

Data on fish roe and larvae for the Bay of Boka Kotorska are given by Gamulin (1954) and Merker, K. (1971). They cite that spawning in the Bay is very poor and that it starts in October at average temperature of 19.40°C, and ends in March at average temperature of 13.85°C. Our data which are from the samples taken by a dense net (150µm) indicate poorness in number of roe and larvae with maximal abundance in August and lower one in April. Merker, K. (1971) cites that it is possible to assume that in this small place with low depth one cannot expect more numerous population of adult pilchard. Percentual participation as related to other larvae in the plankton ranged for the Bay of Kotor 0.55%, Bay of Risan 0.001%, Bay of Tivat 0.12% and Bay of Herceg Novi 0.23%.

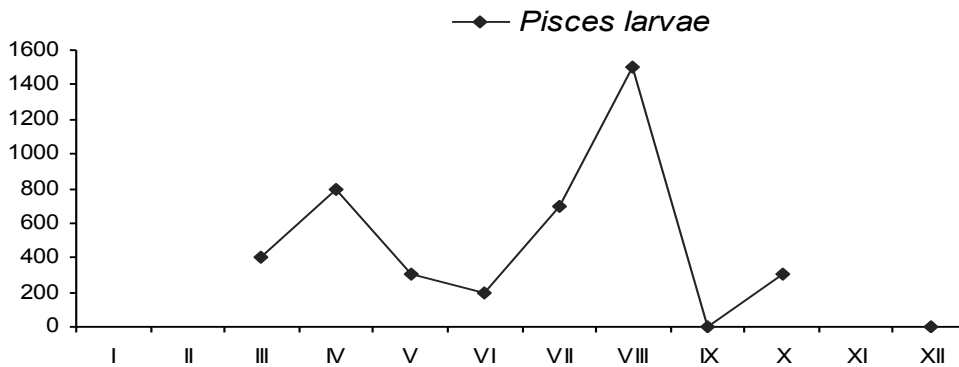

Figure 10. Quantitative fluctuation of the *Pisces* larvae during the study

Larvae of polychaeta occur almost continuously at all sites, somewhat more numerous during the Autumn and Winter. Percentual participation as related to other larvae in plankton ranged for the Bay of Kotor 10.37%, Bay of Risan 0.74%, Bay of Tivat 3.63% and Bay of Herceg Novi 5.49%.

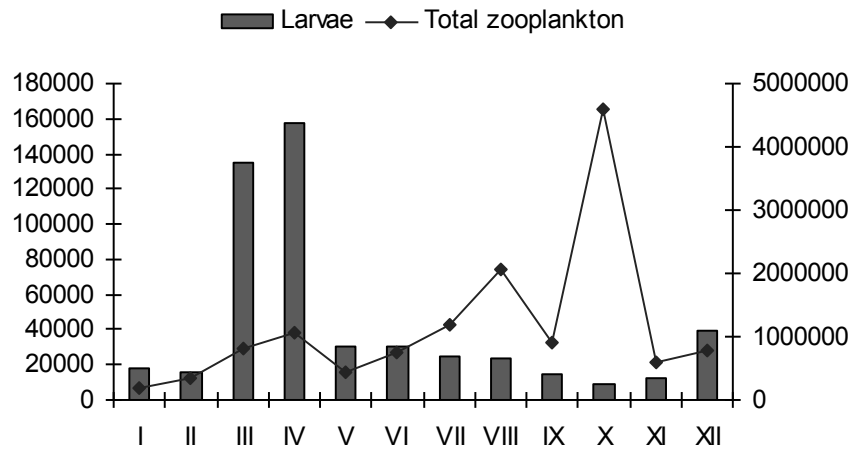

Figure 11. Fluctuations in abundance of zooplankton and larvae during the studied year in Bay of Boka Kotorska

Table 1. Larvae and pisces eggs found in investigation station in Bay of Boka Kotorska during 2010.

Stations	P-IBM	P-O	P-M	P ₁ -K	P ₂ -R	P ₃ -T	P ₄ -HN
Larvae							
Decapoda l.	+	+	+	+	+	+	+
Ophiurida l.	+	+	+	+	+	+	+
Echinida l.	+	+	+	+	+	+	+
Cirripedia l.	+	+	+	+	+	+	+
Bivalvia juv.	+	+	+	+	+	+	+
Bipinnaria l.		+	+				
Tornaria l.			+	+			+
Auricularia l.				+	+	+	+
Mitraria l.						+	
Nauplius l.	+	+	+	+	+	+	+
Pisces l.	+	+		+		+	
Pisces ova	+	+		+	+	+	+
Total	8	9	8	10	8	10	9

4. CONCLUSIONS

Waters of the Bay of Boka Kotorska have very marked oscillations of hydrographic properties and there are significant differences among the individual bays. In thermic respect the Bay of Boka Kotorska does not represent a homogenous area. The most marked oscillations are in surficial strata. Temperature maximum usually occurs in July or August, minimum in January or February. Data on temperature, salinity, saturation by oxygen which always ranged above 100%, pH, color of the sea and transparency have confirmed that the Bay of Boka Kotorska is markedly eutrophic area.

Abundant presence of larvae of various pelagic and benthos species of animals in plankton of the Bay of Boka Kotorska defines this community as a meroplanktonic one. The biomass of larvae has always been lower at the sites by the coast, with the exception of juvenile bivalvia and crustacea larvae, and more abundant in the middle of the bay. From April to June there was stated an increased abundance of juvenile Bivalvia of species *Mytilus galloprovincialis* L.. We recorded the highest percentual participation of planktonic larvae in the Bay of Risan.

REFERENCES

- [1] .Gamulin, T., Mriješćenje i mrijestilišta sardele (*Sardina pilchardus* Walb.) u Jadranu 1947-50. Izvješća (biol. eksp. "Hvar" 1948-1949) IV(6) Split, 1954.
 - [2] Kurian, C. V., Larvae of decapod crustacea from the Adriatic Sea. *Acta Adriatica*. VI(3)1-108, 1956.
 - [3] Lučić, D., Day/night variation in mesozooplankton and macrozooplankton in the Mali Ston Bay. M.Sc. thesis, University of Zagreb. 97, 1985.
 - [4] Lučić, D. and Bender-Pojatina, A., Net zooplankton of Mljet Lakes. *Ekološke monografije*, 6:483-498, 1995.
 - [5] Lučić, D., Annual variability of the decapod larvae community in the shallow waters of the southern Adriatic. *Acta Adriatica*. 39(1):25-30, 1998.
 - [6] Merker, K., Neka preliminarna opažanja na pronalaženju lokaliteta mriješćenja sardele (*Sardina pilchardus* WALB.) na području Južnog Jadrana. *Studia Marina*. 5:61-71, 1971.
 - [7] Števičić, Z., Check-list of the Adriatic decapod Crustacea. *Acta Adriatica*. 31:183-274, 1990.
 - [8] Treguboff, G. and Rose, M., *Manuel de planctnologie Méditerranéenne*. C.N.R.S. Paris. I:580, 1957.
 - [9] Vučetić, T., Zooplankton investigations in the sea Water lakes "Malo jezero" and "Veliko jezero" on the island of Mljet (1952–1953). *Acta Adriatica*. VI(4):1–51, 1957.
- Vukanić, D., La recherches sur la Zooplanktons dans la baie de Kotor. *Nova Thalassia*. 3(1):249–255, 1979.
- Vukanic, V., Zooplankton of the Boka Kotorska Bay – ecology, biodiversity, environment protection. Montenegrin Academy of Sciences and Arts, Spec.ed. (Monographies and Studies) Vol.96; The Section of Natural Sciences Vol.38, p.1-195, 2012.

BIOGRAPHY

PhD Vera Vukanic - is assistant professor on State University of Novi Pazar, Faculty of Biology, whose primary research interest is on marine zooplankton (Copepoda, Cladocera, Medusacea, Appendicularia, Chaetognatha, Decapoda larvae), Marine environment, Marine ecology and Taxonomy. She has written over 50 publications including peer-reviewed papers, book chapters and policy related reports and assessments.

Teaching courses on faculty of Biology: Biology of Invertebrate I and II, Hydrobiology, Zoology, Animal ecology, Essential ecology.

